



SAMSUNG DV M<sup>M</sup> Air Conditioner

# Technical Manual

SAMSUNG ELECTRONICS

# Overview

## 1. DVM system series

- 1-1. What is DVM? ..... 6
- 1-2. Features of DVM ..... 7
- 1-3. DVM vs VAV ..... 12

## 2. DVM line-up

- 2-1. Numbering system of model ..... 14
- 2-2. Combination ..... 20

# Control system

## 1. Remote controller

- 1-1. Wireless remote controller ..... 2
- 1-2. Wired remote controller ..... 4
- 1-3. Centralized controller ..... 6
- 1-4. Function controller ..... 6

## 2. Receiver & display unit (Duct type)

- 2-1. Concealed type ..... 7
- 2-2. Standard type ..... 8

## 3. Transmitter

## 4. Installation

- 4-1. Wireless remote controller ..... 10
- 4-2. Wired remote controller ..... 11
- 4-3. Centralized controller ..... 14
- 4-4. Function controller ..... 19
- 4-5. Receiver & display unit - concealed type ..... 21
- 4-6. Receiver & display unit - standard type ..... 22
- 4-7. Transmitter ..... 23

## 5. Assigning address

- 5-1. Indoor unit ..... 25
- 5-2. Outdoor unit ..... 26

## 6. Indoor unit PCB option code

- 6-1. PCB option code input method ..... 27
- 6-2. Option code ..... 32

## 7. S-Net

## 8. Indoor unit PCB option code

## 9. Building management system

# Indoor unit

## 1. Features

- 1-1. 1-way cassette type ..... 2
- 1-2. 4-way cassette type ..... 4
- 1-3. Duct type ..... 6
- 1-4. Wall-mounted type ..... 8
- 1-5. Floor standing type ..... 10
- 1-6. Ceiling type ..... 12

## 2. Specification

- 2-1. 1-way cassette type ..... 14
- 2-2. 4-way cassette type ..... 16
- 2-3. Duct type (Low silhouette) ..... 18
- 2-4. Duct type (Built-in) ..... 20
- 2-5. Duct type (High pressure) ..... 24
- 2-6. Wall-mounted type ..... 26
- 2-7. Floor standing type ..... 30
- 2-8. Ceiling type ..... 32

## 3. Functional parts and safety devices

- 3-1. 1-way cassette type ..... 34
- 3-2. 4-way cassette type ..... 34
- 3-3. Duct type (Low silhouette) ..... 35
- 3-4. Duct type (Built-in) ..... 36
- 3-5. Duct type (High pressure) ..... 36
- 3-6. Wall-mounted type ..... 37
- 3-7. Floor standing type ..... 38
- 3-8. Ceiling type ..... 38

## 4. Capacity table

- 4-1. 50Hz ..... 39
- 4-2. 60Hz ..... 45

## 5. Dimension

- 5-1. 1-way cassette type ..... 51
- 5-2. 4-way cassette type ..... 52
- 5-3. Duct type (Low silhouette) ..... 54
- 5-4. Duct type (Built-in) ..... 55
- 5-5. Duct type (High pressure) ..... 57
- 5-6. Wall-mounted type ..... 58
- 5-7. Floor standing type ..... 60
- 5-8. Ceiling type ..... 61
- 5-9. Wireless remote controller / Receiver ..... 62
- 5-10. Wired remote controller ..... 70
- 5-11. Option controller ..... 72

# IV Outdoor unit

# V Installation

## 6. Refrigerant system diagram (Cooling only & heat pump)

- 6-1. Refrigerant system diagram ..... 73
- 6-2. Main parts status ..... 73

## 7. Electric circuit diagram

- 7-1. 1-way cassette type ..... 74
- 7-2. 4-way cassette type ..... 76
- 7-3. Duct type ..... 78
- 7-4. Wall-mounted type ..... 80
- 7-5. Floor standing type ..... 82
- 7-6. Ceiling type ..... 84

## 8. Noise level

- 8-1. Overall ..... 86
- 8-2. Octave band level ..... 87

## 9. Velocity of air flow & temperature distribution

- 9-1. 1-way cassette type ..... 102
- 9-2. 4-way cassette type ..... 103
- 9-3. Wall-mounted type ..... 105
- 9-4. Ceiling type ..... 107

## 10. Fan specifications

- 10-1. Duct type(Low silhouette)..... 108
- 10-2. Duct type(Built-in) ..... 109
- 10-3. Duct type(High pressure)..... 110

## 11. Panel

- 11-1. 1-way cassette type ..... 111
- 11-2. 4-way cassette type ..... 112

## 12. Electronic expansion valve kit

- 12-1. Design ..... 113
- 12-2. Status depending on the  
combination ..... 113

## 13. Options

## 1. Unit selection (with cooling load)

## 2. Specification

- 2-1. 50Hz ..... 4
- 2-2. 60Hz ..... 6

## 3. Functional parts and safety devices

- 3-1. Outdoor unit ..... 8
- 3-2. Super cooler ..... 13

## 4. Capacity table

- 4-1. 50Hz ..... 14
- 4-2. 60Hz ..... 20

## 5. Dimension

- 5-1. Upward (2-FAN) ..... 31
- 5-2. Onward ..... 32
- 5-3. Upward (1-FAN) ..... 33
- 5-4. Upward (Super cooler) ..... 34

## 6. Refrigerant system diagram

- 6-1. Cooling only ..... 35
- 6-2. Heat pump ..... 38

## 7. Electric circuit diagram

- 7-1. Cooling only ..... 42
- 7-2. Heat pump ..... 44

## 8. Consideration for outdoor unit selection

- 8-1. Change of capacity depending  
on refrigerant piping length ..... 46
- 8-2. Condition of operating  
restriction ..... 47

## 9. Noise level

## 10. Options

## 1. Product

- 1-1. Preparation for installation ..... 2
- 1-2. Deciding on where to install  
the air conditioner ..... 3
- 1-3. Space requirements for the  
air conditioner ..... 4
- 1-4. Accessories ..... 8
- 1-5. Installation ..... 11

## 2. Panel

- 2-1. 1-way cassette type ..... 13
- 2-2. 4-way cassette type ..... 15
- 2-3. Duct type (Built-in) ..... 16

## 3. Connecting the indoor unit refrigerant pipe

## 4. Drain hose installation

## 5. Drain pump installation

- 5-1. Accessories ..... 22
- 5-2. Installation ..... 22

## 6. Wiring

- 6-1. Overall system configuration ..... 23
- 6-2. Cable specification for outdoor unit ..... 24
- 6-3. Connection cord specification ..... 24
- 6-4. Wiring diagram ..... 24
- 6-5. Connection cord wiring diagram ..... 25
- 6-6. Power wiring and communication  
wiring configuration ..... 25
- 6-7. Communication cable connection ..... 26

## 7. Piping and refnet joint selection

- 7-1. Refrigerant piping system diagram ..... 33
- 7-2. Piping selection ..... 33
- 7-3. Refnet joint selection ..... 34

## 8. Charge/recovery of refrigerant

- 8-1. Refrigerant charging ..... 35
- 8-2. Additional refrigerant amount  
calculation method ..... 36
- 8-3. Recovery of refrigerant ..... 37

## 9. Testing operation

## 10. Cautions for refrigerant leaks

# I Overview

---

## 1

### DVM system series

1-1. What is DVM? .....	6
1-2. Features of DVM .....	7
1-3. DVM vs VAV .....	12

## 2

### DVM line-up

2-1. Numbering system of model .....	14
2-2. Combination .....	20

# 1. DVM system series

## 1-1. What is DVM?

The DVM(Digital Variable Multi) air conditioning system is operated by a variable-capacity compressor and is accommodated by multiple evaporators (indoor units). It is touted as the next-generation modular system in the world of high-efficiency air conditioning. It has undoubtedly changed the face of cooling associated with high-storied buildings. It provides a broad range of different applications for settings such as offices, hotels and schools. With its easy installation and simple controlling system, the DVM will more than meet the demands of the air conditioning market.

<p>Duct type (Low silhouette)</p> 	<p>Duct type (Built-in)</p> 
<p>Duct type (High pressure)</p> 	<p>Wall-mounted type</p> 
<p>Floor standing type</p> 	<p>1-way cassette type</p> 
<p>Ceiling type</p> 	<p>4-way cassette type</p> 
<p>Outdoor unit</p> 	

## 1-2. Features of DVM

### (1) Customized air conditioner

- 1) Up to 16 indoor units can be connected to one outdoor unit.
- 2) Indoor units can be combined by various methods, according to each room's use and shape.
- 3) There are several indoor units which can be applied; 1-way cassette type, 4-way cassette type, Ceiling, Duct (Low silhouette, Built-in, High pressure), Wall-mounted and Floor standing type.

### (2) Comparison of DVM with conventional air conditioners

#### 1) DVM air conditioner

- ① Variable capacity (Energy Saving)
- ② Competitive price (Compared with the Inverter type)
- ③ Can be installed in houses / commercial buildings
- ④ Versatile combination of indoor units
- ⑤ Various remote controls

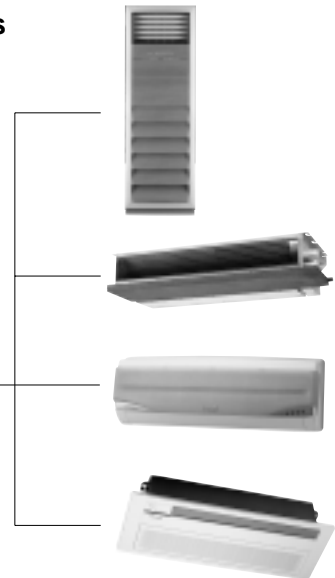

#### 2) Conventional air conditioners

- ① Fixed capacity
- ② Unfavorable in case of installing more than 3 units / system



# 1. DVM system series

## (3) Variable compressor

The world's first PWM(Pulse Width Modulation) compressor controls the cooling & heating capacity automatically, depending on the load.

### 1) Principle of the digital compressor

#### ① Composition

The solenoid valve is installed for the compressor's loading / unloading between the upper part of the fixed scroll and the suction pipe.

#### ② Mechanism

- When the solenoid valve is turned off, the fixed scroll is closed to the orbiting scroll (Loading),
- When the solenoid valve is turned on, the fixed scroll is separated from the orbiting scroll (Unloading),
- This process controls the On / Off times of the valve and the rotating refrigerants in the circle, thus adjusting the capacity.
- The cooling capacity of the outdoor unit is controlled automatically, depending on the number of operating indoor unit(s).

**< 1 Compressor >**

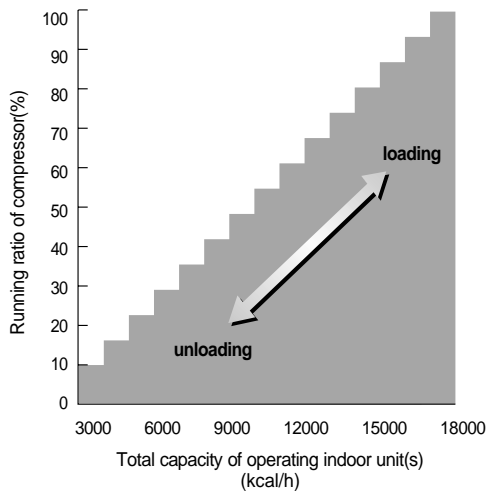

**< 2 Compressor >**

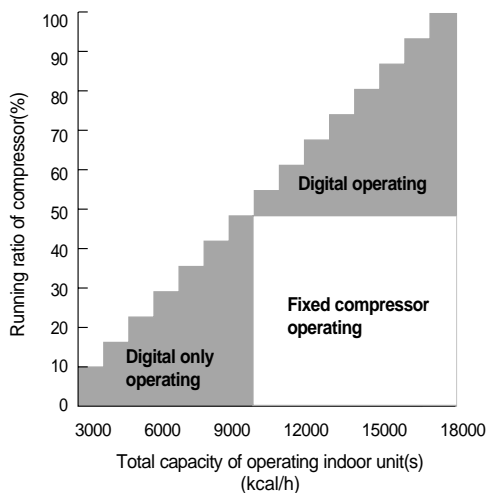

## 2) PWM (Pulse Width Modulation) valve

PWM valve is the valve to take away the fixed scroll by lifting up through the difference of pressure after the digital scroll compress being connected to the outlet and inlet of suction. Therefore, the capacity of compressor is controlled automatically according to the operation status such as loading when the valve is closed or unloading when the valve is open. PWM means the control of ON/OFF signal to the valve for loading/unloading.

### Relationship between PWM valve and loading/unloading

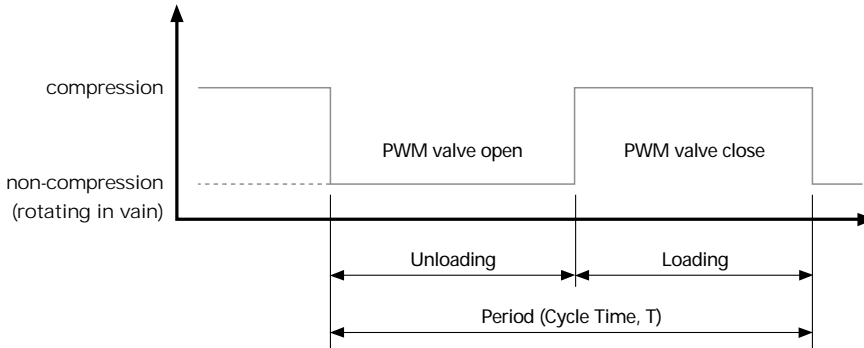

## (4) Refrigerant flow rates control

Refrigerant flow rates through the electronic expansion valve are controlled by the 2 factors which are the temperature difference between inlet and outlet of evaporator and the difference between room and set temperature.

- a. An electronic expansion valve optimally distributes refrigerant flow rates to each room and the fuzzy logic enables comfortable cooling more precisely; refer to the figure below.
- b. The air conditioner senses the temperature difference between inlet and outlet of evaporator, plus the temperature difference between room and set temperature. And it calculates the superheat and the room temperature status, then adjusts refrigerant flow rates after deciding the opening steps of valve.

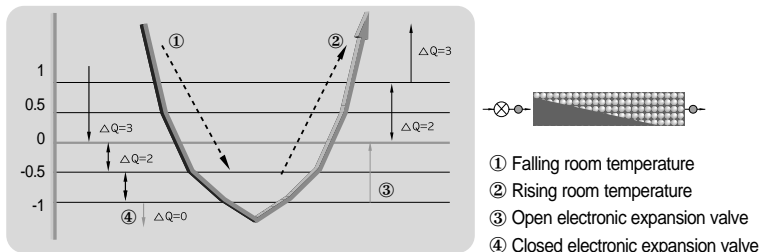

- ① Falling room temperature
- ② Rising room temperature
- ③ Open electronic expansion valve
- ④ Closed electronic expansion valve



# 1. DVM system series

## (5) Long & single piping system

- 1) Piping can be extended up to 100 meters; refer to the figure.
- 2) The outdoor unit is connected with each indoor unit by single refrigerant piping.

## (6) Convenient centralized control

- 1) Every indoor unit has its own remote controller.  
In addition, a maximum of 16 indoor units can be controlled with the centralized controller.
- 2) A maximum of 256 indoor units can be controlled by using the PC Control.

## (7) Easy installation

Simple planning and installation during the early stage of building construction or renovation.

## (8) Minimizing operation costs

The cooling / heating capacity is adjusted automatically with the variable compressor, which reduces power consumption and running costs.

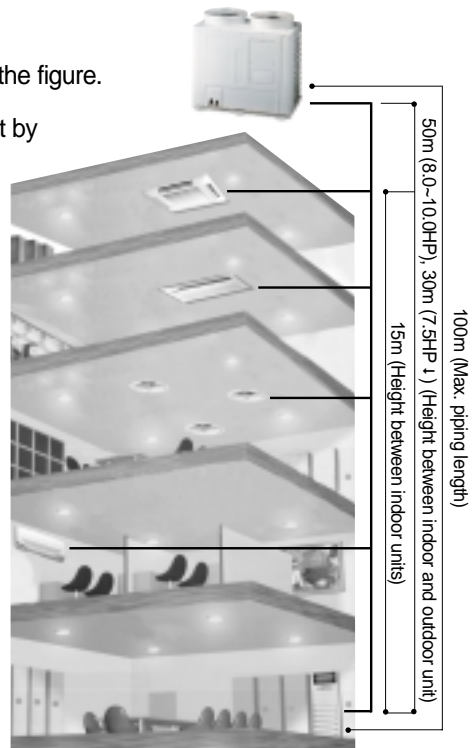

Division		DVM	Chiller	Unitary
Initial cost (US\$)	Equipment	29,812	25,558	27,500
	Piping	17/m <sup>2</sup>	5,111	17/m <sup>2</sup>
	Duct-install		17/m <sup>2</sup>	
	Grand	39,812	40,670	37,500
Running cost (US\$)	Power consumption	44.2kW X 0.8 (Variable Compressor)	43kW X 1.0	52.5kW X 1.0
	Monthly consumption	12,906kWh	15,695kWh	19,162kWh
	Annual consumption (6 months in a year)	77,436kWh	94,170kWh	114,972kWh
	1 year rate	5,575	6,780	8,277
	3 year rate	16,726	20,340	24,833
	5 year rate	27,877	33,900	41,389
	Comparison	100%	121% ↑	148% ↑

\* The results are based on Samsung Lab., therefore there may be differences according to the condition of installation and the environment of the use.

\* Heat loads : 90,000 kcal/h in Korea

\* Total area : 750m<sup>2</sup>

\* Running : 3 months in every summer and winter

## (9) Space Saving

The outdoor units connected with several indoor units do not require much space.

### 1) Conventional System



### 2) DVM System



# 1. DVM system series

## 1-3. DVM vs VAV

### (1) Excellent energy efficiency

Zone control	Test condition	VAV				DVM			
		Opening ratio	Capacity (W)	Power (W)	SEER (W/W)	Opening ratio	Capacity (W)	Power (W)	SEER (W/W)
25%	A	25%	7344	7138	1.134	Max.	5381	2593	1.944
						Min.	3997	1977	
	B		8016	6313		Max.	5510	2353	
						Min.	4365	2073	
50%	A	50%	11997	7353	1.794	Max.	11222	4457	2.478
						Min.	7119	3238	
	B		13015	6486		Max.	11597	4164	
						Min.	8177	3118	
75%	A	75%	15857	7504	2.298	Max.	16692	6190	2.790
						Min.	11666	4630	
	B		16996	6626		Max.	17329	5680	
						Min.	12567	4216	
100%	A	100%	17200	7630	2.492	Max.	19836	7336	2.860
						Min.	15512	5897	
	B		19007	6802		Max.	20786	6666	
						Min.	15880	5152	

\* The results are based on Samsung Lab., therefore there may be differences according to the condition of installation and the environment of the use.

\* Heat loads : 90,000 kcal/h in Korea. The SEER of the DVM is 8-75% higher than the VAV, and increasing the zone control is different from decreasing the SEER.

\* Condition A : DB26.7/WB19.4°C, DB35/WB23.9°C  
 B : DB26.7/WB19.4°C, DB27.8/WB18.3°C

## (2) DVM test condition

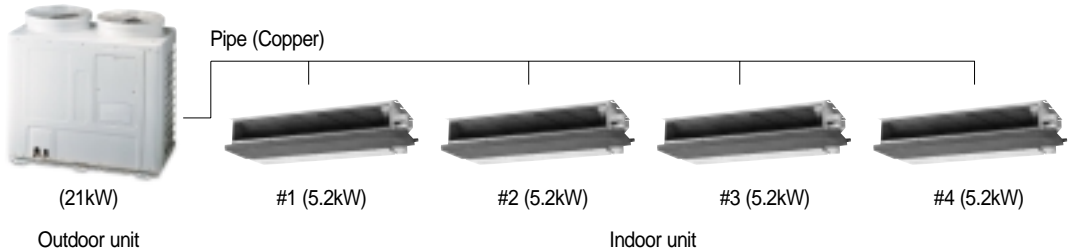

### ■ Zone control conditions

Zone control	Sample #1	Sample #2	Sample #3	Sample #4
25%	On	Off	Off	Off
50%	On	On	Off	Off
75%	On	On	On	Off
100%	On	On	On	On

## (3) VAV test condition

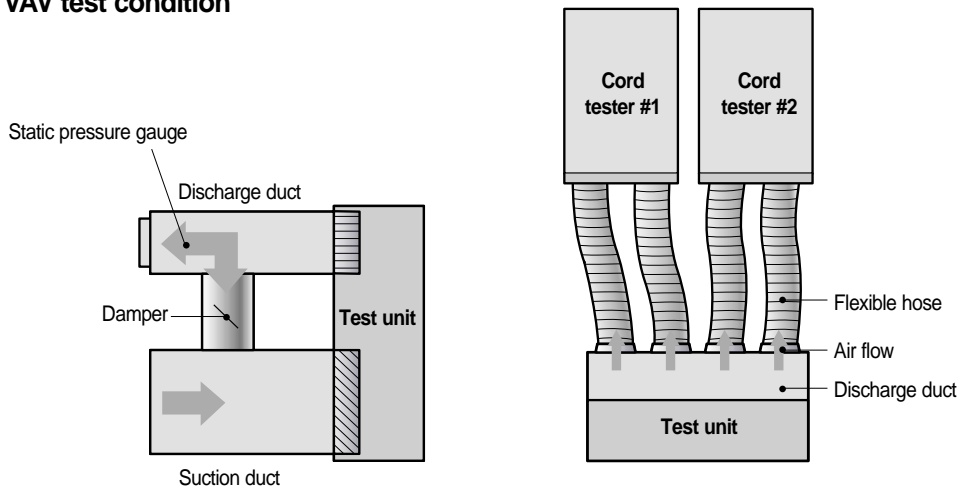

### ■ Zone control conditions

Zone control	No. of duct opening	Zone control	No. of duct opening
25%	1	75%	3
50%	2	100%	4

Outdoor unit : Fixed compressor(21kW)

\* The static pressure is equal to the maximum open position by adjusting the damper.

## 2. DVM line-up

### 2-1. Numbering system of model

#### (1) Indoor unit and outdoor unit (Conventional model)

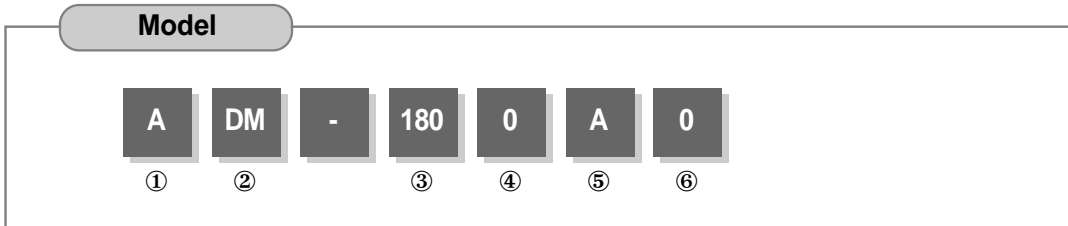

① Semi-finished product

Indoor unit	A
Outdoor unit	M

② Classification of product

1-way cassette type	KM
4-way cassette type	BM
Duct type	DM
Outdoor unit	UF

③ Capacity (Btu x 100)

④ Option

Indoor unit	Function	0
	version	1
Outdoor unit	Recipro	0
	PWM	1

⑤ Power supply

- Indoor unit

115V, 60Hz	A
220V, 60Hz	B
208~230V, 60Hz	C
200~220V, 50Hz	D
220~240V, 50Hz	E
127V, 50Hz	M
220~240V, 50/60Hz, 1ø	N

- Outdoor unit

115V, 60Hz	A
220V, 60Hz	B
208~230V, 60Hz	C
200~220V, 50Hz	D
220~240V, 50Hz	E
220V, 60Hz, 3ø	F
380~415V, 50Hz, 3ø	G
127V, 50Hz	M
220~240V, 50/60Hz, 1ø	N
380V, 60Hz, 3ø	H
460V, 60Hz, 3ø	J

⑥ Version

## (2) Indoor unit and outdoor unit (New Model)

### 1) Indoor unit

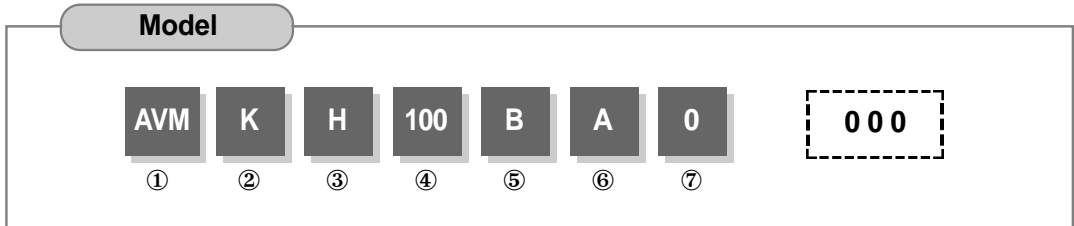

#### ① Semi-finished product

Variable capacity free joint multi (DVM)	AVM
--	-----

#### ③ Mode

Cooling only (C/O)	C
Heat pump (H/P)	H
H/P+Heater	E
C/O+Heater	G
C/O+Hot water heater	N

#### ⑤ Power supply

208~230V, 60Hz	C
220~240V, 50Hz	E

#### ② Classification of product

Cassette type	1-way	K
	4-way	C
	2-way	G
	Exposed	N
Duct type	Low silhouette	D
	High pressure	H
	Built-in	B
Wall-mounted type		W
Ceiling type		F
Floor standing type (PAC)		P

#### ④ Capacity (kW x 100, 3 digits)

Btu/h	Watt	
	50Hz	60Hz
7K	2000W	2000W
9K	2600W	3200W
12K	3500W	4000W
18K	5200W	5200W
20K	6000W	6000W
24K	7000W	7200W
28K	8200W	8300W
36K	10500W	10500W
44K	12800W	12800W
48K	14000W	14000W

#### ⑥ Classification by refrigerant

Refrigerant	Classification
R22	A
R407C	B
R410A	C

#### ⑦ Version

-	0
~	1
~	2

## 2. DVM line-up

### 2) Outdoor unit

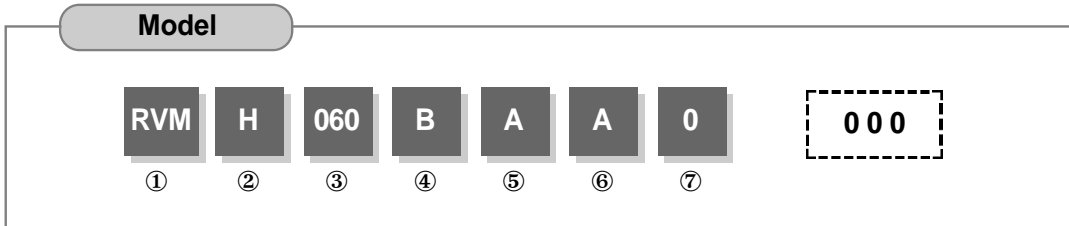

#### ① Semi-finished product

Variable capacity free joint multi (DVM)	RVM
--	-----

#### ④ Power supply

208-230V, 60Hz	C
208-230V, 60Hz, 3ø	F
380-415V, 50Hz, 3ø	G
380V, 60Hz, 3ø	H
460V, 60Hz, 3ø	J

#### ⑥ Combination of indoor unit

Cassette type	1-way	K
	4-way	C
	2-way	G
	Exposed	N
Duct type	Low silhouette	D
	High pressure	H
	Built-in	B
Wall-mounted type		W
Ceiling type		F
Floor standing type (PAC)		P
Free		M

#### ② Mode

Cooling only (C/O)	C
Heat pump (H/P)	H

#### ⑤ Refrigerant / Discharge direction

Refrigerant	Discharge direction	Classification
R22	Upward	A
	Onward	B
R407C	Upward	C
	Onward	D
R410A	Upward	E
	Onward	F

#### ⑦ Version

#### ③ Capacity (HP x 10, 3 digits)

### (3) Options

Parts	Model	Standard for model name	Example
Electronic expansion valve kit	MEV- ① ② ③	MEV : Optional electronic expansion valve ① : Electronic expansion valve model (2 digits) ② : Manufacturer ③ : Version	● MEV-14SA ● MEV-18SA ● MEV-24SA
Distributor kit	MXD- ① ② ③ ④ ⑤	MXD : Optional distributor kit ① : Max diameter (2 digits) ② : Kinds (marked as K2 for two kinds) ③ : Minimum diameter (Marked as 00 only for use of one kind and marked with minimum diameter for use of two kinds) ④ : Kinds (marked as K2 for two kinds) ⑤ : Version	● MXD-14K300A (1/4" 3) ● MXD-14K218A (1/4" 2, 1/8" 1)
Discharge duct	MDF- ① ②	MDF : Optional distributor duct flange ① : Hole size(ø, cm, 2 digits) ② : Version	● MDF-45A
Refnet kit	MXJ- ① ② ③	MXJ : Optional refnet (Y-joint) kit ① : Inlet pipe diameter (2 digits) ② : Outlet pipe diameter (2 digits) ③ : Version	● MXJ-1509B (Inlet pipe 15mm, Outlet pipe 9mm)
Drain pump	MDP- ① ② ③	MDP : Optional drain pump ① : Discharge pressure (cm, 3 digits), 75cm → 075 ② : Manufacturer ③ : Version	● MDP-075SA
Front panel	M ① ② ③ ④ ⑤ ⑥ ⑦	① : Grille application (Front panel) ② : Type of indoor unit (K: 1-Way cassette, G: 2-Way cassette, C: 4-Way cassette, B: Built-in duct) ③ : C: Cooling only, H: heat pump, N: No use of wireless remote controller ④ : Size (Mark the longer side, cm, 3 digits) ⑤ : Color (G: gray, I: Ivory) ⑥ : Language (E: English only, C: Chinese, A: Arabic&English, M: 8 Languages) ⑦ : Version	● MGKC118IE0
Wireless remote controller	MR- ① ② ③ ④	MR : Optional wireless remote controller ① : Design(A~Compact) ② : Mode (C: cooling only, H: heat pump) ③, ④ : Version	● MR-AC00 ● MR-AC00C (For China)





## 2. DVM line-up

Parts	Model	Standard for model name	Example
Receiver & display unit wire	MRW- ① ②	MRW : Optional receiver & display unit wire ① : Length (m, 2 digits) ② : Version	● MRW-10A ● MRW-10AC (For China)
Interface module	MIM- ① ② ③	MIM : Optional interface module ① : Applicable location (A: indoor unit B: outdoor unit, C: others) ②, ③ : Version	● MIM-B00 ● MIM-B00C (For China)
Controller	MCM- ① ② ③ ④	MCM : Optional controller ① : Function (A: controller, B: measuring instrument, C: others) ② : LCD Application (1: yes, 2: none) ③, ④ : Version	● MCM-A200 ● MCM-A200C (For China)
Wired remote controller	MWR- ① ② ③ ④	MWR : Optional wired remote controller ① : Design (A - present) ② : Classification of function (C: cooling only, H: heat pump) ③, ④ : Version	● MWR-AC00 ● MWR-AC00C (For China)
Receiver & display unit kit	MRK- ① ② ③	MRK : Optional receiver & display unit kit ① : Receiver kit design (A) ②, ③ : Version	● MRK-A00 ● MRK-A00C (For China)
Filter	MF- ① ② ③ ④	MF : Optional filter ① : Classification of product ② : Specification of filter (0: air filter 1: bio-pure & deodorizing filter 2: on-board electric dust collector 3: scroll electric dust collector) ③ : Color (B: black G: green) ④ : Version	● MF-C1B0 ● MF-C1B0C (For China)
Duct flange	MDP- ① ② ③ ④	MDP : Duct flange ①, ② : Hole size (ø, cm) ③ : Number of hole ④ : Version	● MDP-2030 ● MDP-2030C (For China)



Parts	Model	Standard for model name	Example
Super cooler	MSC- ① ② ③ ④ ⑤	<p>MSC : Super cooler</p> <p>①, ② : HP of applicable outdoor unit (marked as 00 if it is 10.0 HP)</p> <p>③ : Power supply B:220V, 60Hz C:208~230V, 60Hz E:220~240V, 50Hz H:380V, 60Hz, 3ø J:460V, 60Hz, 3ø</p> <p>④ : Design (A: front B: top)</p> <p>⑤ : Version</p>	<ul style="list-style-type: none"> <li>● MSC-00EB0 (Applied to the top of 10.0HP outdoor unit)</li> <li>● MSC-45EA0 (Applied to the front of 4.5HP outdoor unit)</li> </ul>
Super heater	MSH- ① ② ③ ④ ⑤	<p>MSH : Super heater</p> <p>①, ② : HP of applicable outdoor unit (marked as 00 if it is 10.0 HP)</p> <p>③ : Specification of power source B:220V, 60Hz C:208~230V, 60Hz E:220~240V, 50Hz H:380V, 60Hz, 3ø J:460V, 60Hz, 3ø</p> <p>④ : Design (A: front B: top )</p> <p>⑤ : Version</p>	<ul style="list-style-type: none"> <li>● MSH-00EB0 (Applied to the top of 10.0HP outdoor unit)</li> <li>● MSH-45EA0 (Applied to the front of 4.5HP outdoor unit)</li> </ul>
Water coil	MWC- ① ② ③ ④ ⑤	<p>MWC : Water coil</p> <p>①, ②, ③ : Capacity of applicable indoor unit (x 10 kW)</p> <p>④ : Applicable product (H: High pressure duct, D: Low silhouette duct, B: Built-in duct)</p> <p>⑤ : Version</p>	<ul style="list-style-type: none"> <li>● MWC-083D0 (For 8300W Low silhouette duct)</li> </ul>

## 2. DVM line-up

### 2-2. Combination



#### (1) Outdoor unit

##### 1) Cooling only

Design		Power supply		Model	Capacity(HP)	Refrigerant
Main	Super cooler					
	-	50Hz	380~415V, 3ø	RVMC060GDM0	6	R407C
		60Hz	208~230V, 3ø	RVMC050CBM0	5	R22
		50Hz	380~415V, 3ø	RVMC060GAM0	6	R22
			380~415V, 3ø	RVMC060GAM1	6	R22
		60Hz	380V, 3ø	MUF7201F1	7.5	R22
			208~230V, 3ø	RVMC075FAM0	7.5	R22
	-	50Hz	380~415V, 3ø	RVMC100GAM0	10	R22
			208~230V, 3ø	RVMC080FAM0	8	R22
		60Hz	208~230V, 3ø	RVMC100FAM0	10	R22



- ◆ The system enables the connection of indoor units with a total capacity of between 50 to 130% of that of the corresponding outdoor unit but where this capacity ratio exceeds 100% then the actual capacity of each indoor unit will fall a little short of its individual rated capacity when all the units are operated simultaneously. (Except Middle East models)
- ◆ The specification of super cooler may differ, depending on the model.

Design		Max. connectible indoor units	Total capacity of indoor units (kW, ISO standard)	Super cooler	Remark
Main	Super cooler				
	-	8	8.0-20.8	-	
		7	7.2-18.8	-	
	-	8	8.0-20.8	-	
		8	8.0-16.0	-	For Middle East
		10	10.5-27.3	-	
			10.5-21.0	O	For Middle East
			10.5-27.3	-	
10.5-21.0	-	For Middle East			
	-	14	14.0-36.4	-	
			14.0-28.0	-	For Middle East
		11	11.1-29.0	-	
		14	14.0-36.4	-	
			14.0-28.0	-	For Middle East



- ◆ The system enables the connection of indoor units with a total capacity of between 50 to 130% of that of the corresponding outdoor unit but where this capacity ratio exceeds 100% then the actual capacity of each indoor unit will fall a little short of its individual rated capacity when all the units are operated simultaneously. (Except Middle East models)
- ◆ The specification of super cooler may differ, depending on the model.



## 2. DVM line-up

### 2) Heat pump

Design		Power supply	Model	Capacity(HP)	Refrigerant	
Main	Super cooler					
	-	50Hz	380~415V, 3ø	RVMH060GBM0	6	R22
			380~415V, 3ø	RVMH060GDM0	6	R407C
		60Hz	208~230V, 3ø	RVMH050CBM0	5	R22
	-	50Hz	380~415V, 3ø	RVMH080GAM0	8	R22
			380~415V, 3ø	RVMH100GAM0	10	R22
			380~415V, 3ø	RVMH100GCM0	10	R22
		60Hz	208~230V, 3ø	RVMH100FAM0	10	R22



- ◆ The system enables the connection of indoor units with a total capacity of between 50 to 130% of that of the corresponding outdoor unit but where this capacity ratio exceeds 100% then the actual capacity of each indoor unit will fall a little short of its individual rated capacity when all the units are operated simultaneously. (Except Middle East models)
- ◆ The specification of super cooler may differ, depending on the model.

Design		Max. connectible indoor units	Total capacity of indoor units (kW, ISO standard)	Super cooler	Remark
Main	Super cooler				
	-	8	8.0~20.8	-	
		8	8.0~20.8	-	
		7	7.2~18.8	-	
	-	11	11.0~29.0	-	
		14	14.0~36.4	-	
			14.0~28.0	-	For Middle East
		14	14.0~36.4	-	
		14	14.0~36.4	-	
14.0~28.0	-		For Middle East		



- ◆ The system enables the connection of indoor units with a total capacity of between 50 to 130% of that of the corresponding outdoor unit but where this capacity ratio exceeds 100% then the actual capacity of each indoor unit will fall a little short of its individual rated capacity when all the units are operated simultaneously. (Except Middle East models)
- ◆ The specification of super cooler may differ, depending on the model.

# 1. System line-up

## (2) Indoor unit

Design	Power supply	2.0kW (7000Btu/h)	2.6kW (9000Btu/h)	3.2kW (11000Btu/h)	3.5kW (12000Btu/h)	4.0kW (13500Btu/h)	5.2kW (18000Btu/h)	6.0kW (20000Btu/h)
1-way cassette type 	50Hz	AVMKC020EA0	AVMKC026EA0	-	AVMKC035EA0	-	-	-
		AVMKH020EA0	AVMKH026EA0	-	AVMKH035EA0	-	-	-
	60Hz	AVMKC020CA0	-	AVMKC032CA0	-	AVMKC040CA0	-	-
		AVMKH020CA0	-	AVMKH032CA0	-	AVMKH040CA0	-	-
4-way cassette type 	50Hz	-	-	-	-	-	AVMCC052EA0	-
		-	-	-	-	-	AVMCH052EA0	-
	60Hz	-	-	-	-	-	AVMCC052CA0	-
		-	-	-	-	-	ABM1800B1 AVMCH052CA0	-
Duct type(Low silhouette) 	50Hz	-	-	-	-	-	AVMDC052EA0	-
		-	-	-	-	-	AVMDH052EA0	-
	60Hz	-	-	-	-	-	AVMDC052CA0	-
		-	-	-	-	-	ADM1800B1 AVMDH052CA0	-
Duct type (Built-in) 	50Hz	AVMBC020EA0	AVMBC026EA0	-	AVMBC035EA0	-	AVMBC052EA0	-
		AVMBH020EA0	AVMBH026EA0	-	AVMBH035EA0	-	AVMBH052EA0	-
	60Hz	AVMBC020CA0	-	AVMBC032CA0	-	AVMBC040CA0	AVMBC052CA0	-
		AVMBH020CA0	-	AVMBH032CA0	-	AVMBH040CA0	AVMBH052CA0	-
Duct type(High pressure) 	50Hz	-	-	-	-	-	-	-
		-	-	-	-	-	-	-
	60Hz	-	-	-	-	-	-	-
		-	-	-	-	-	-	-
Wall-mounted type 	50Hz	AVMWC020EA0	AVMWC026EA0	-	AVMWC035EA0	-	AVMWC052EA0	-
		AVMWH020EA0	AVMWH026EA0	-	AVMWH035EA0	-	AVMWH052EA0	-
	60Hz	AVMWC020CA0	-	AVMWC032CA0	-	AVMWC040CA0	AVMWC052CA0	-
		AVMWH020CA0	-	AVMWH032CA0	-	AVMWH040CA0	AVMWH052CA0	-
Floor standing type 	50Hz	-	-	-	-	-	-	AVMPC060EA0
		-	-	-	-	-	-	AVMPH060EA0
	60Hz	-	-	-	-	-	-	AVMPC060CA0
		-	-	-	-	-	-	AVMPH060CA0
Ceiling type 	50Hz	-	-	-	-	-	AVMFC052EA0	-
		-	-	-	-	-	AVMFH052EA0	-
	60Hz	-	-	-	-	-	AVMFC052CA0	-
		-	-	-	-	-	AVMFH052CA0	-

 \*Caution\* ◆ The design and capacity of indoor unit are subject to change without notice.

Design	Power supply	7.0kW (24000Btu/h)	7.2kW (24000Btu/h)	8.2kW (28000Btu/h)	8.3kW (28000Btu/h)	10.5kW (36000Btu/h)	12.8kW (44000Btu/h)	Remark	
1-way cassette type 	50Hz	-	-	-	-	-	-		
		-	-	-	-	-	-		
	60Hz	-	-	-	-	-	-		
		-	-	-	-	-	-		
4-way cassette type 	50Hz	AVMCC070EA0	-	-	-	AVMCC105EA0	-		
		AVMCH070EA0	-	-	-	AVMCH105EA0	-		
	60Hz	-	AVMCC072CA0 ABM2400B1 AVMCH072CA0	-	-	AVMCC105CA0	-		
		-	-	-	-	AVMCH105CA0	-		
Duct type (Low silhouette) 	50Hz	AVMDC070EA0	-	-	-	-	-		
		AVMDH070EA0	-	-	-	-	-		
	60Hz	-	AVMDC072CA0 ADM2400B1 AVMDH072CA0	-	-	-	-	-	
		-	-	-	-	-	-	-	
Duct type (Built-in) 	50Hz	AVMBC070EA0	-	-	-	-	-		
		AVMBH070EA0	-	-	-	-	-		
	60Hz	-	AVMBC072CA0	-	-	-	-	-	
		-	AVMBH072CA0	-	-	-	-	-	
Duct type (High pressure) 	50Hz	-	-	-	-	AVMHC105EA0	AVMHC128EA0		
		-	-	-	-	AVMHH105EA0	AVMHH128EA0		
	60Hz	-	-	-	-	AVMHC105CA0	AVMHC128CA0		
		-	-	-	-	AVMHH105CA0	AVMHH128CA0		
Wall-mounted type 	50Hz	AVMWC070EA0	-	-	-	-	-		
		AVMWH070EA0	-	-	-	-	-		
	60Hz	-	AVMWC072CA0	-	-	-	-	-	
		-	AVMWH072CA0	-	-	-	-	-	
Floor standing type 	50Hz	AVMPC070EA0	-	AVMPC082EA0	-	-	-		
		AVMPH070EA0	-	AVMPH082EA0	-	-	-		
	60Hz	-	AVMPC072CA0	-	AVMPC083CA0	-	-		
		-	AVMPH072CA0	-	AVMPH083CA0	-	-		
Ceiling type 	50Hz	AVMFC070EA0	-	-	-	-	-		
		AVMFH070EA0	-	-	-	-	-		
	60Hz	-	AVMFC072CA0	-	-	-	-	-	
		-	AVMFH072CA0	-	-	-	-	-	

**\*Caution\*** ◆ The design and capacity of indoor unit are subject to change without notice.



# II Control System

1	Remote controller	
	1-1. Wireless remote controller .....	2
	1-2. Wired remote controller .....	4
	1-3. Centralized controller .....	6
	1-4. Function controller .....	6
2	Receiver & display unit (Duct type)	
	2-1. Concealed type .....	7
	2-2. Standard type .....	8
3	Transmitter	
4	Installation	
	4-1. Wireless remote controller .....	10
	4-2. Wired remote controller .....	11
	4-3. Centralized controller .....	14
	4-4. Function controller .....	19
	4-5. Receiver & display unit - concealed type .....	21
	4-6. Receiver & display unit - standard type .....	22
	4-7. Transmitter .....	23
5	Assigning address	
	5-1. Indoor unit .....	25
	5-2. Outdoor unit .....	26
6	Indoor unit PCB option code	
	6-1. PCB option code input method .....	27
	6-2. Option code .....	32
7	S-Net	
8	Integrating power distribution system	
9	Building management system	



# 1. Remote controller

## 1-1. Wireless remote controller

### (1) 1-way / 4-way cassette / Wall-mounted / Floor standing / Ceiling type

1) Cooling only (MR-AC01)

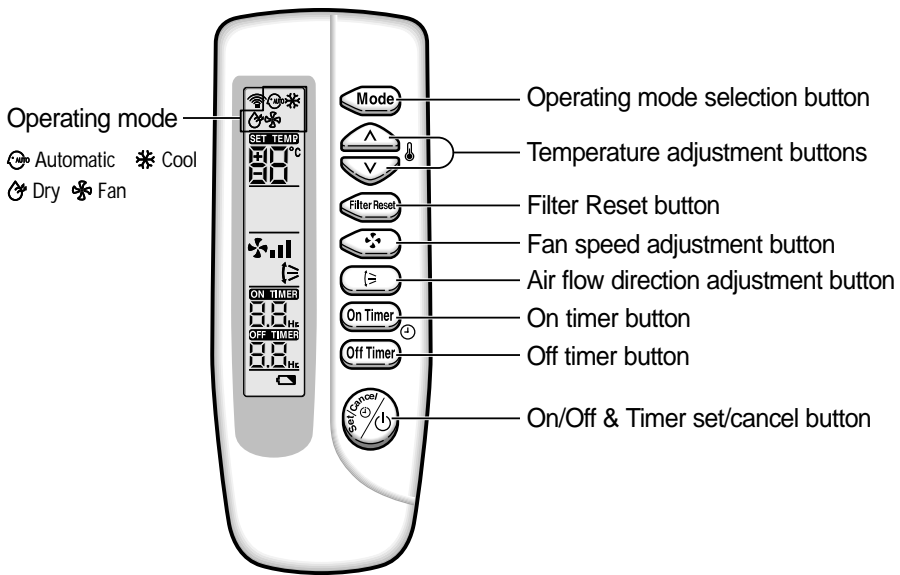

2) Heat pump

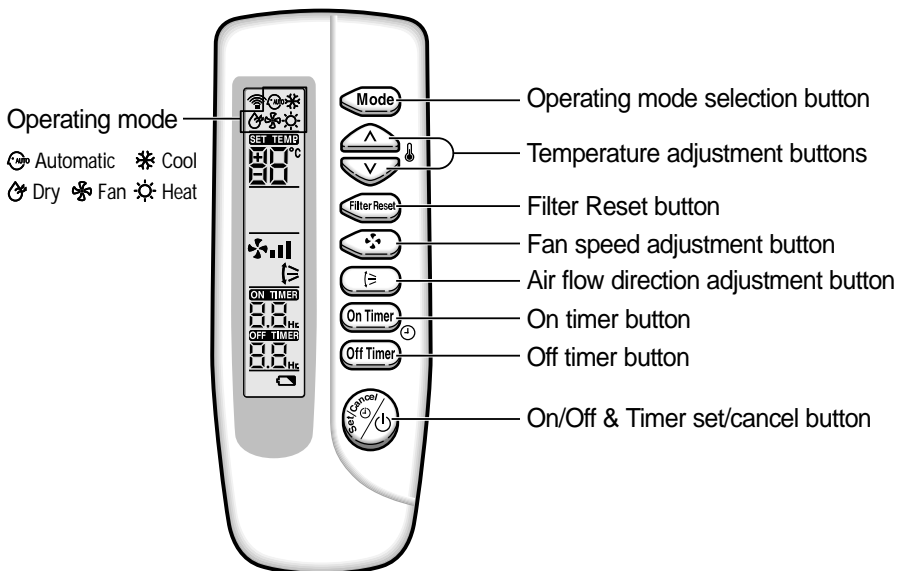

## (2) Duct type

### 1) Cooling only

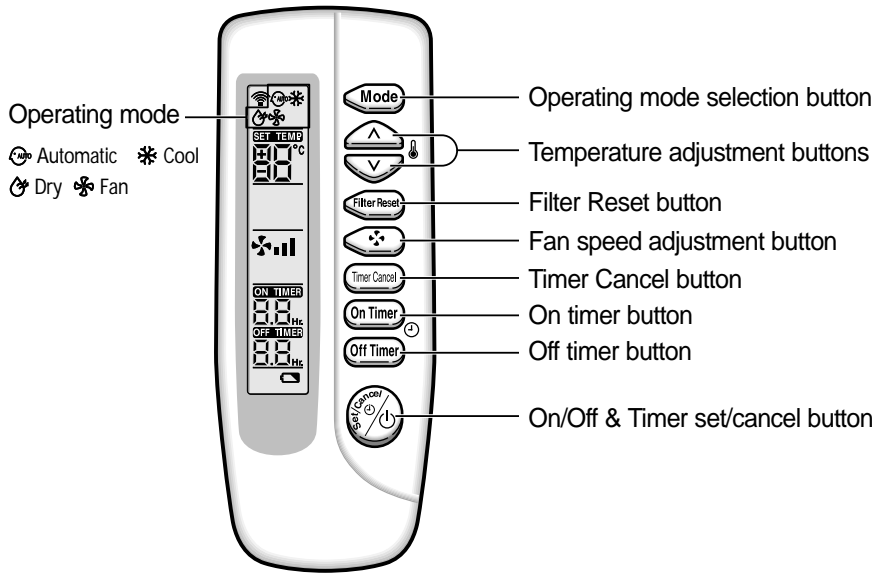

### 2) Heat pump

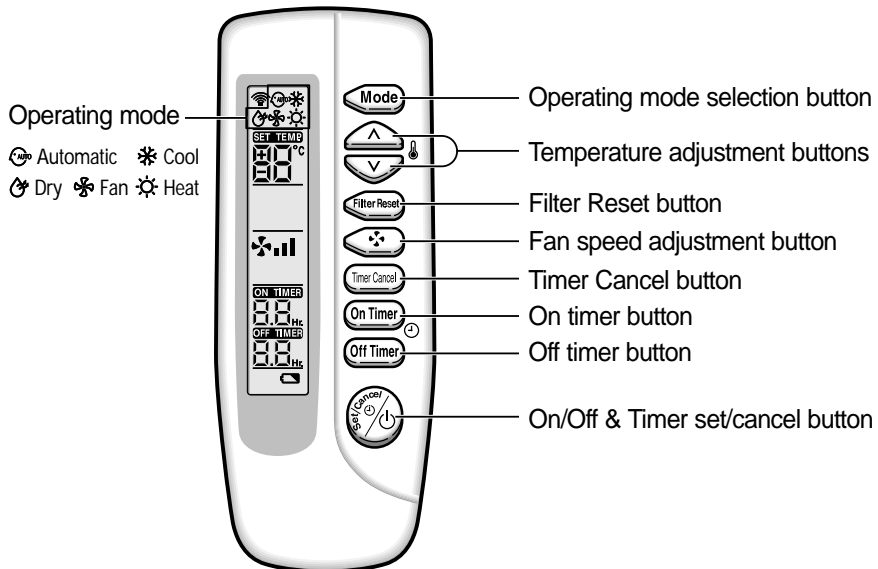



# 1. Remote controller

## 1-2. Wired remote controller

### (1) 1-way / 4-way cassette / Wall-mounted / Floor standing / Ceiling type

1) Cooling only

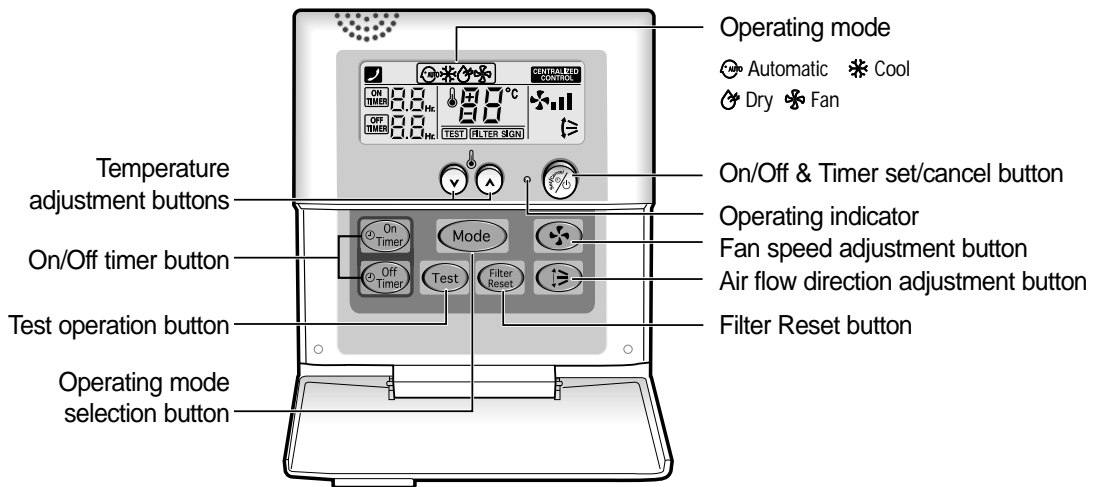

2) Heat pump

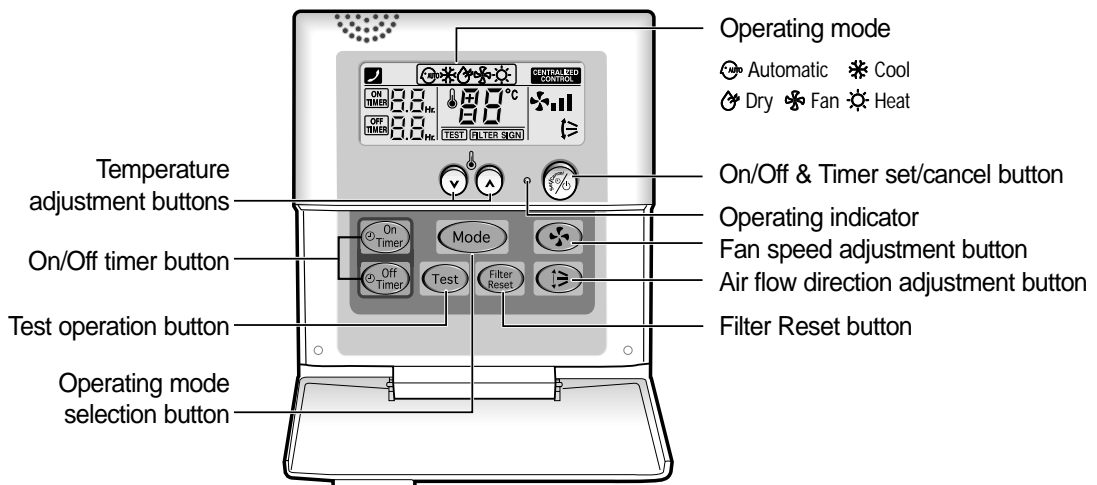

## (2) Duct type

### 1) Cooling only

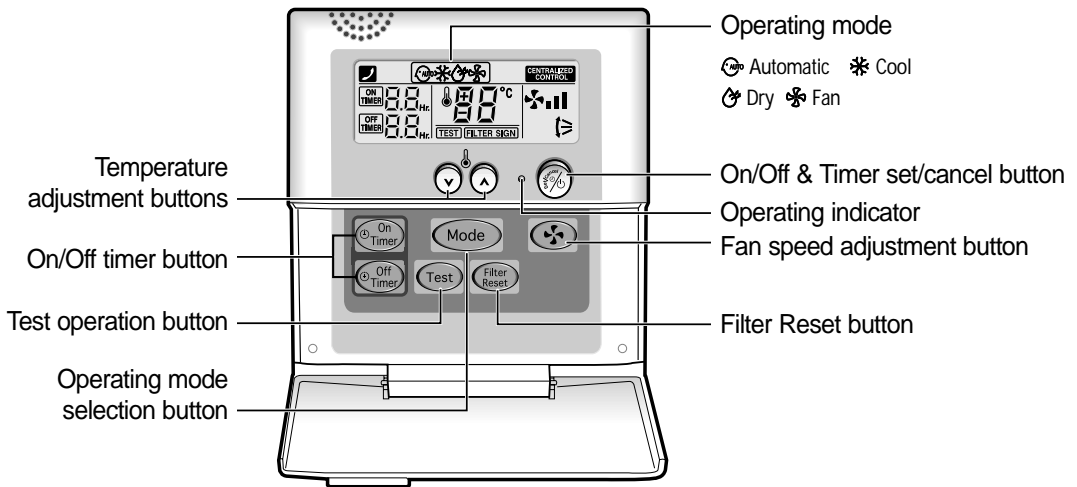

### 2) Heat pump

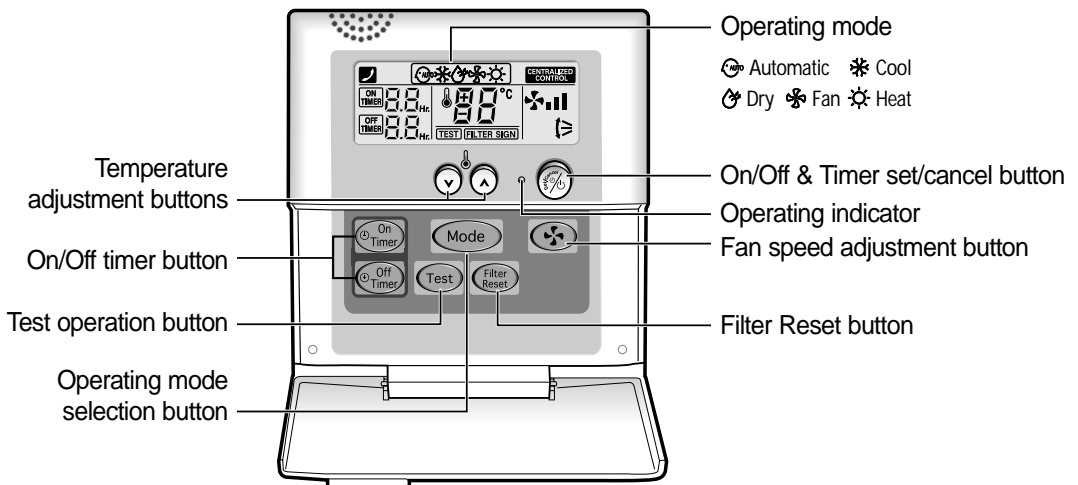



# 1. Remote controller

## 1-3. Centralized controller

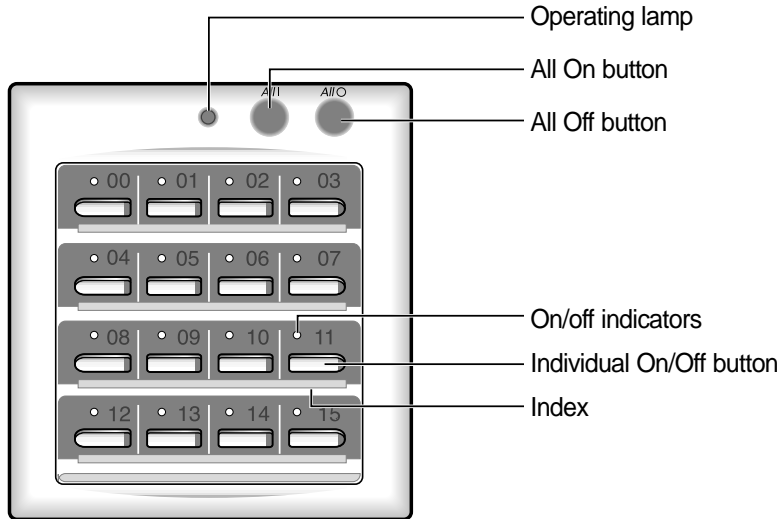

## 1-4. Function controller

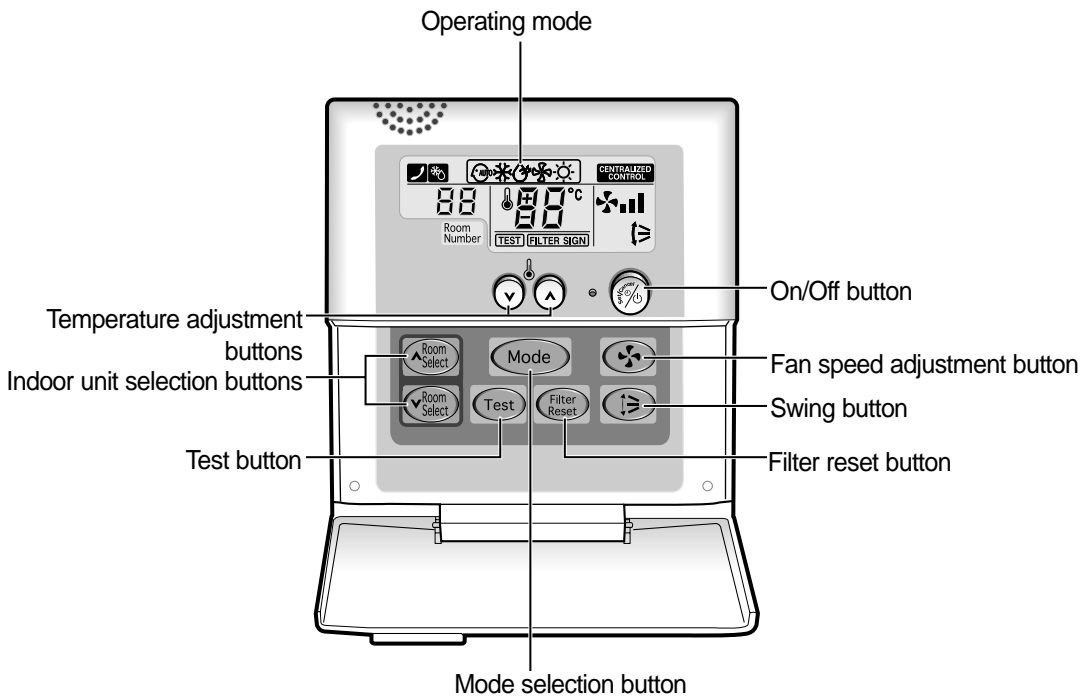

## 2. Receiver & display unit (Duct type)

### 2-1. Concealed type

#### (1) Cooling only

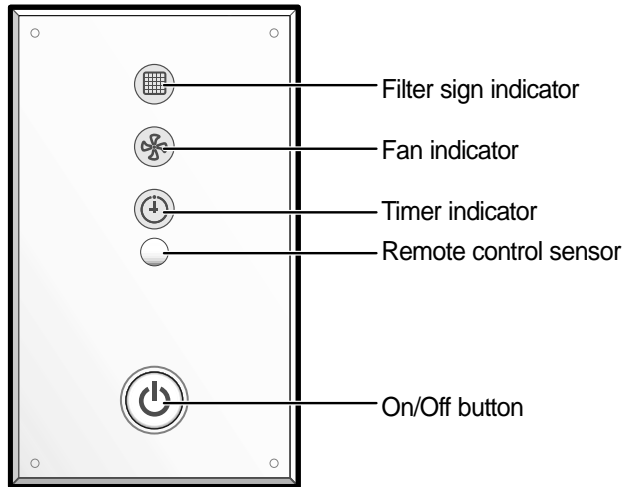

#### (2) Heat pump

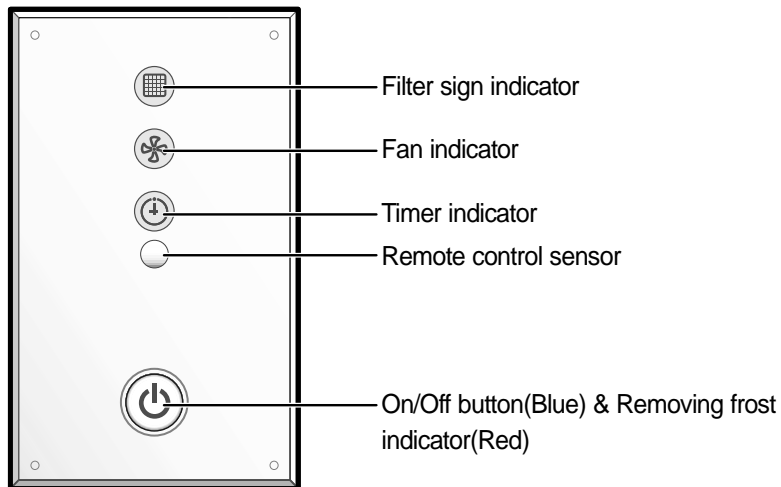

#### Note

- ◆ The shape of receiver & display unit for cooling model is same with heat pump's. But their function and color of indicators are different each other.
- ◆ This receiver & display unit should be applied to duct type air conditioners when using the wireless remote controller, and the receiver & display unit wire kit must be purchased together.



## 2. Receiver & display unit (Duct type)

### 2-2. Standard type

#### (1) Cooling only

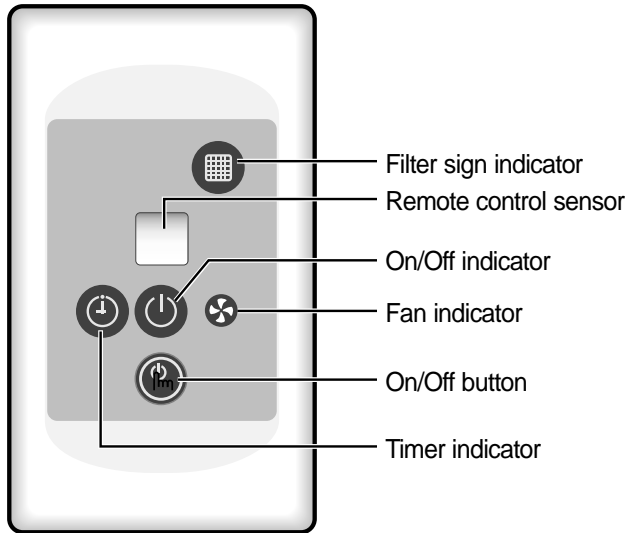

#### (2) Heat pump

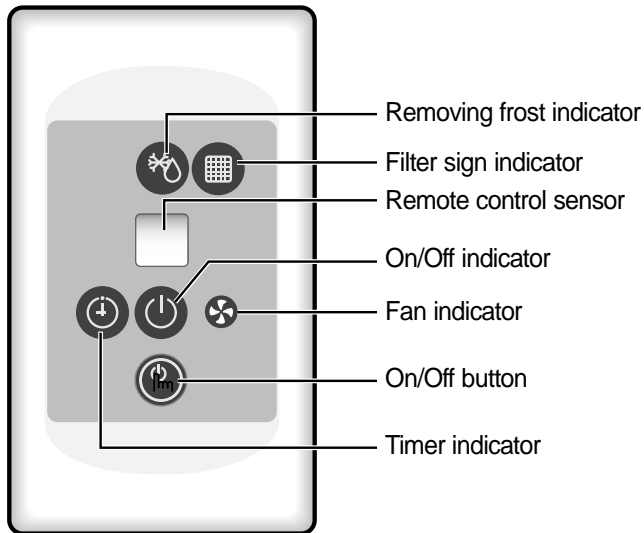

◆ This receiver & display unit should be applied to duct type air conditioners when using the wireless remote controller, and the receiver & display unit wire kit must be purchased together.



### 3. Transmitter

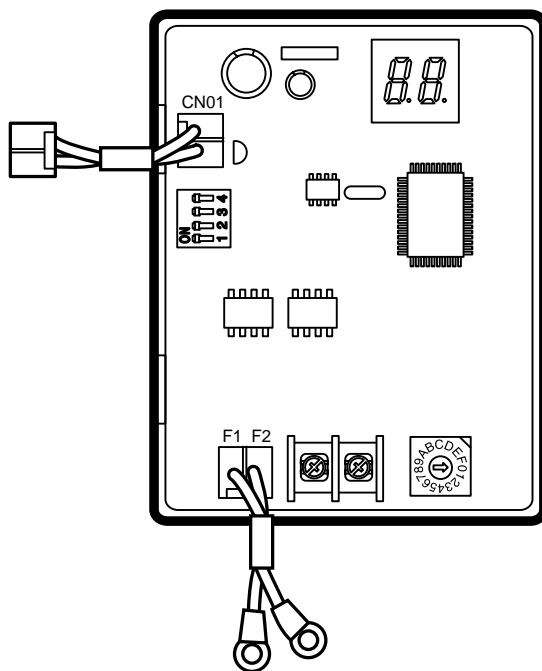









## 4. Installation

### 4-1. Wireless remote controller

#### (1) Accessories

Wireless remote controller(1) 	Battery for wireless remote controller(2) 	M4x12 tapped screw(2) 	Remote control holder(1) 	Owner's instructions(1) 	Installation manual(1) 
--	--	--	---	---	---

#### (2) Installation

Choose a position where:

- ◆ The signal from the remote controller will not be blocked (by a curtain for example)
- ◆ The remote controller is not exposed to direct sunlight or heat
- ◆ The wireless remote controller is at least one meter away from a television or stereo system to avoid generating any parasites





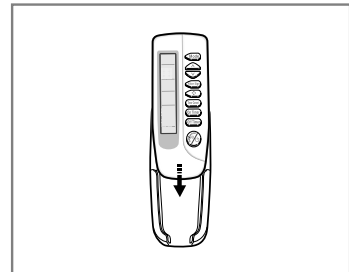
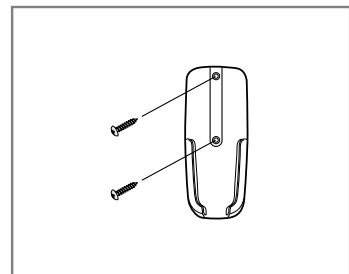

To attach the holder to the wall, proceed as follows.

- 1) With a pencil, mark the positions of the two holes on the wall where the holder is to be installed.
- 2) Drill the two holes and insert plugs as required for the type of wall on which the holder is being installed.
- 3) Screw the holder into position.



## 4-2. Wired remote controller

### (1) Accessories

Wired Remote Controller (1) 	Cable-Tie(2) 	Cable Clamp (5) 	M4x16 Tapped Screw (7) 	Indoor Unit Power Drawing Cable (1) 	Owner's instructions(1) 	Installation manual (1) 
--	---	--	---	--	--	--

### (2) Installation

- 1) Open the wired remote controller by using two grooves on its top.
- 2) Secure the rear cover of the wired remote controller on the wall with 2 screws.
- 3) Connect each F1, F2, V1, and V2 terminal on the wired remote controller PCB to the indoor unit.
- 4) Reassemble the wired remote controller.
- 5) In case of 1-way Cassette type, connect terminals with the main PCB of indoor unit as shown at the figure.

**Note** ◆ Be careful about the cables so that they will not be mixed up.

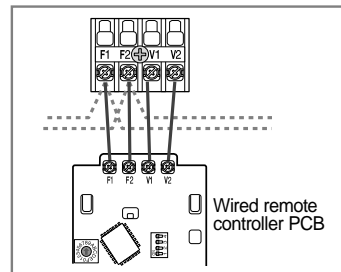
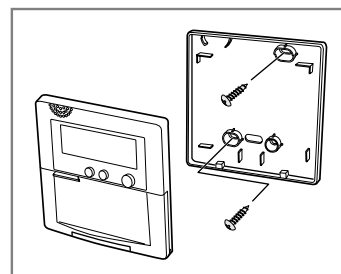
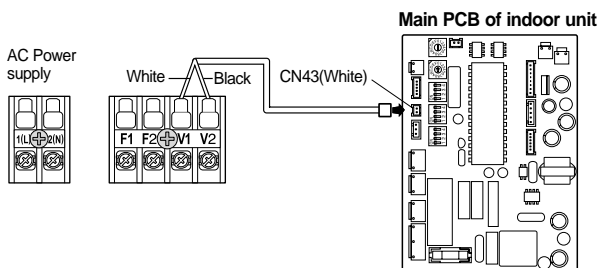

- ◆ The wired remote controller must be installed by an installation specialist.
- ◆ Before installing the wired remote controller, ensure that you have turned off the main power.
- ◆ All wired remote controller cables should be installed according to the national wiring rules and you must install it in the wall not to be touched by users.



## 4. Installation

### (3) Setting up option switches

#### Indoor unit PCB

- 1) Adjust K1 DIP switch(SW03) on the PCB to the "OFF" position.

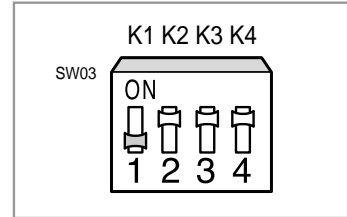

- 2) Turn the arrow of RMC rotary switch(SW01) to the appropriate position.

Result : It is controlled by a wired remote controller which has the same address.

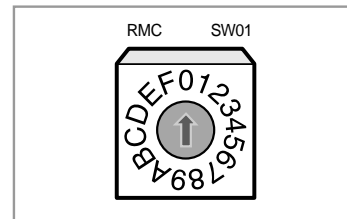

#### Wired remote controller PCB

- 1) Assign an address to the wired remote controller by turning the arrow of rotary switch.

**Note** ♦ The address of wired remote controller and the RMC address of indoor units should be the same.

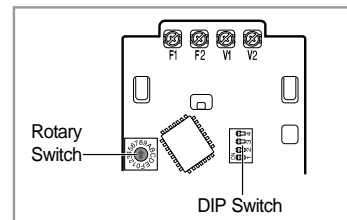

- 2) Adjust the DIP switch to appropriate position.  
Refer to the table below.

Switch No.	OFF	ON	Original Position
1	Cooling only	Cooling and Heating	ON
2	-	-	OFF
3	°C display	°F display	OFF
4	Can be used wired and wireless remote controller (Slave mode)	Can be used wired remote controller only (Master mode)	OFF



- ♦ All indoor units you wish to control with wired remote controller must have the same RMC address.
- ♦ Indoor units controlled with the same wired remote controller should be connected to the same outdoor unit and must have different MAIN addresses.
- ♦ If you would like to use the wired remote controller and the centralized controller together, refer to page II-16.

#### (4) Example of installing wired remote controller

##### Individual control

Means a wired remote controller controls only 1 indoor unit. In this case, the RMC address of the indoor unit should be the same with the address of wired remote controller.

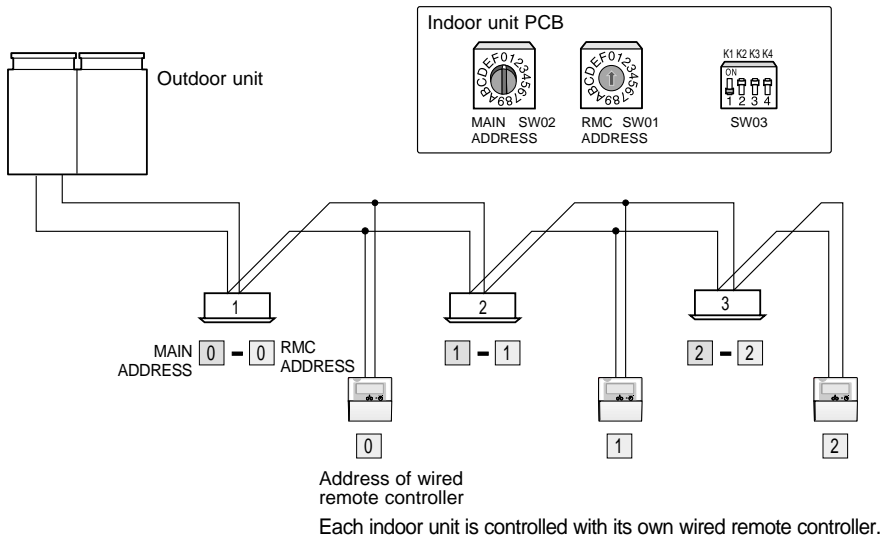

##### Individual & Group control



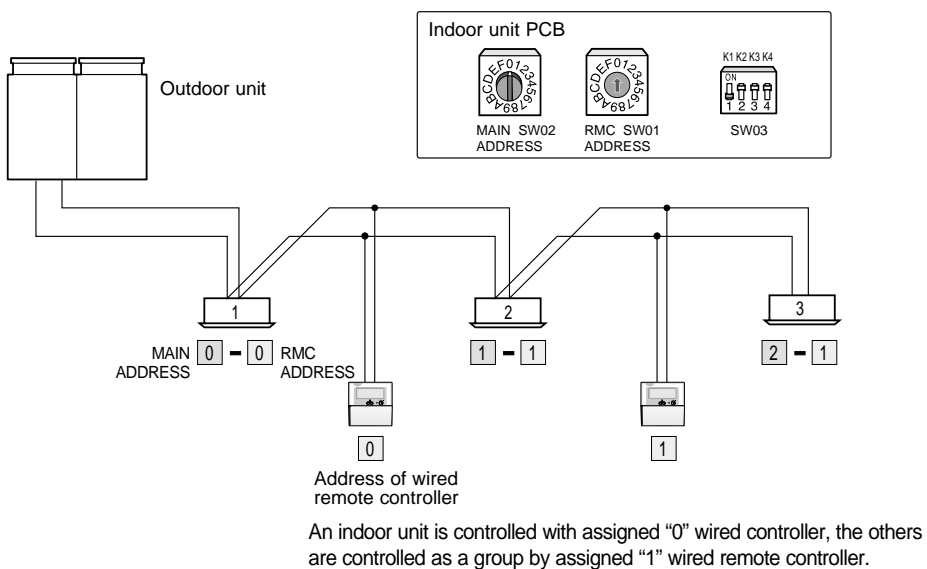



Means a wired remote controller controls more than 2 indoor units. In this case, the RMC address of all indoor units to be controlled by the wired remote controller should be the same with the address of wired remote controller.



# 4. Installation

## 4-3. Centralized controller

### (1) Accessories

Centralized Controller (1) 	Cable-tie (2) 	Cable Clamp (5) 	M4x16 Tapped Screw (7) 	Owner's instructions(1) 	Installation manual(1) 
---	--	--	---	---	---

**Note** ♦ If you would like to install the centralized controller, you must install the optional transmitter in the outdoor unit.

### (2) Wiring diagram

Each outdoor unit connected to the same centralized controller must have its own transmitter.

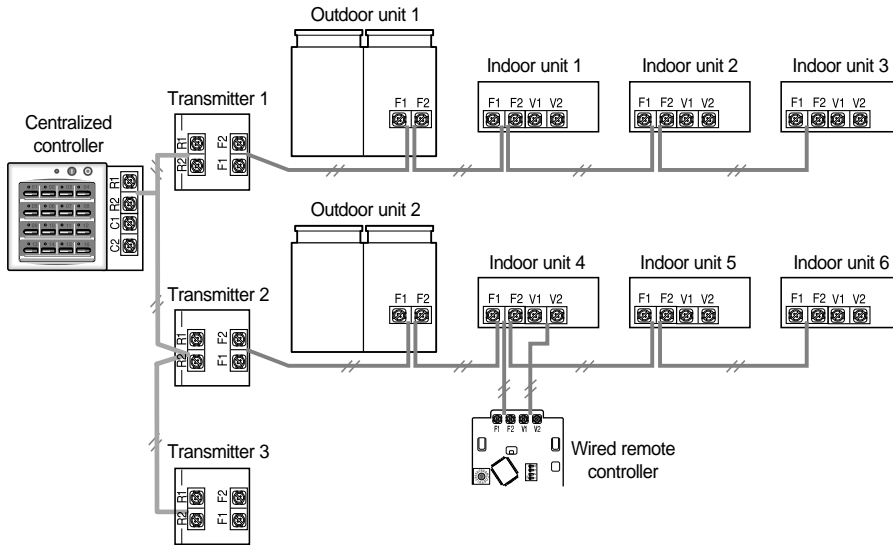

### (3) Transmitter installation

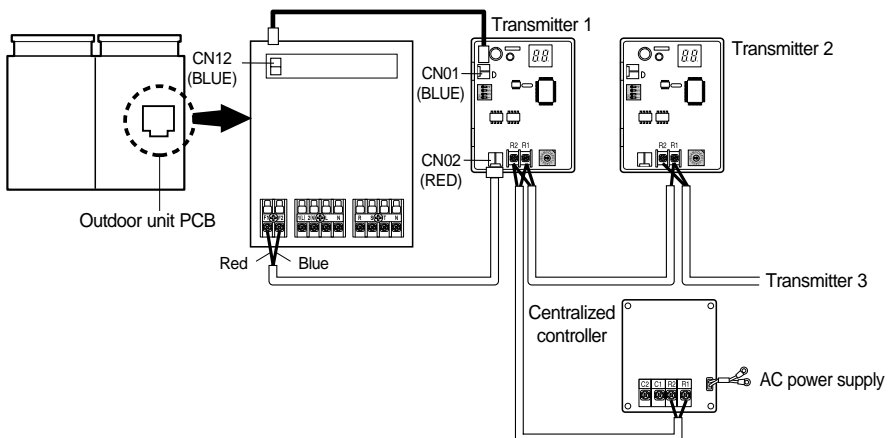

#### (4) Assigning address

Turn the arrow of rotary switch on the transmitter to appropriate position. Transmitters controlled with the same centralized controller must have different addresses.

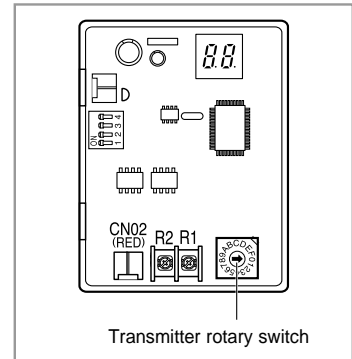

#### (5) Setting up option switches

##### In case of installing centralized controller only

Adjust K2 DIP switch(SW03) on the indoor unit PCB to the "OFF" position. It means use of the centralized controller.

**Note** ♦ The number of button on the centralized controller is decided by the RMC addresses of indoor units. Refer to the table below.

Button No.	RMC Address	Button No.	RMC Address
0	0	8	8
1	1	9	9
2	2	10	A
3	3	11	B
4	4	12	C
5	5	13	D
6	6	14	E
7	7	15	F

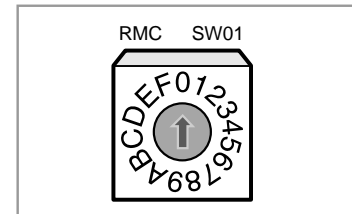
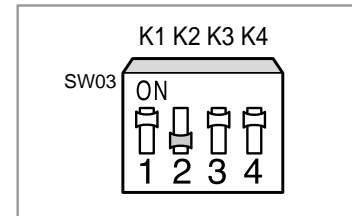

**Note** Individual control ;

♦ Means a centralized controller controls only 1 indoor unit. In this case, you should assign the RMC address to the indoor unit.

Group control ;

♦ Means a centralized controller controls more than 2 indoor units. In this case, you should assign the RMC address to each indoor unit to be controlled by the centralized controller and cannot use a wireless remote controller.



# 4. Installation

## In Case of Installing wired remote controller together

1) Adjust K2 DIP switch(SW03) on the indoor unit PCB to the "OFF" position. It means use of the centralized controller.

**Note** ♦ The number of button on the centralized controller is decided by the RMC addresses of indoor units. Refer to the table below.

Button No.	RMC Address	Button No.	RMC Address
0	0	8	8
1	1	9	9
2	2	10	A
3	3	11	B
4	4	12	C
5	5	13	D
6	6	14	E
7	7	15	F

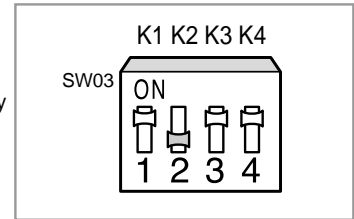

2) Adjust K1 DIP switch(SW03) on the indoor unit PCB to the "OFF" position. It means use of the wired remote controller.

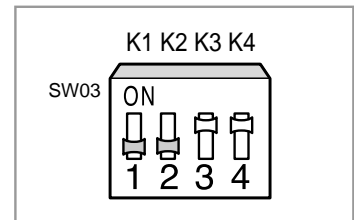

3) Assign an address to the wired remote controller by turning the arrow of rotary switch.

**Note** ♦ The address of wired remote controller and the RMC address of indoor units should be the same.

**Example** If an indoor unit's RMC address is '0', the indoor unit will be operated by the address '0' wired remote controller and the address '0' centralized controller.

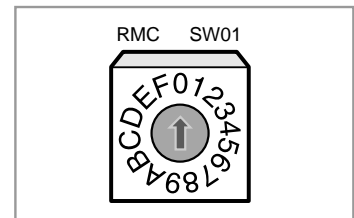

- ♦ A group is made up of indoor units controlled with the same wired remote controller.
- ♦ If the wired remote controller is installed for group controlling, you can install/use the centralized controller to control the same group.



## (6) Example of centralized controller & wired remote controller

Installation of 1 centralized controller, 4 outdoor units, and 12 indoor units

- ◆ 6 indoor units connected to the outdoor unit 1 and 2 are controlled with their own wired remote controller and a centralized controller.
- ◆ 3 indoor units connected to the outdoor unit 3 are controlled as a group by a wired remote controller and a centralized controller.
- ◆ 2 indoor units connected to the outdoor unit 4 are controlled a wired remote controller and a centralized controller, the other indoor unit is only controlled by a wired remote controller.

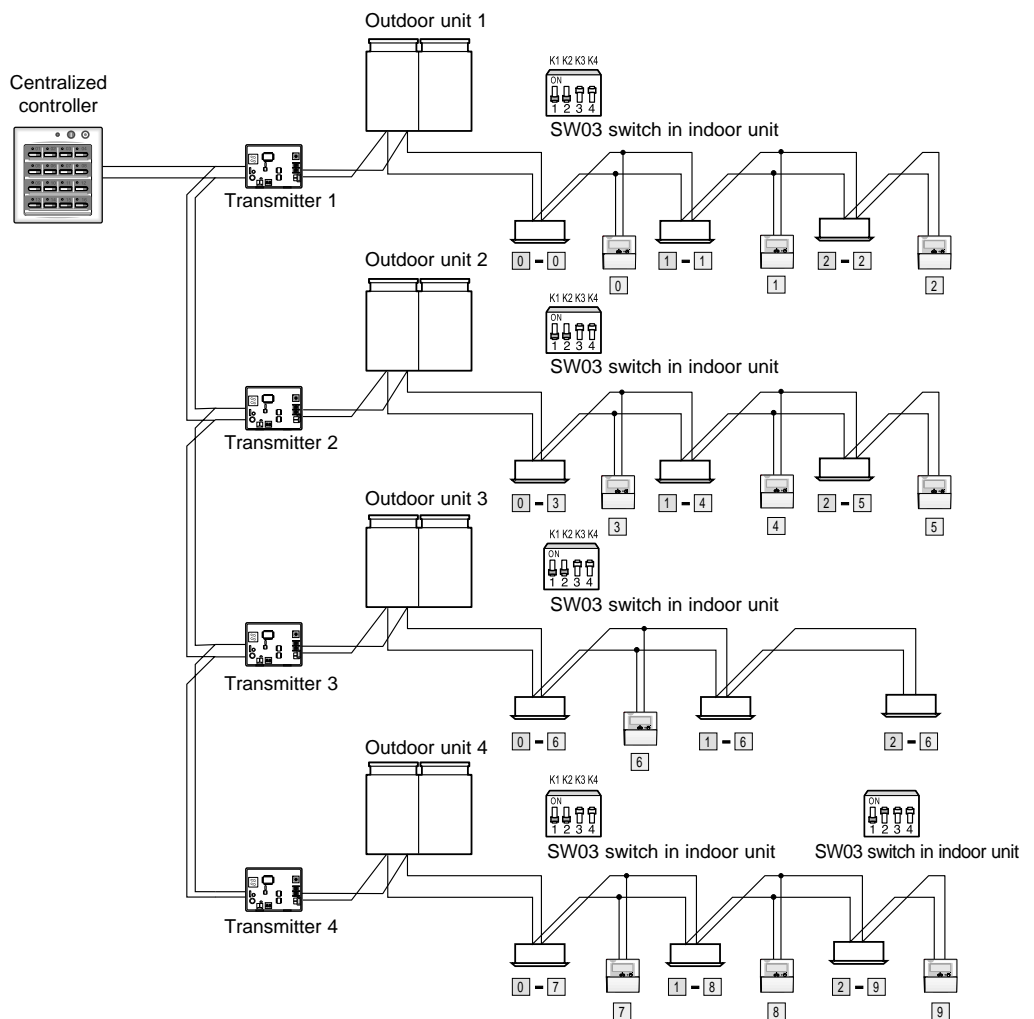



## 4. Installation

### Level of centralized controller

- ◆ Adjust the DIP switch on the centralized controller PCB, if necessary. Refer to the table below.

Switch No.	1	2	3	4	Meaning
Level 0	OFF	OFF	OFF	OFF	The air conditioner is operated by a controller adjusted the last among the wired and wireless remote controller, and centralized controller.
Level 1	ON	OFF	OFF	OFF	A user can use a wired/wireless controller only when the centralized controller is powered on.
Level 2	OFF	ON	OFF	OFF	The air conditioner can be operated by the centralized controller only.

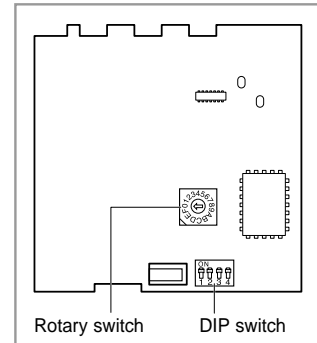







- ◆ If there is installed the wired remote controller together, refer to the table below.

Wired remote controller \ Centralized controller	Master Mode (No.4 DIP Switch "OFF")	Slave Mode (No.4 DIP Switch "ON")
	Centralized controller	The wired remote controller has priority to the centralized controller.
Level 0	The air conditioner is operated by the controller adjusted the last between the wired remote controller and the centralized controller.(The wireless remote controller cannot be used.)	The air conditioner is operated by a controller adjusted the last among the wired and wireless remote controller and the centralized controller.
Level 1	A user can use a wired controller only when the centralized controller is powered on.(The wireless remote controller cannot be used.)	A user can use a wired/wireless controller only when the centralized controller is powered on.
Level 2	The air conditioner can be operated by the centralized controller only.	The air conditioner can be operated by the centralized controller only.

## 4-4. Function controller

### (1) Accessories

Function controller (1)	Cable-tie(2)	Cable clamp (6)	M4x16 Tapped screw (7)	Owner's instructions(1)	Installation manual (1)
					

### (2) Installation

- 1) Disassemble the function controller by using a groove on its top.
- 2) Secure the rear cover of the function controller on the wall with two screws.
- 3) Connect the C1 and C2 terminals in the function controller to the same terminals in the centralized controller.
- 4) Reassemble the function controller.

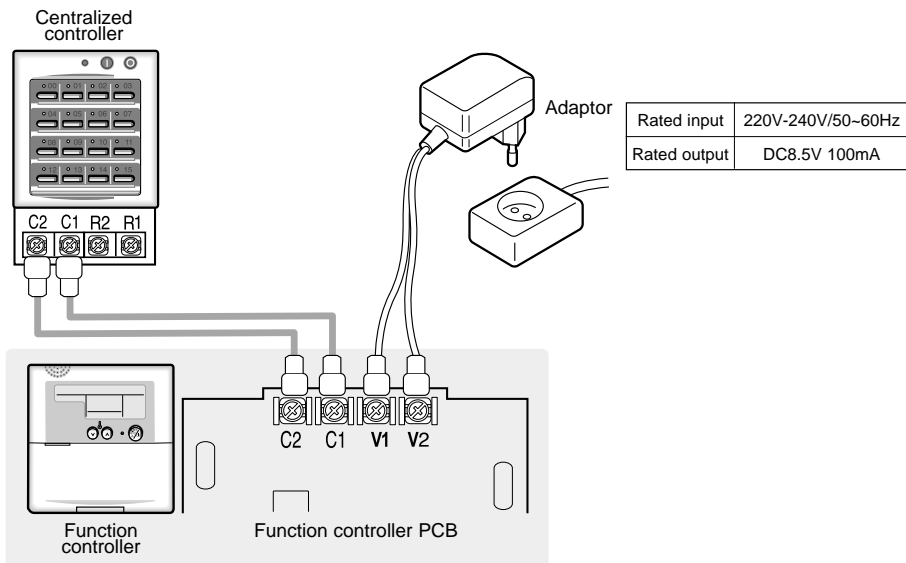
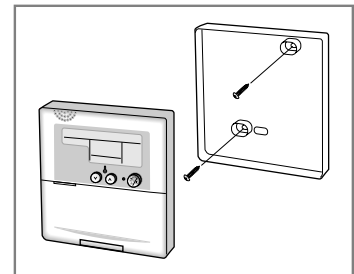

- ◆ You must align the same terminal when connecting cables. If the cables are connected improperly, the function controller will not work.
- ◆ The adaptor is not supplied with the function controller. Keep the polarity below when connecting the adaptor.
  - V1 : DC +12V, V2 : DC Ground



## 4. Installation





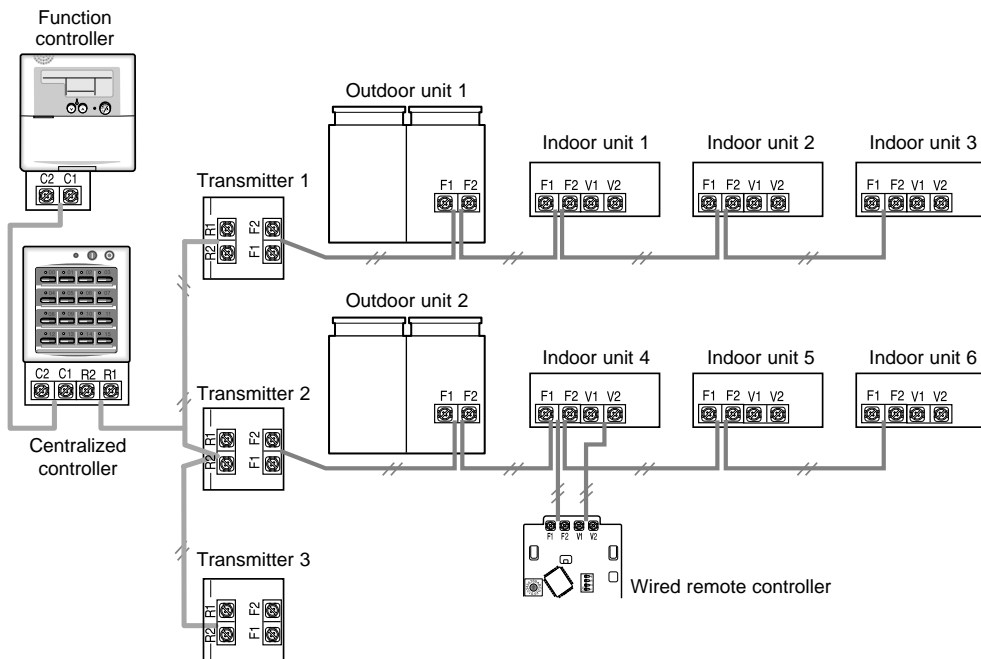

### (3) Wiring diagram

- ◆ Install the transmitter, another optional accessory, in the outdoor unit which will be controlled by the centralized controller, then connect the function controller and the centralized controller to the transmitter.
- ◆ Each outdoor unit connected to the same centralized controller must have its own transmitter.
- ◆ Distance between the centralized controller and the last transmitter should be 1000 meters or less.



## 4-5. Receiver & display unit - Concealed type

### (1) Accessories

Receiver & Display Unit (1) 	STS 2S-2x10 Tapped Screw (4) 	2S-4x12 Tapped Screw (2) 	Owner's instructions(1) 	Installation manual(1) 	Wire kit (Length:10m) 
--	---	---	--	--	--

### (2) Installation

- 1) Remove the receiver & display unit cover by using the tab on its bottom.
- 2) Open the receiver & display unit.
- 3) Connect the end of the connector wire to the receiver & display unit and connect the other end of the wire to the MAIN PCB (CN91) as shown in figure.

**\*Caution\*** ◆ Do NOT keep the receiver & display unit cable with a 220V cable because the remote controller cables have low voltage.

- 4) Secure the receiver & display unit on the wall with two screws.
- 5) Reassemble the receiver & display unit cover.

- \*Caution\*** ◆ The receiver & display unit must be installed by an installation specialist.
- ◆ Before installing the receiver & display unit, ensure that you have turned off the main power.
- ◆ All receiver & display unit cables should be installed according to the national wiring rules and you must install it in the wall not to be touched by users.

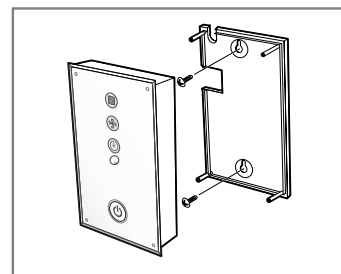
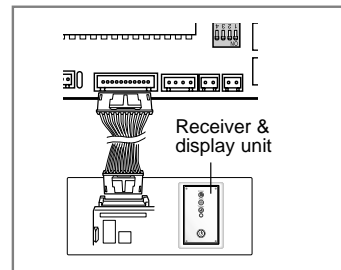









# 4. Installation

## 4-6. Receiver & display unit - Standard type

### (1) Accessories

<p>Function controller (1)</p> 	<p>Cable-Tie(2)</p> 	<p>Cable Clamp (6)</p> 	<p>M4x16 Tapped Screw (7)</p> 	<p>Owner's instructions(1)</p> 	<p>Installation manual (1)</p> 	<p>Wire kit (Length:10m)</p> 
--	---	--	---	--	---	--

### (2) Installation

- 1) Remove the receiver & display unit cover by using the tab on its bottom.
- 2) Open the receiver & display unit.
- 3) Connect the end of the connector wire to the receiver & display unit and connect the other end of the wire to the MAIN PCB (CN91) as shown in figure.

**\*Caution\*** ◆ Do NOT keep the receiver & display unit cable with a 220V cable because the remote controller cables have low voltage.

- 4) Close the receiver & display unit.
- 5) Secure the receiver & display unit on the wall with two screws.
- 6) Reassemble the receiver & display unit cover.

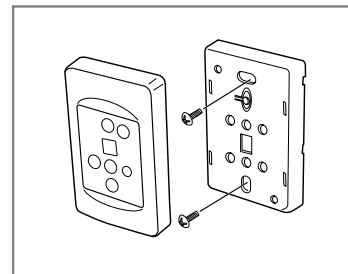
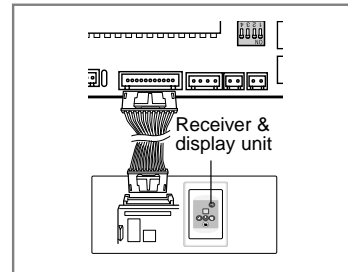

- \*Caution\*** ◆ The receiver & display unit must be installed by an installation specialist.
- ◆ Before installing the receiver & display unit, ensure that you have turned off the main power.
- ◆ All receiver & display unit cable should be installed according to the national wiring rules and you must install it in the wall not to be touched by users.

## 4-7. Transmitter

### (1) Accessories

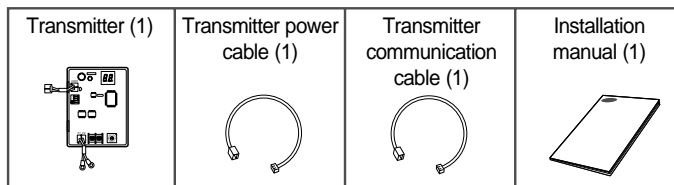

### (2) Installation

- ◆ Attach the transmitter to the left side of the electrical component box in outdoor unit, then connect the power and communication cable between the transmitter and the outdoor; refer to the figure below.
- ◆ If you install a transmitter to an outdoor unit, every indoor unit which is connected to an outdoor unit can be controlled simultaneously.
- ◆ Each outdoor unit connected to the same centralized controller has its own transmitter.

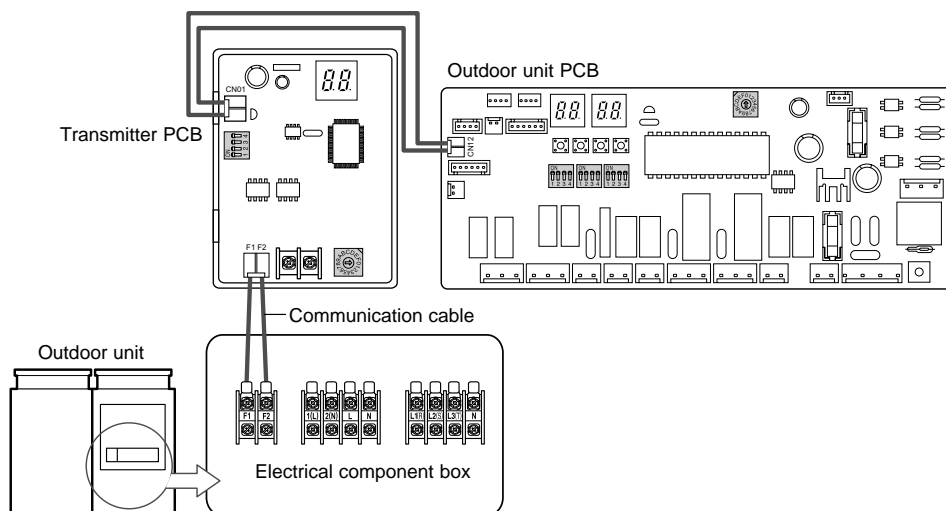

- ◆ Distance between the centralized controller and the last transmitter should be 1000 meters or less.



# 4. Installation

## (3) Wiring diagram

- ◆ Each outdoor unit connected to the same centralized controller has its own transmitter.
- ◆ Distance between the centralized controller and the last transmitter should be 1000 meters or less.

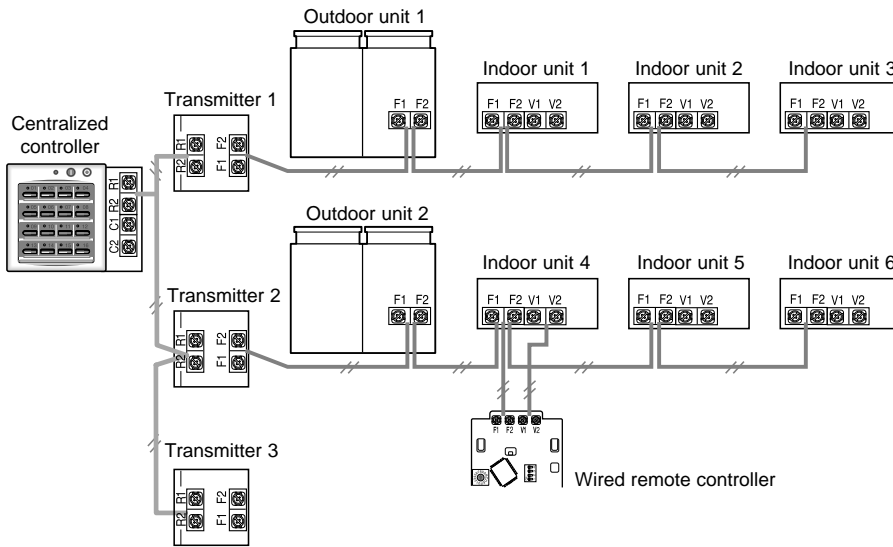

## (4) Transmitter installation

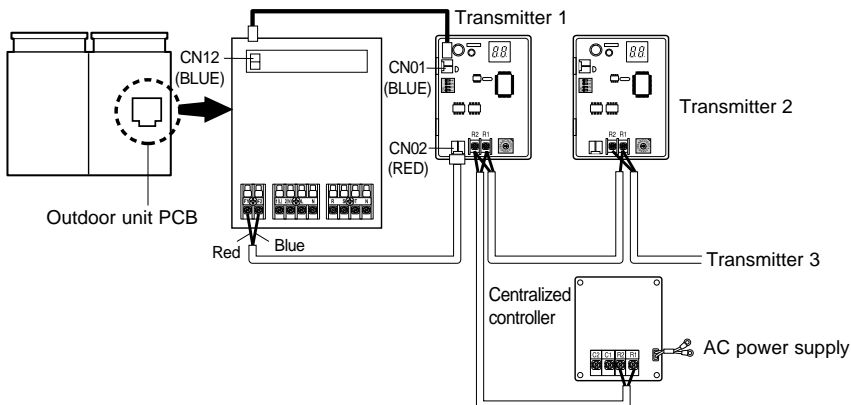

## (5) Assigning address

- ◆ Turn the arrow of rotary switch on the transmitter to appropriate position. Transmitters controlled with the same centralized controller must have different addresses.

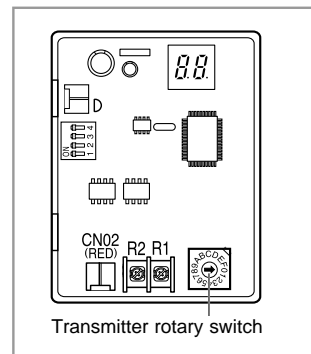



# 5. Assigning address

## 5-1. Indoor unit

- 1) Before installing the indoor unit, assign an address to the indoor unit according to the air conditioning system plan.
- 2) The address of the indoor unit is assigned by adjusting MAIN(SW02) and RMC(SW01) rotary switches.

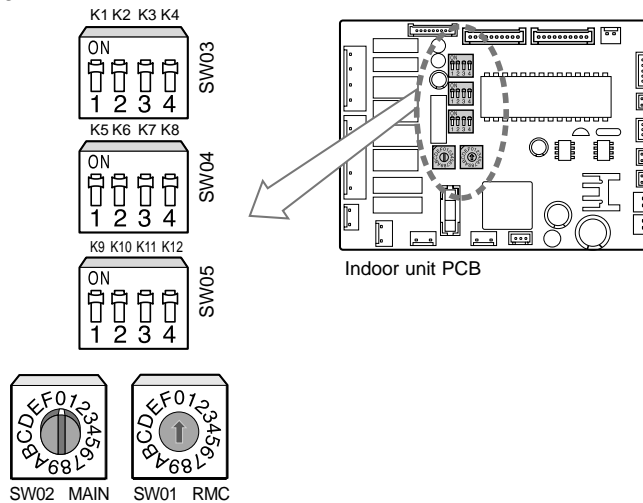

- 3) The MAIN address is for communication between the indoor unit and the outdoor unit. Therefore, you must set it to operate the air conditioner properly.
- 4) It is required to set the RMC address if you install the wired remote controller and/or the centralized controller.
- 5) If you install optional accessories such as the wired remote controller, centralized controller, etc. see an appropriate installation manual.
- 6) If an optional accessory is not installed, you do not have to set the RMC address. However, adjust K1 and K2 switches of the SW03 DIP switch to "ON" position in this case.
- 7) Set the MAIN address by adjusting the rotary switch(SW02) from 0 to F. Each indoor unit connected to the same outdoor unit must have different address.

i. e. If an indoor unit does not have an optional accessory and its MAIN address is "4"

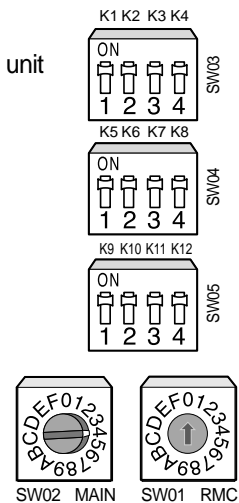



# 5. Assigning address

## 5-2. Outdoor unit

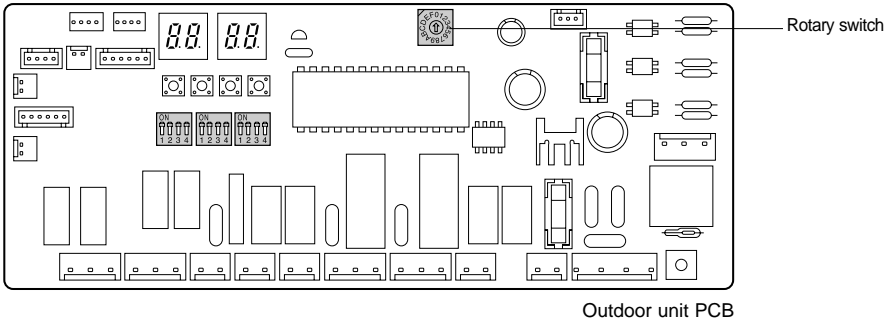

You should display that how many indoor units are connected to the outdoor unit. Refer to the table below, then turn the arrow to appropriate position.

Switch No.	Number of indoor unit(s)	Switch No.	Number of indoor unit(s)
1	One	9	Nine
2	Two	A	Ten
3	Three	B	Eleven
4	Four	C	Twelve
5	Five	D	Thirteen
6	Six	E	Fourteen
7	Seven	F	Fifteen
8	Eight	-	-

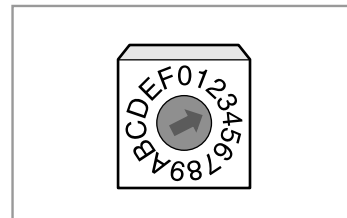





# 6. Indoor unit PCB option code

## 6-1. PCB option code input method (example : 021E31142285)

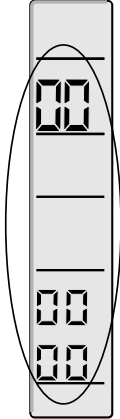

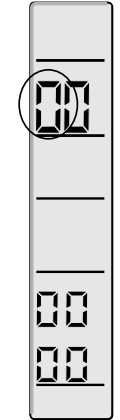

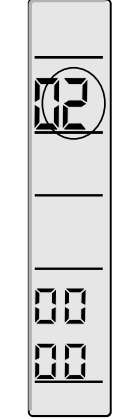

Be sure to input the option code suitable for the indoor unit by use of wireless remote controller after replacing the PCB of indoor unit.





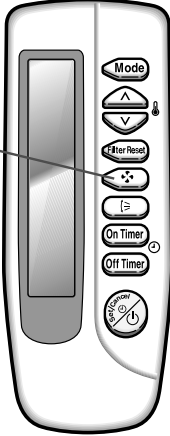

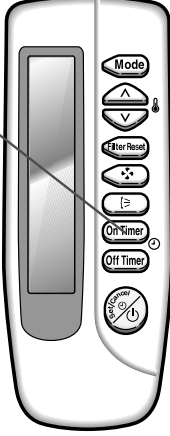
Follow to do the following 15 steps sequentially.

Operation method	Applicable button	Indicating state
<p><b>* Step 1</b></p> <p><u>Method)</u>            ① Remove the battery of remote controller.            ② Push the temperature adjustment button simultaneously.            ③ Insert the battery.</p> <p><u>Result)</u>            When the display of remote controller is indicated as shown in the right, then go to the step 2.</p>		
<p><b>* Step 2</b></p> <p><u>Method)</u>            If the first digit of remote controller shows "0", go to the step 3.            * If it shows 1, press the operation selection button one time to change it into 0 and then go to step 3.</p>		
<p><b>* Step 3</b></p> <p><u>Method)</u>            Input the second digit of option code by pressing the temperature adjustment button (up).            example) 0<u>2</u>1E31142285</p> <p><u>Result)</u>            If 2 is displayed, go to the step 4 (whenever pressing the button, 1~9, A,B,C,D,E,F are lit in order.)</p>		

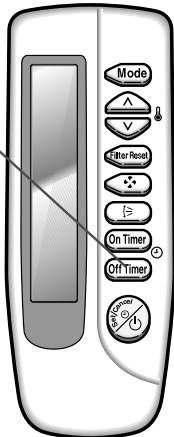







# 6. Indoor unit PCB option code



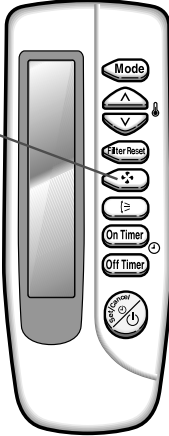

Operation method	Applicable button	Indicating state
<p><b>* Step 4</b></p> <p><u>Method)</u> Input the third digit of option code by pressing the temperature adjustment button (down). example) 021E31142285</p> <p><u>Result)</u> If 1 is displayed, go to the step 5.</p>		
<p><b>* Step 5</b></p> <p><u>Method)</u> Input the fourth digit of option code by pressing the fan speed adjustment button.</p> <p>example) 021E31142285</p> <p><u>Result)</u> If E displays, go to step 6.</p>		
<p><b>* Step 6</b></p> <p><u>Method)</u> Input the fifth digit of option code by pressing the On timer button.</p> <p>example) 021E31142285</p> <p><u>Result)</u> If 3 displays, go to step 7.</p>		

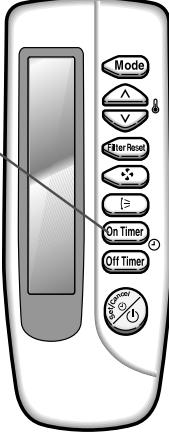
Operation method	Applicable button	Indicating state
<p><b>* Step 7</b></p> <p><u>Method)</u> Input the sixth digit by pressing the Off timer button. example) 021E31142285</p> <p><u>Result)</u> If 1 displays, go to step 8.</p>		
<p><b>* Step 8</b></p> <p><u>Method)</u> After completion up to step 7, pressing mode button.</p> <p>① 1 ~ 7 steps are saved internally. ② If the first number is 1 at the time, it is correct. So go to step 9. * If wanting to see the screen of 2 ~7 steps, press the mode button to make the first digit 0.</p>		
<p><b>* Step 9</b></p> <p><u>Method)</u> Input the eighth digit by pressing the temperature adjustment button (up). example) 021E31142285</p> <p><u>Result)</u> If 4 displays, go to step 10.</p>		

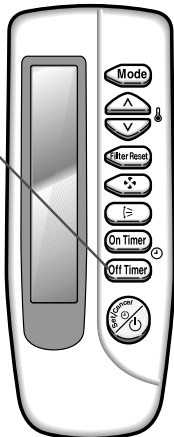

# 6. Indoor unit PCB option code

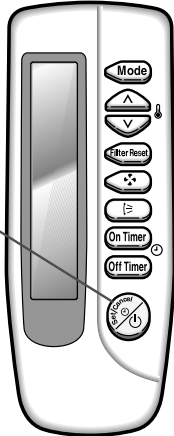
Operation method	Applicable button	Indicating state
<p><b>* Step 10</b></p> <p><u>Method)</u> Input the ninth digit by pressing the temperature adjustment button (down). example) 021E3114<u>2</u>285</p> <p><u>Result)</u> If 2 displays, go to step 11.</p>		
<p><b>* Step 11</b></p> <p><u>Method)</u> Input the tenth digit by pressing fan speed adjustment button. example) 021E3114<u>2</u>285</p> <p><u>Result)</u> If 2 displays, go to step 12.</p>		
<p><b>* Step 12</b></p> <p><u>Method)</u> Input the 11st digit by pressing the On timer button. example) 021E311422<u>8</u>5</p> <p><u>Result)</u> If 8 displays, go to step 13.</p>		

Operation method	Applicable button	Indicating state
<p>* Step 13</p> <p><u>Method)</u> Input the 12th digit by pressing the Off timer button. (example) 021E3114228<u>5</u></p> <p><u>Result)</u> If 5 displays, go to step 14.</p>		
<p>* Step 14</p> <p><u>Method)</u> Turn the remote controller toward the indoor unit and press the On/Off button, and if the "Ting" or "Tarirring" sounds, the input of option is completed.</p> <p>* If error displays, solve the problem with reference to the right side.</p>		<p>■ Error</p> <p>① If the Operation, Timer and Fan indicator is flickering, the wrong option code is input. Put off the power of indoor unit and turn it on again and then input the option code again. If the same error occurs, it is the EEPROM is defective or not inserted. Replace the PCB.</p> <p>② If all of Operation, Timer, Fan and Filter indicator are flickering along with the "Titiring" sound, there is option code already input which are different from the current ones. Check the option code and press the button again if correct. Option code will be input. (Check the option code correctly. At the time, if the same error continues to occur, the option code is out of input range. Check the option code again and repeat the step 1-14.</p>
<p>* Step 15</p> <p><u>Method)</u> If the steps 1 to 14 are completed, remove the battery and insert it again to return to the original display of remote controller. (Operation mode/SET TEMP./fan speed displays.)</p>	 <p>rear side</p>	



## 6. Indoor unit PCB option code

### 6-2. Option code

Type	Model	SEG1	SEG2	SEG3	SEG4	SEG5	SEG6	SEG7	SEG8	SEG9	SEG10	SEG11	SEG12	Remark
1-way Cassette type	AVMKC020E(C)A0	0	0	0	0	0	0	1	1	2	0	C	8	
	AVMKC026EA0	0	0	0	0	0	0	1	4	2	2	1	D	
	AVMKC032CA0	0	0	0	0	0	0	1	4	2	2	1	D	
	AVMKC035EA0	0	0	0	0	0	0	1	6	2	3	4	0	
	AVMKC040CA0	0	0	0	0	0	0	1	6	2	3	4	0	
	AVMKH020E(C)A0	0	0	5	6	0	0	1	1	2	0	C	8	
	AVMKH026EA0	0	0	5	6	0	0	1	4	2	2	1	D	
	AVMKH032CA0	0	0	5	6	0	0	1	4	2	2	1	D	
	AVMKH035EA0	0	0	5	6	0	0	1	6	2	3	4	0	
	AVMKH040CA0	0	0	5	6	0	0	1	6	2	3	4	0	
4-way Cassette type	ABM1800B1	0	4	0	0	0	0	1	9	2	0	0	0	
	ABM2400B1	0	4	0	0	0	0	1	C	2	0	0	0	
	AVMCC052E(C)A0	0	4	0	0	0	0	1	9	0	0	0	0	
	AVMCC070EA0	0	4	0	0	0	0	1	C	0	0	0	0	
	AVMCC072CA0	0	4	0	0	0	0	1	C	0	0	0	0	
	AVMCC105E(C)A0													
	AVMCH052E(C)A0	0	4	5	2	0	0	1	9	0	0	0	0	
	AVMCH070EA0	0	4	5	2	0	0	1	C	0	0	0	0	
	AVMCH072CA0	0	4	5	2	0	0	1	C	0	0	0	0	
AVMCH105E(C)A0	0	4	5	A	0	0	1	0	0	0	0	0		
Duct type (Low silhouette)	ADM1800B1	0	0	0	0	0	0	1	9	2	0	0	0	
	ADM2400B1	0	0	0	0	0	0	1	C	2	0	0	0	
	AVMDC052E(C)A0	0	0	0	0	0	0	1	9	0	0	0	0	
	AVMDC070EA0	0	0	0	0	0	0	1	C	0	0	0	0	
	AVMDC072CA0	0	0	0	0	0	0	1	C	0	0	0	0	
	AVMDH052E(C)A0	0	1	5	2	0	0	1	9	0	0	0	0	
	AVMDH070EA0	0	1	5	2	0	0	1	C	0	0	0	0	
AVMDH072CA0	0	1	5	2	0	0	1	C	0	0	0	0		
Duct type (Built-in)	AVMBC020E(C)A0													
	AVMBC026EA0													
	AVMBC032CA0													
	AVMBC035EA0													
	AVMBC040CA0													
	AVMBC052E(C)A0													
	AVMBC070EA0													
	AVMBC072CA0													
	AVMBH020E(C)A0	0	1	5	2	0	0	1	1	0	0	0	0	
	AVMBH026EA0	0	1	5	2	0	0	1	4	0	0	0	0	
	AVMBH032CA0	0	1	5	2	0	0	1	4	0	0	0	0	
	AVMBH035EA0	0	1	5	2	0	0	1	6	0	0	0	0	
	AVMBH040CA0	0	1	5	2	0	0	1	6	0	0	0	0	
	AVMBH052E(C)A0	0	1	5	2	0	0	1	9	0	0	0	0	
	AVMBH070EA0	0	1	5	2	0	0	1	C	0	0	0	0	
AVMBH072CA0	0	1	5	2	0	0	1	C	0	0	0	0		



Type	Model	SEG1	SEG2	SEG3	SEG4	SEG5	SEG6	SEG7	SEG8	SEG9	SEG10	SEG11	SEG12	Remark
Duct type (High pressure)	AVMHC105E(C)A0													
	AVMHC128E(C)A0													
	AVMHH105E(C)A0	0	1	5	A	0	0	1	0	0	0	0	0	
	AVMHH128E(C)A0	0	1	5	A	0	0	1	2	0	0	0	0	
Wall-mounted type	AVMWC020E(C)A0													
	AVMWC026EA0													
	AVMWC032CA0													
	AVMWC035EA0													
	AVMWC040CA0													
	AVMWC052E(C)A0													
	AVMWC070EA0													
	AVMWC072CA0													
	AVMWH020E(C)A0	0	8	5	6	0	0	1	1	2	0	C	8	
	AVMWH026EA0	0	8	5	6	0	0	1	4	2	2	1	D	
	AVMWH032CA0	0	8	5	6	0	0	1	4	2	2	1	D	
AVMWH035EA0	0	8	5	6	0	0	1	6	2	3	4	0		
AVMWH040CA0	0	8	5	6	0	0	1	6	2	3	4	0		
AVMWH052E(C)A0	0	8	5	6	0	0								
AVMWH070EA0	0	8	5	6	0	0								
AVMWH072CA0	0	8	5	6	0	0								
Floor standing type	AVMPC058E(C)A0													
	AVMPC070EA0													
	AVMPC072CA0													
	AVMPC082E(D)A0													
	AVMPC083CA0													
	AVMPH058E(C)A0													
	AVMPH070EA0													
	AVMPH072CA0													
	AVMPH082EA0													
	AVMPH083CA0													
Ceiling type	AVMFC052E(C)A0													
	AVMFC070EA0													
	AVMFC072CA0													
	AVMFH052E(C)A0													
	AVMFH070EA0													
	AVMFH072CA0													

## 7. S-Net

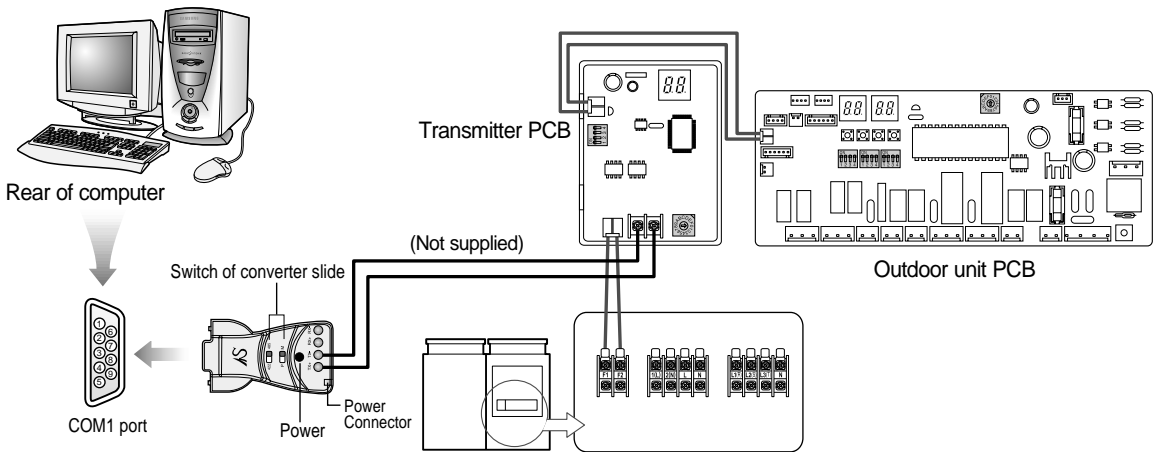

- 1) Download S-NET program to your PC, then execute Setup.exe to install the program.
- 2) If the installation is completed successfully, connect RS-485 converter to COM1 or COM2 port on your computer.
- 3) Connect R1 and R2 terminals on the transmitter PCB to TX+ and TX- on the RS-485 converter.
- 4) Double-click **DVMSNET 2.0** icon to open the program after completing the installation.

## 8. Integrating power distribution system



## 9. Building management system



# III

## Indoor unit

<b>1</b>	<b>Features</b>		<b>6</b>	<b>Refrigerant system diagram (Cooling only &amp; heat pump)</b>	
	1-1. 1-way cassette type .....	2		6-1. Refrigerant system diagram .....	73
	1-2. 4-way cassette type .....	4		6-2. Main parts status .....	73
	1-3. Duct type .....	6	<b>7</b>	<b>Electric circuit diagram</b>	
	1-4. Wall-mounted type .....	8		7-1. 1-way cassette type .....	74
	1-5. Floor standing type .....	10		7-2. 4-way cassette type .....	76
	1-6. Ceiling type .....	12		7-3. Duct type .....	78
<b>2</b>	<b>Specification</b>			7-4. Wall-mounted type .....	80
	2-1. 1-way cassette type .....	14		7-5. Floor standing type .....	82
	2-2. 4-way cassette type .....	16		7-6. Ceiling type .....	84
	2-3. Duct type (Low silhouette) .....	18	<b>8</b>	<b>Noise level</b>	
	2-4. Duct type (Built-in) .....	20		8-1. Overall .....	86
	2-5. Duct type (High pressure) .....	24		8-2. Octave band level .....	87
	2-6. Wall-mounted type .....	26	<b>9</b>	<b>Velocity of air flow &amp; temperature distribution</b>	
	2-7. Floor standing type .....	30		9-1. 1-way cassette type .....	102
	2-8. Ceiling type .....	32		9-2. 4-way cassette type .....	103
<b>3</b>	<b>Functional parts and safety devices</b>			9-3. Wall-mounted type .....	105
	3-1. 1-way cassette type .....	34		9-4. Ceiling type .....	107
	3-2. 4-way cassette type .....	34	<b>10</b>	<b>Fan specifications</b>	
	3-3. Duct type (Low silhouette) .....	35		10-1. Duct type(Low silhouette) .....	108
	3-4. Duct type (Built-in) .....	36		10-2. Duct type(Built-in) .....	109
	3-5. Duct type (High pressure) .....	36		10-3. Duct type(High pressure) .....	110
	3-6. Wall-mounted type .....	37	<b>11</b>	<b>Panel</b>	
	3-7. Floor standing type .....	38		11-1. 1-way cassette type .....	111
	3-8. Ceiling type .....	38		11-2. 4-way cassette type .....	112
<b>4</b>	<b>Capacity table</b>		<b>12</b>	<b>Electronic expansion valve kit</b>	
	4-1. 50Hz .....	39		12-1. Design .....	113
	4-2. 60Hz .....	45		12-2. Status depending on the combination .....	113
<b>5</b>	<b>Dimension</b>		<b>13</b>	<b>Options</b>	
	5-1. 1-way cassette type .....	51			
	5-2. 4-way cassette type .....	52			
	5-3. Duct type (Low silhouette) .....	54			
	5-4. Duct type (Built-in) .....	55			
	5-5. Duct type (High pressure) .....	57			
	5-6. Wall-mounted type .....	58			
	5-7. Floor standing type .....	60			
	5-8. Ceiling type .....	61			
	5-9. Wireless remote controller / Receiver .....	62			
	5-10. Wired remote controller .....	70			
	5-11. Option controller .....	72			



# 1. Features

## 1-1. 1-Way cassette type



### (1) Efficient cooling & stylish design

This type sends cool air from the ceiling to one direction; thus immediate cooling. Even more, the stylish design blends with any interior design.

### (2) Space saving

Installation in the ceiling translates to more available space in the room.

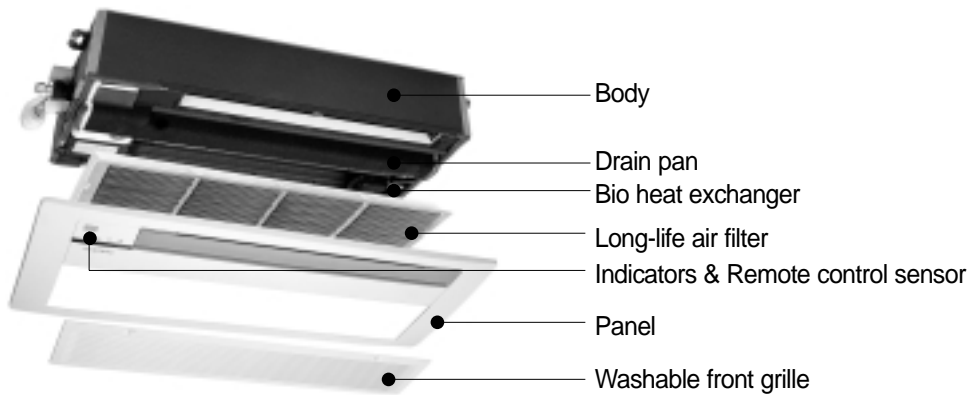

### (3) Features of the 1-way cassette type

#### 1) Long-life air filter

The long-life filter requires no maintenance for up to 2,000 hours.



#### 2) Bio heat exchanger & air filter

Samsung's own heat exchanger and air filter prevent any penetration of fungi or bacteria into the system.



#### 3) Double-insulated cabinet

Dual insulation of the the steel cabinet inhibits rust caused by dew.

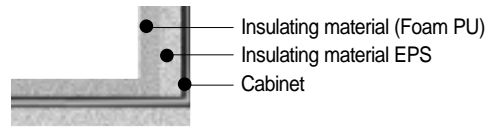

#### 4) Detachable front grille

Trouble-free cleaning of detachable front grill.



#### 5) Indicator for filter cleaning

A filter cleaning indicator is displayed both on the indoor unit and the wired remote controller.



#### 6) Compact design

This unit does not require much space and can be installed into a shallow ceiling.

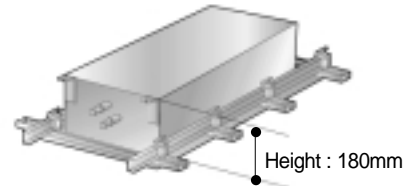

#### 7) Lift-up drain pump

The drain pump can lift condensed water up to 750mm above the drain port.

This allows more flexibility in routing the tube through the ceiling space.



Model	AVMKC020C(E)A0 AVMKH020C(E)A0	AVMKC026EA0 AVMKH026EA0	AVMKC032CA0 AVMKH032CA0	AVMKC035EA0 AVMKH035EA0	AVMKC040CA0 AVMKH040CA0
Cooling(kW)	2.0	2.6	3.2	3.5	4.0
Heating(kW)	2.2	2.9	3.5	3.8	4.3



# 1. Features

## 1-2. 4-Way cassette type



### (1) Powerful functions

The 4-way cassette type air conditioner has all the features of the 1-way cassette type; compact design, long-life air filter, bio heat exchanger, lift-up drain pump, etc.

### (2) Higher & broader cooling

This type is used in applications where a high ceiling and open space is present, resulting in equal & wide-range cooling.

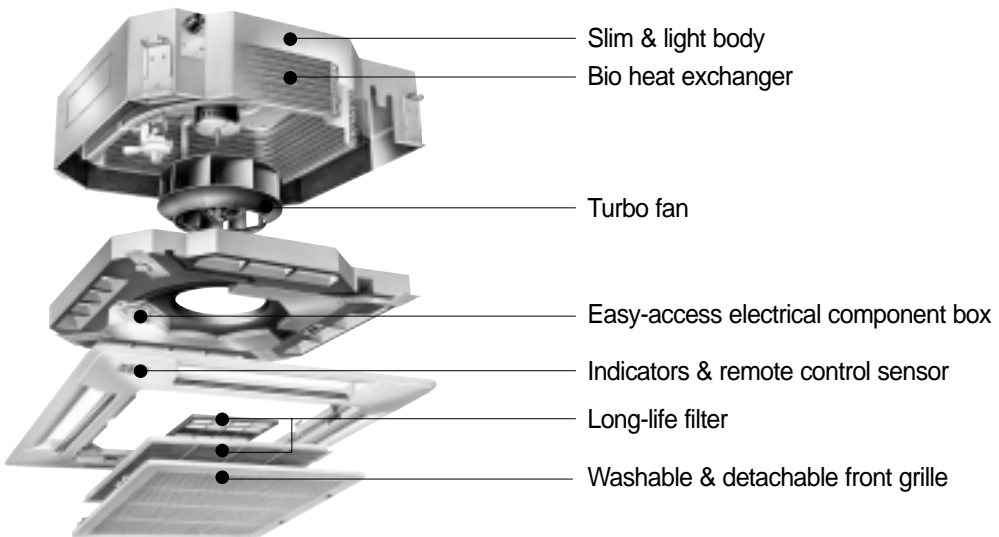



### (3) Features of 4-way cassette type

#### 1) Fan speed adjustment

Fan speed can be adjusted according to the ceiling height.  
\* Max. installation ceiling height is 3.5 meters.

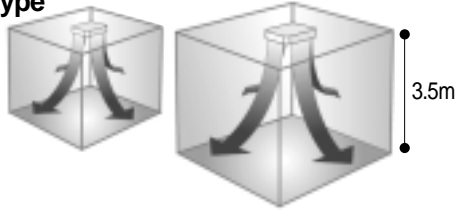

Item	Ceiling height
H	2.7~3.5m
L	2.7m

#### 2) Versatile airflow

The direction of airflow can be selected to meet installation or room specifications.

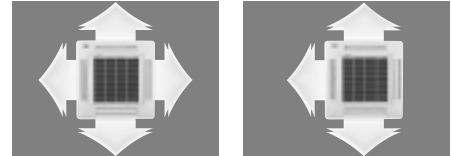

4 Way pattern

3 Way pattern

#### 3) Sub duct

A sub duct connected to the side of the cassette air conditioner allows the simultaneous cooling / heating of two separate rooms. (Must use an additional ventilation fan)

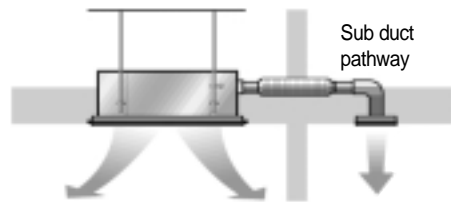

#### 4) Efficient cooling

Cool air is distributed in all directions from the ceiling, resulting in equal & fast cooling.

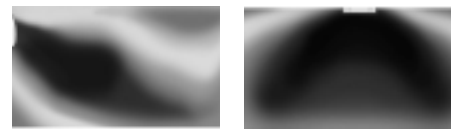

Conventional cooling system

Ceiling type cooling system

#### 5) Compact design

Little space is required for installation into a shallow ceiling.

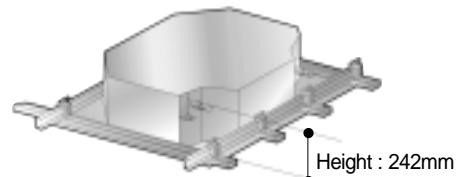

Height : 242mm

#### 6) High performance drain pump

The drain pump can lift condensed water up to 750mm above the drain port, thus allowing more flexibility in piping the tube through the ceiling space.



max. 750mm

Model	AVMCC052C(E)A0 AVMCH052C(E)A0	AVMCC070EA0 AVMCH070EA0	AVMCC072CA0 AVMCH072CA0	AVMCC105C(E)A0 AVMCH105C(E)A0
Cooling(kW)	5.2	7.0	7.2	10.5
Heating(kW)	5.6	7.6	7.6	11.4



# 1. Features

## 1-3. Duct type

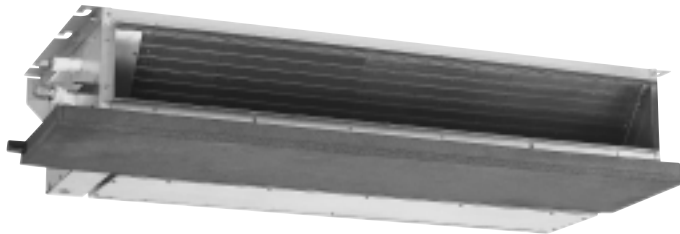

### (1) Economic installation

Several diffusers branch off from an indoor unit, adjusting the room temperature, which makes many rooms to be air conditioned with only one indoor unit.



Looks of installed Duct (Built-in type)

### (2) High external static pressure

Adjustable external static pressure allows ducts from the unit to be used more extensively. This facilitates convenient positioning of the air-outlet vents in optimum locations.

Item	External static pressure	Fan speed
Normal	10mmAq	Low ▶ Mid ▶ High
High	20mmAq	Mid ▶ High ▶ Max

### (3) Features of Duct type

#### 1) Application methods

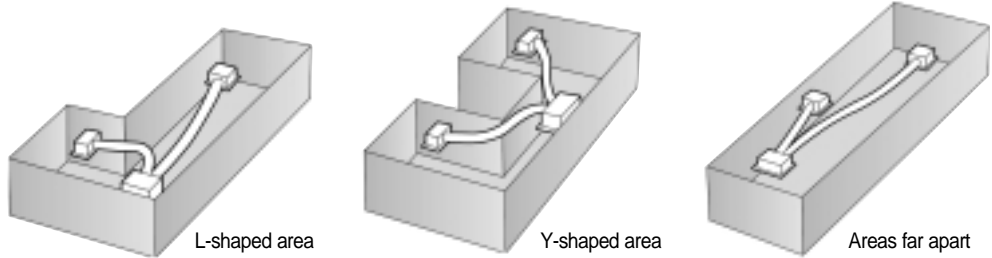

#### 2) Way of air intake & Inserting air filter

Air intake can be positioned either at the back or below the unit. Similarly, the air filter can be inserted either from the back or from the bottom of the unit.

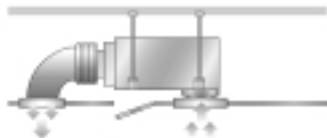

Built-in duct type

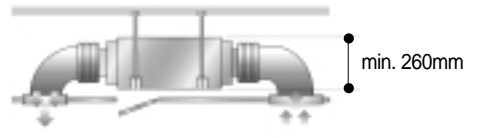

High pressure / Low silhouette duct type

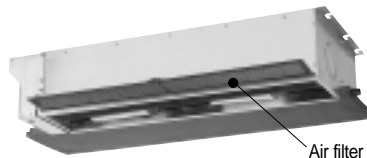

Air intake from below

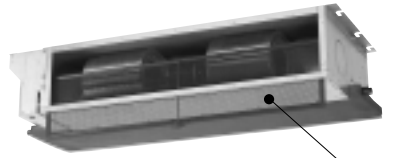

Air intake from the back

Model	Built-in							
	AVMBC020C(E)A0 AVMBH020C(E)A0	AVMBC026EA0 AVMBH026EA0	AVMBC032CA0 AVMBH032CA0	AVMBC035EA0 AVMBH035EA0	AVMBC040CA0 AVMBH040CA0	AVMBC052C(E)A0 AVMBH052C(E)A0	AVMBC070EA0 AVMBH070EA0	AVMBC072CA0 AVMBH072CA0
Cooling(kW)	2.0	2.6	3.2	3.5	4.0	5.2	7.0	7.2
Heating(kW)	2.2	2.9	3.5	3.8	4.3	5.6	7.6	7.6

Model	Low silhouette			High pressure	
	AVMDC052C(E)A0 AVMDH052C(E)A0	AVMDC070EA0 AVMDH070EA0	AVMDC072CA0 AVMDH072CA0	AVMHC105C(E)A0 AVMHH105C(E)A0	AVMHC128C(E)A0 AVMHH128C(E)A0
Cooling(kW)	5.2	7.0	7.2	10.5	12.8
Heating(kW)	5.6	7.6	7.6	11.4	13.8



# 1. Features

## 1-4. Wall-mounted type



### (1) BIO-components

Samsung air conditioners ensure cleaner cooling than any other air conditioner. The components of our air conditioners (including the filters) have been treated with our unique antibacterial formula, which prevent the proliferation of fungi and bacteria within the unit, helping to keep the unit clean, and to block odors from developing. This process also extends product life span. Breathe with ease and enjoy the cool refreshing air provided by Samsung air conditioners with Bio-components.

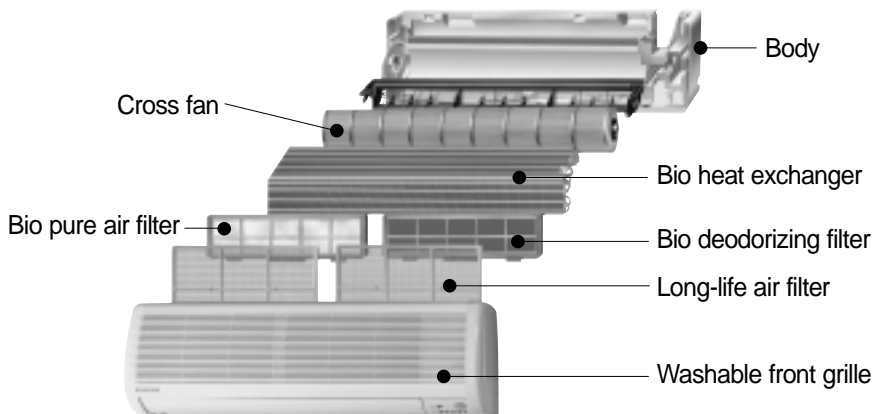

### (2) Features of wall-mounted type

#### 1) Bio air cleaning system

Samsung air conditioners are equipped with 3-state filters for clean, fresh air.

- ① The bio pre-filter is the unit's outermost filter, uniquely treated with antibacterial agents, catching most particles in the air such as dust.
- ② The bio pure air filter grabs smaller particles such as micro-organisms which may have escaped the bio pre-filter.
- ③ The bio deodorizing filter further cleans and deodorizes the air just before it enters the heat exchanger.

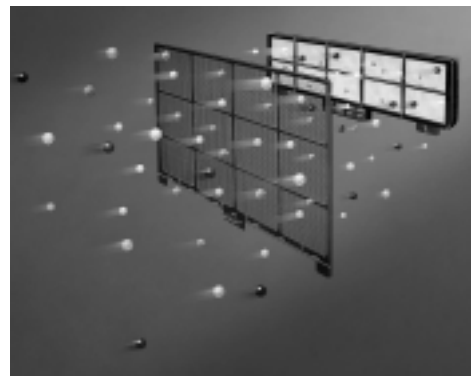

## 2) Look at how well these filters perform

### ① Hydrocarbon analysis

- Test: A deodorizing filter is installed within the duct and its efficiency is tested.(at a wind speed of 0.35m<sup>3</sup>/min.)
- Method: Measure the removal efficiency by installing a filter inside the duct, fixing the density of toluene gas and measuring its density at the exit point.-Tested by AFTL (U.S.A)

### ② Particle size vs. removal efficiency

- Test: When the size of dust is 5µm, the maximum removal efficiency is 75.6%. (at a wind speed of 1.42m<sup>3</sup>/min.)
- Method: The removal efficiency was tested by measuring the sizes of the particles removed and the amount of dust in the front and back of the filter with a laser particle counter.
- Tested by AFTL (U.S.A)

● AFTL(Air Filter Testing Laboratories, Inc.)

4632 Old laGrange Road, 1 Chestwood, KY 40014

Tel/Fax:(502) 222-5729

### ■ Bio deodorizing filter

Removal efficiency

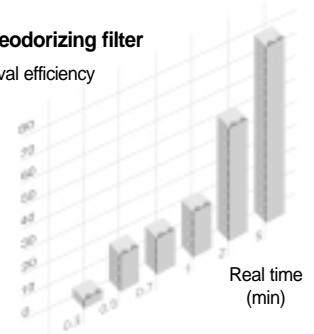

### ■ Bio pure filter

Removal efficiency

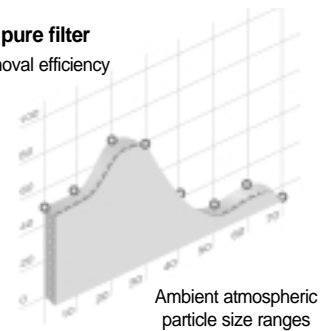

## 3) Specially designed for easy installation

Our new air conditioners are extremely compact and much lighter than previous models, making them extremely easy to handle and install. Additionally, with its stylish design, a Samsung air conditioner will be an attractive addition to any home or office.



Volume 28% Down

## 4) Easily detachable and washable front grille

It is easy to clean as the grille can be pulled apart and easy to replace as it just slides in.

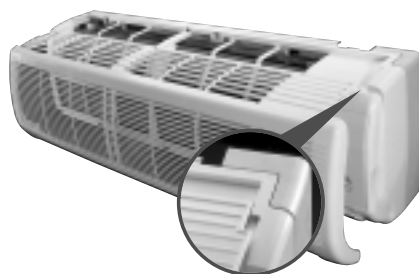

## 5) One-touch hanger plate

The main housing and the installation plate can be easily separated with a simple movement as shown in the diagram.



Model	AVMMWC020C(E)A0	AVMMWC026EA0	AVMMWC032CA0	AVMMWC035EA0	AVMMWC040CA0	AVMMWC052C(E)A0	AVMMWC070EA0	AVMMWC072CA0
	AVMMWH020C(E)A0	AVMMWH026EA0	AVMMWH032CA0	AVMMWH035EA0	AVMMWH040CA0	AVMMWH052C(E)A0	AVMMWH070EA0	AVMMWH072CA0
Cooling(kW)	2.0	2.6	3.2	3.5	4.0	5.2	7.0	7.2
Heating(kW)	2.2	2.9	3.5	3.8	4.3	5.6	7.6	7.6



# 1. Features

## 1-5. Floor standing type

### (1) Features of floor standing type

#### 1) The auto shutter increased clean lines

The auto shutter protects the air conditioner from dust even without a cover and the air conditioner goes well with any home.



#### 2) Using the control panel on the indoor unit

You can operate with indoor unit when you do not wish to or cannot operate the air conditioner with the remote control.

#### 3) Using the remote control

All functions of the air conditioner can be controlled with the remote control.

Automatic operating mode/cooling mode/dry mode/3way(Turbo, Long, Sleep timer)/fan mode/adjusting the air flow direction vertically/setting the on timer/setting the off timer.

#### 4) Flexibility of installation

This unit will sustain climate control in a large area. Suitable in commercial environments such as restaurants, shops, and offices to ensure the comfort of customers and staff.

These particularly stylish units, using only a small amount of floor space, will install in many places where conventional split systems will not fit.

The low-level pipe work connection makes this unit attractive in restaurants, offices or in the home. Available with a heating function or cooling only. Each model also has auto-louvers and a turbo function.

Model	AVMPC060C(E)A0 AVMPH060C(E)A0	AVMPC070EA0 AVMPH070EA0	AVMPC072CA0 AVMPH072CA0	AVMPC082EA0 AVMPH082EA0	AVMPC083CA0 AVMPH083CA0
Cooling(kW)	6.0	7.0	7.2	8.2	8.3
Heating(kW)	6.4	7.6	7.6	8.8	8.8

## 5) Design

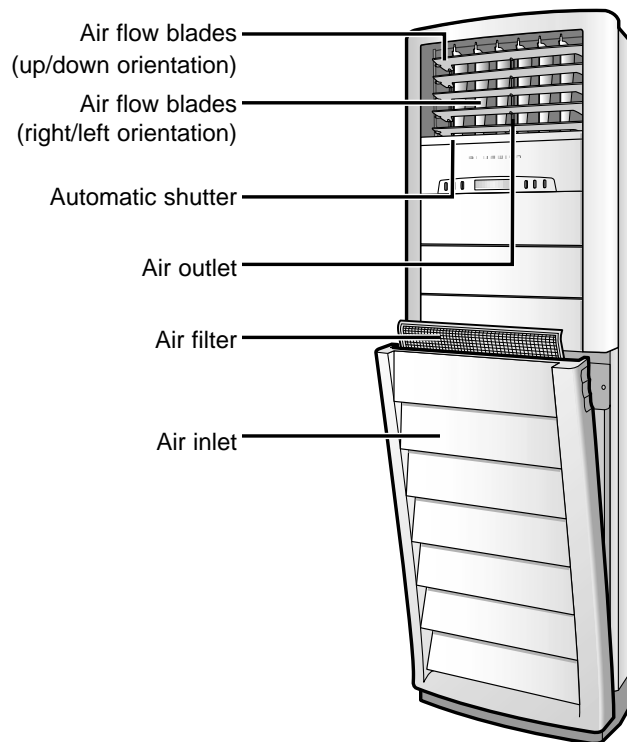

### ■ Control panel

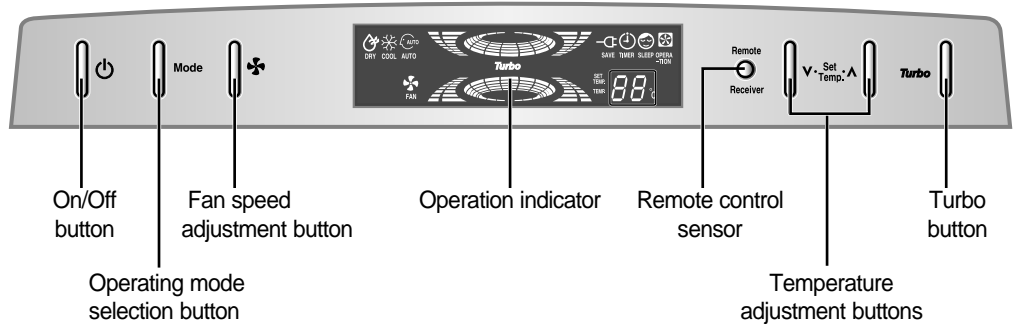



# 1. Features

## 1-6. Ceiling type



### (1) Convenient installation

The ceiling type air conditioner can be easily installed into a corner of the ceiling even if the ceiling is very narrow. This is especially useful when installation of an air conditioner in the center of the ceiling is impossible due to a structure such as a lighting fixture.

### (2) Bio tech for fresh air and advanced function

Antibiotic bio-components control the spreading of bacteria throughout the system.



Ceiling installation



Floor installation



### (3) Features of ceiling type

#### 1) Long life filter with antibacterial treatment

The detachable filter can be cleaned easily, thus controlling the propagation of fungi & bacteria.



#### 2) Drain water lift-up mechanism (Optional)

The "Drain water lift-up" mechanism offers more flexible installation.

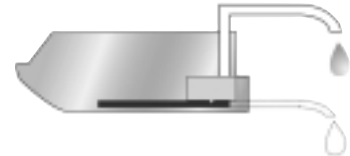

#### 3) Double auto swing

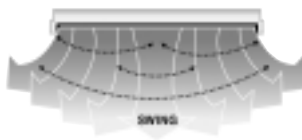

Right and left

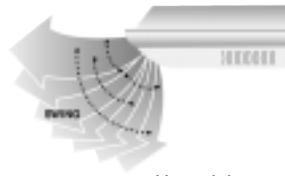

Up and down



Wide air flow

Model	AVMFC052C(E)A0 AVMFH052C(E)A0	AVMFC070EA0 AVMFH070EA0	AVMFC072CA0 AVMFH072CA0
Cooling(kW)	5.2	7.0	7.2
Heating(kW)	5.2	7.6	7.6



## 2. Specification

### 2-1. 1-way cassette type (1) 50Hz

Model				AVMKC020EA0	AVMKC026EA0	AVMKC035EA0	AVMKH020EA0	AVMKH026EA0	AVMKH035EA0
Power supply			ø, V, Hz	1, 220 - 240, 50					
Remark				Cooling only			Heat pump		
Performance	Capacity	Cooling * 1)	Btu/h	7000	9000	12000	7000	9000	12000
			kW	2.0	2.6	3.5	2.0	2.6	3.5
		Heating * 2)	Btu/h	-	-	-	7500	10000	13000
			kW	-	-	-	2.2	2.9	3.8
	Sound Level * 3)	Cooling (High/Low)	dB	32/29	36/32	38/35	32/29	36/32	38/35
		Heating (High/Low)	dB	-	-	-	32/29	36/32	38/35
Power	Fan output	Type	-	Cross fan	Cross fan	Cross fan	Cross fan	Cross fan	Cross fan
		Output	Watt	13	14	16	13	14	16
		Air flow rate	m <sup>3</sup> /min	5.8	7.0	7.5	5.8/6.0	7.0/7.5	7.5/8.0
	Running current	Cooling	A	0.18	0.20	0.23	0.18	0.20	0.23
		Heating	A	-	-	-	0.18	0.20	0.23
	Power input	Cooling	Watt	35	40	45	35	40	45
		Heating	Watt	-	-	-	35	40	45
	Others	Connecting pipe	Liquid	mm	6.35	6.35	6.35	6.35	6.35
Gas			mm	12.70	12.70	12.70	12.70	12.70	12.70
Drain			mm	18	18	18	18	18	18
Size	Net weight		kg	15	15	15	15	15	15
	Shipping weight		kg	18	18	18	18	18	18
	Net dimension (WxHxD)		mm	970x180x390	970x180x390	970x180x390	970x180x390	970x180x390	970x180x390
	Shipping dimension(Carton/Case) (WxHxD)		mm	1168x302x467	1168x302x467	1168x302x467	1168x302x467	1168x302x467	1168x302x467
Panel	Net weight		kg	3.5	3.5	3.5	3.5	3.5	3.5
	Shipping weight		kg	6.2	6.2	6.2	6.2	6.2	6.2
	Net dimension (WxHxD)		mm	1180x35x460	1180x35x460	1180x35x460	1180x35x460	1180x35x460	1180x35x460
	Shipping dimension(Carton/Case) (WxHxD)		mm	1259x144x539	1259x144x539	1259x144x539	1259x144x539	1259x144x539	1259x144x539
	Air filter		-	0	0	0	0	0	0
Function / Option	Auto restart		Yes/No	No	No	No	Yes	Yes	Yes
	Auto change over		Yes/No	No	No	No	No	No	No
	Centralized controller (On/Off)		Yes/No	Yes (Option)	Yes (Option)	Yes (Option)	Yes (Option)	Yes (Option)	Yes (Option)
	Group/Individual control from R/C		Yes/No	Yes (Option)	Yes (Option)	Yes (Option)	Yes (Option)	Yes (Option)	Yes (Option)
	Troubleshooting by L.E.D		Yes/No	Yes	Yes	Yes	Yes	Yes	Yes
	Auto swing (Up/Down)		Yes/No	Yes	Yes	Yes	Yes	Yes	Yes
	Max. installation ceiling height		mm	195	195	195	195	195	195
	Drain pump		Yes/No	Yes	Yes	Yes	Yes	Yes	Yes
	Certifications		-	-	-	-	-	-	-

\* 1) Indoor temperature : 27°C DB, 19°C WB / Outdoor temperature : 35°C DB, 24°C WB / Piping length : 10m, difference : 0m

\* 2) Indoor temperature : 20°C DB / Outdoor temperature : 7°C DB, 6°C WB / Piping length : 10m, difference : 0m

\* 3) Actual noise level may differ, depending on the room structure, etc, since these noise values are from an anechoic room.

## (2) 60Hz

Model				AVMKC020CA0	AVMKC032CA0	AVMKC040CA0	AVMKH020CA0	AVMKH032CA0	AVMKH040CA0
Power supply			ø, V, Hz	1, 208 ~ 230, 60					
Remark				Cooling only			Heat pump		
Performance	Capacity	Cooling * 1)	Btu/h	7000	11000	13500	7000	11000	13500
			kW	2.0	3.2	4.0	2.0	3.2	4.0
		Heating * 2)	Btu/h	-	-	-	7500	12000	14500
			kW	-	-	-	2.2	3.5	4.3
	Sound Level * 3)	Cooling (High/Low)	dB	32/29	36/32	38/35	32/29	36/32	38/35
Heating (High/Low)		dB	-	-	-	32/29	36/32	38/35	
Power	Fan output	Type	-	Cross fan	Cross fan	Cross fan	Cross fan	Cross fan	Cross fan
		Output	Watt	13	14	16	13	14	16
		Air flow rate	m <sup>3</sup> /min	5.8	7.5	8.0	5.8/6.0	7.5/8.0	8.0/8.5
	Running current	Cooling	A	0.18	0.20	0.23	0.18	0.20	0.23
		Heating	A	-	-	-	0.18	0.20	0.23
	Power input	Cooling	Watt	35	40	45	35	40	45
Heating		Watt	-	-	-	35	40	45	
Others	Connecting pipe	Liquid	mm	6.35	6.35	6.35	6.35	6.35	6.35
		Gas	mm	12.70	12.70	12.70	12.70	12.70	12.70
		Drain	mm	18	18	18	18	18	18
Size	Net weight		kg	15	15	15	15	15	15
	Shipping weight		kg	18	18	18	18	18	18
	Net dimension (WxHxD)		mm	970x180x390	970x180x390	970x180x390	970x180x390	970x180x390	970x180x390
	Shipping dimension(Carton/Case) (WxHxD)		mm	1168x302x467	1168x302x467	1168x302x467	1168x302x467	1168x302x467	1168x302x467
Panel	Net weight		kg	3.5	3.5	3.5	3.5	3.5	3.5
	Shipping weight		kg	6.2	6.2	6.2	6.2	6.2	6.2
	Net dimension (WxHxD)		mm	1180x35x460	1180x35x460	1180x35x460	1180x35x460	1180x35x460	1180x35x460
	Shipping dimension(Carton/Case) (WxHxD)		mm	1259x144x539	1259x144x539	1259x144x539	1259x144x539	1259x144x539	1259x144x539
	Air filter		-	0	0	0	0	0	0
Function / Option	Auto restart		Yes/No	No	No	No	Yes	Yes	Yes
	Auto change over		Yes/No	No	No	No	No	No	No
	Centralized controller (On/Off)		Yes/No	Yes (Option)	Yes (Option)	Yes (Option)	Yes (Option)	Yes (Option)	Yes (Option)
	Group/Individual control from R/C		Yes/No	Yes (Option)	Yes (Option)	Yes (Option)	Yes (Option)	Yes (Option)	Yes (Option)
	Troubleshooting by L.E.D		Yes/No	Yes	Yes	Yes	Yes	Yes	Yes
	Auto swing (Up/Down)		Yes/No	Yes	Yes	Yes	Yes	Yes	Yes
	Max. installation ceiling height		mm	195	195	195	195	195	195
	Drain pump		Yes/No	Yes	Yes	Yes	Yes	Yes	Yes
Certifications		-							

\* 1) Indoor temperature : 27°C DB, 19°C WB / Outdoor temperature : 35°C DB, 24°C WB / Piping length : 10m, difference : 0m

\* 2) Indoor temperature : 20°C DB / Outdoor temperature : 7°C DB, 6°C WB / Piping length : 10m, difference : 0m

\* 3) Actual noise level may differ, depending on the room structure, etc, since these noise values are from an anechoic room.



## 2. Specification

### 2-2. 4-way cassette type

#### (1) 50Hz

Model				AVMCC052EA0	AVMCC070EA0	AVMCC105EA0	AVMCH052EA0	AVMCH070EA0	AVMCH105EA0
Power supply			ø, V, Hz	1, 220 - 240, 50					
Remark				Cooling only			Heat pump		
Performance	Capacity	Cooling * 1)	Btu/h	18000	24000	36000	18000	24000	36000
			kW	5.2	7.0	10.5	5.2	7.0	10.5
		Heating * 2)	Btu/h	-	-	-	19000	26000	39000
			kW	-	-	-	5.6	7.6	11.4
	Sound Level * 3)	Cooling (High/Low)	dB	31/28	37/32	47/42	31/28	37/32	47/42
		Heating (High/Low)	dB	-	-	-	31/28	37/32	47/42
Power	Fan output	Type	-	Turbo fan	Turbo fan	Turbo fan	Turbo fan	Turbo fan	Turbo fan
		Output	Watt	51	53	84	51	53	84
		Air flow rate	m <sup>3</sup> /min	14	18	23	14/14.5	18/18.5	23/24
	Running current	Cooling	A	0.77	0.78	1.1	0.77	0.78	1.1
		Heating	A	-	-	-	0.77	0.78	1.1
	Power input	Cooling	Watt	145	150	240	145	150	240
		Heating	Watt	-	-	-	145	150	240
	Others	Connecting pipe	Liquid	mm	9.52	9.52	9.52	9.52	9.52
Gas			mm	15.88	15.88	19.05	15.88	15.88	19.05
Drain			mm	32	32	32	32	32	32
Size	Net weight		kg	31	31	34	31	31	34
	Shipping weight		kg	36	36	39	36	36	39
	Net dimension (WxHxD)		mm	840x240x840	840x240x840	840x298x840	840x240x840	840x240x840	840x298x840
	Shipping dimension(Carton/Case) (WxHxD)		mm	939x324x923	939x324x923	939x382x923	939x324x923	939x324x923	939x382x923
Panel	Net weight		kg	5	5	5	5	5	5
	Shipping weight		kg	10	10	10	10	10	10
	Net dimension (WxHxD)		mm	950x42x950	950x42x950	950x42x950	950x42x950	950x42x950	950x42x950
	Shipping dimension(Carton/Case) (WxHxD)		mm	1067x134x1067	1067x134x1067	1067x134x1067	1067x134x1067	1067x134x1067	1067x134x1067
	Air filter		-	0	0	0	0	0	0
Function / Option	Auto restart		Yes/No	No	No	No	Yes	Yes	Yes
	Auto change over		Yes/No	No	No	No	No	No	No
	Centralized controller (On/Off)		Yes/No	Yes(Optional)	Yes(Optional)	Yes(Optional)	Yes(Optional)	Yes(Optional)	Yes(Optional)
	Group/Individual control from R/C		Yes/No	Yes(Optional)	Yes(Optional)	Yes(Optional)	Yes(Optional)	Yes(Optional)	Yes(Optional)
	Troubleshooting by L.E.D		Yes/No	Yes	Yes	Yes	Yes	Yes	Yes
	Auto swing (Up/Down)		Yes/No	Yes	Yes	Yes	Yes	Yes	Yes
	Max. installation ceiling height		mm	255	255	315	255	255	315
	Drain pump		Yes/No	Yes	Yes	Yes	Yes	Yes	Yes
	Certifications		-						

\* 1) Indoor temperature : 27°C DB, 19°C WB / Outdoor temperature : 35°C DB, 24°C WB / Piping length : 10m, difference : 0m

\* 2) Indoor temperature : 20°C DB / Outdoor temperature : 7°C DB, 6°C WB / Piping length : 10m, difference : 0m

\* 3) Actual noise level may differ, depending on the room structure, etc, since these noise values are from an anechoic room.

## (2) 60Hz

Model				AVMCC052CA0 ABM1800B1	AVMCC072CA0 ABM2400B1	AVMCC105CA0	AVMCH052CA0	AVMCH072CA0	AVMCH105CA0
Power supply		ø, V, Hz		1, 208 ~ 230, 60					
Remark				Cooling only			Heat pump		
Performance	Capacity	Cooling * 1)	Btu/h	18000	24000	36000	18000	24000	36000
			kW	5.2	7.2	10.5	5.2	7.2	10.5
		Heating * 2)	Btu/h	-	-	-	19000	26000	39000
			kW	-	-	-	5.6	7.6	11.4
	Sound Level * 3)	Cooling (High/Low)	dB	31/28	37/32	47/42	31/28	37/32	47/42
Heating (High/Low)		dB	-	-	-	31/28	37/32	47/42	
Power	Fan output	Type	-	Turbo fan	Turbo fan	Turbo fan	Turbo fan	Turbo fan	Turbo fan
		Output	Watt	51	53	84	51	53	84
		Air flow rate	m <sup>3</sup> /min	14	18	23	14/14.5	18/18.5	23/24
	Running current	Cooling	A	0.77	0.78	1.1	0.77	0.78	1.1
		Heating	A	-	-	-	0.77	0.78	1.1
	Power input	Cooling	Watt	145	150	240	145	150	240
Heating		Watt	-	-	-	145	150	240	
Others	Connecting pipe	Liquid	mm	9.52	9.52	9.52	9.52	9.52	9.52
		Gas	mm	15.88	15.88	19.05	15.88	15.88	19.05
		Drain	mm	32	32	32	32	32	32
Size	Net weight		kg	31	31	34	31	31	34
	Shipping weight		kg	36	36	39	36	36	39
	Net dimension (WxHxD)		mm	840x240x840	840x240x840	840x298x840	840x240x840	840x240x840	840x298x840
	Shipping dimension(Carton/Case) (WxHxD)		mm	939x324x923	939x324x923	939x382x923	939x324x923	939x324x923	939x382x923
Panel	Net weight		kg	5	5	5	5	5	5
	Shipping weight		kg	10	10	10	10	10	10
	Net dimension (WxHxD)		mm	950x42x950	950x42x950	950x42x950	950x42x950	950x42x950	950x42x950
	Shipping dimension(Carton/Case) (WxHxD)		mm	1067x134x1067	1067x134x1067	1067x134x1067	1067x134x1067	1067x134x1067	1067x134x1067
	Air filter		-	0	0	0	0	0	0
Function / Option	Auto restart		Yes/No	No	No	No	Yes	Yes	Yes
	Auto change over		Yes/No	No	No	No	No	No	No
	Centralized controller (On/Off)		Yes/No	Yes(Optional)	Yes(Optional)	Yes(Optional)	Yes(Optional)	Yes(Optional)	Yes(Optional)
	Group/Individual control from R/C		Yes/No	Yes(Optional)	Yes(Optional)	Yes(Optional)	Yes(Optional)	Yes(Optional)	Yes(Optional)
	Troubleshooting by L.E.D		Yes/No	Yes	Yes	Yes	Yes	Yes	Yes
	Auto swing (Up/Down)		Yes/No	Yes	Yes	Yes	Yes	Yes	Yes
	Max. installation ceiling height		mm	255	255	315	255	255	315
	Drain pump		Yes/No	Yes	Yes	Yes	Yes	Yes	Yes
Certifications		-	-	-	-	-	-	-	

\* 1) Indoor temperature : 27°C DB, 19°C WB / Outdoor temperature : 35°C DB, 24°C WB / Piping length : 10m, difference : 0m

\* 2) Indoor temperature : 20°C DB / Outdoor temperature : 7°C DB, 6°C WB / Piping length : 10m, difference : 0m

\* 3) Actual noise level may differ, depending on the room structure, etc, since these noise values are from an anechoic room.



## 2. Specification

### 2-3. Duct type (Low silhouette)

#### (1) 50Hz

Model				AVMDC052EA0	AVMDC070EA0	AVMDH052EA0	AVMDH070EA0
Power supply			ø, V, Hz	1, 220 ~ 240, 50			
Remark				Cooling only		Heat pump	
Performance	Capacity	Cooling * 1)	Btu/h	18000	24000	18000	24000
			kW	5.2	7.0	5.2	7.0
		Heating * 2)	Btu/h	-	-	19000	26000
			kW	-	-	5.6	7.6
	Sound Level * 3)	Cooling (High/Low)	dB	35/32	38/36	35/32	38/36
		Heating (High/Low)	dB	-	-	35/32	38/36
Power	Fan output (4mmAq)	Type	-	Sirocco	Sirocco	Sirocco	Sirocco
		Output	Watt	51	81	51	81
		Air flow rate	m <sup>3</sup> /min	15	18	15/15.5	18/18.5
	Running current	Cooling	A	0.77	1.15	0.77	1.15
		Heating	A	-	-	0.77	1.15
	Power input	Cooling	Watt	145	231	145	231
		Heating	Watt	-	-	145	231
	Others	Connecting pipe	Liquid	mm	9.52	9.52	9.52
Gas			mm	15.88	15.88	15.88	15.88
Drain			mm	21	21	21	21
Size	Net weight		kg	41	41	41	41
	Shipping weight		kg	44	44	44	44
	Net dimension (WxHxD)		mm	1340x260x600	1340x260x600	1340x260x600	1340x260x600
	Shipping dimension(Carton/Case) (WxHxD)		mm	1514x389x749	1514x389x749	1514x389x749	1514x389x749
Function / Option	Auto restart		Yes/No	No	No	Yes	Yes
	Auto change over		Yes/No	No	No	No	No
	Centralized controller (On/Off)		Yes/No	Yes (Option)	Yes (Option)	Yes (Option)	Yes (Option)
	Group/Individual control from R/C		Yes/No	Yes (Option)	Yes (Option)	Yes (Option)	Yes (Option)
	Troubleshooting by L.E.D		Yes/No	Yes	Yes	Yes	Yes
	Auto swing (Up/Down)		Yes/No	No	No	No	No
	Max. installation ceiling height		mm	270	270	270	270
	Drain pump		Yes/No	Option	Option	Option	Option
	Certifications		-				

\* 1) Indoor temperature : 27°C DB, 19°C WB / Outdoor temperature : 35°C DB, 24°C WB / Piping length : 10m, difference : 0m

\* 2) Indoor temperature : 20°C DB / Outdoor temperature : 7°C DB, 6°C WB / Piping length : 10m, difference : 0m

\* 3) Actual noise level may differ, depending on the room structure, etc, since these noise values are from an anechoic room.

## (2) 60Hz

Model				AVMDC052CA0 ADM1800B1	AVMDC072CA0 ADM2400B1	AVMDH052CA0	AVMDH072CA0
Power supply			ø, V, Hz	1, 208 - 230, 60			
Remark				Cooling only		Heat pump	
Performance	Capacity	Cooling * 1)	Btu/h	18000	24000	18000	24000
			kW	5.2	7.2	5.2	7.2
		Heating * 2)	Btu/h	-	-	19000	26000
			kW	-	-	5.6	7.6
	Sound Level * 3)	Cooling (High/Low)	dB	35/32	38/36	35/32	38/36
		Heating (High/Low)	dB	-	-	35/32	38/36
Power	Fan output	Type	-	Sirocco	Sirocco	Sirocco	Sirocco
		Output	Watt	51	81	51	81
		Air flow rate	m <sup>3</sup> /min	15	18	15/15.5	18/18.5
	Running current	Cooling	A	0.77	1.15	0.77	1.15
		Heating	A	-	-	0.77	1.15
	Power input	Cooling	Watt	145	231	145	231
		Heating	Watt	-	-	145	231
Others	Connecting pipe	Liquid	mm	9.52	9.52	9.52	9.52
		Gas	mm	15.88	15.88	15.88	15.88
		Drain	mm	21	21	21	21
Size	Net weight		kg	41	41	41	41
	Shipping weight		kg	44	44	44	44
	Net dimension (WxHxD)		mm	1340x260x600	1340x260x600	1340x260x600	1340x260x600
	Shipping dimension(Carton/Case) (WxHxD)		mm	1514x389x749	1514x389x749	1514x389x749	1514x389x749
Function / Option	Auto restart		Yes/No	No	No	Yes	Yes
	Auto change over		Yes/No	No	No	No	No
	Centralized controller (On/Off)		Yes/No	Yes (Option)	Yes (Option)	Yes (Option)	Yes (Option)
	Group/Individual control from R/C		Yes/No	Yes (Option)	Yes (Option)	Yes (Option)	Yes (Option)
	Troubleshooting by L.E.D		Yes/No	Yes	Yes	Yes	Yes
	Auto swing (Up/Down)		Yes/No	No	No	No	No
	Max. installation ceiling height		mm	270	270	270	270
	Drain pump		Yes/No	Option	Option	Option	Option
	Certifications		-				

\* 1) Indoor temperature : 27°C DB, 19°C WB / Outdoor temperature : 35°C DB, 24°C WB / Piping length : 10m, difference : 0m

\* 2) Indoor temperature : 20°C DB / Outdoor temperature : 7°C DB, 6°C WB / Piping length : 10m, difference : 0m

\* 3) Actual noise level may differ, depending on the room structure, etc, since these noise values are from an anechoic room.



## 2. Specification

### 2-4. Duct type (Built-in) (1) 50Hz

Model				AVMBC020EA0	AVMBC026EA0	AVMBC035EA0	AVMBC052EA0	AVMBC070EA0
Power supply			ø, V, Hz	1, 220 ~ 240, 50				
Remark				Cooling only				
Performance	Capacity	Cooling * 1)	Btu/h	7000	9000	12000	18000	24000
			kW	2.0	2.6	3.5	5.2	7.0
		Heating * 2)	Btu/h	-	-	-	-	-
			kW	-	-	-	-	-
	Sound Level * 3)	Cooling (High/Low)	dB	37/34	41/38	42/39	43/40	45/42
		Heating (High/Low)	dB	-	-	-	-	-
Power	Fan output	Type	-	Sirocco	Sirocco	Sirocco	Sirocco	Sirocco
		Output	Watt	39	42	44	53	63
		Air flow rate	m <sup>3</sup> /min	8.2	9.2	10.0	16.5	18.8
	Running current	Cooling	A	0.5	0.55	0.57	0.76	0.9
		Heating	A	-	-	-	-	-
	Power input	Cooling	Watt	110	120	125	150	180
Heating		Watt	-	-	-	-	-	
Others	Connecting pipe	Liquid	mm	6.35	6.35	6.35	9.52	9.52
		Gas	mm	12.70	12.70	12.70	15.88	15.88
		Drain	mm	29	29	29	29	29
Size	Net weight		kg	27	27	27	38	38
	Shipping weight		kg	31	31	31	44	44
	Net dimension (WxHxD)		mm	550x300x800	550x300x800	550x300x800	1020x300x800	1020x300x800
	Shipping dimension(Carton/Case) (WxHxD)		mm	747x378x911	747x378x911	747x378x911	1214x378x911	1214x378x911
Panel	Net weight		kg	3	3	3	5	5
	Shipping weight		kg	-	-	-	-	-
	Net dimension (WxHxD)		mm	650x55x500	650x55x500	650x55x500	1100x55x500	1100x55x500
	Shipping dimension(Carton/Case) (WxHxD)		mm	-	-	-	-	-
	Air filter		-	Resin net	Resin net	Resin net	Resin net	Resin net
Function / Option	Auto restart		Yes/No	No	No	No	No	No
	Auto change over		Yes/No	No	No	No	No	No
	Centralized controller (On/Off)		Yes/No	Yes (Option)	Yes (Option)	Yes (Option)	Yes (Option)	Yes (Option)
	Group/Individual control from R/C		Yes/No	Yes (Option)	Yes (Option)	Yes (Option)	Yes (Option)	Yes (Option)
	Troubleshooting by L.E.D		Yes/No	Yes	Yes	Yes	Yes	Yes
	Auto swing (Up/Down)		Yes/No	Yes	Yes	Yes	Yes	Yes
	Drain pump		Yes/No	Option	Option	Option	Option	Option
	Certifications		-					

\* 1) Indoor temperature : 27°C DB, 19°C WB / Outdoor temperature : 35°C DB, 24°C WB / Piping length : 10m, difference : 0m

\* 2) Indoor temperature : 20°C DB / Outdoor temperature : 7°C DB, 6°C WB / Piping length : 10m, difference : 0m

\* 3) Actual noise level may differ, depending on the room structure, etc, since these noise values are from an anechoic room.



Model				AVMBH020EA0	AVMBH026EA0	AVMBH035EA0	AVMBH052EA0	AVMBH070EA0
Power supply			ø, V, Hz	1, 220 ~ 240, 50				
Remark				Heat pump				
Performance	Capacity	Cooling * 1)	Btu/h	7000	9000	12000	18000	24000
			kW	2.0	2.6	3.5	5.2	7.0
		Heating * 2)	Btu/h	7500	10000	13000	19000	26000
			kW	2.2	2.9	3.8	5.6	7.6
	Sound Level * 3)	Cooling (High/Low)	dB	37/34	41/38	42/39	43/40	45/42
Heating (High/Low)		dB	37/34	41/38	42/39	43/40	45/42	
Power	Fan output	Type	-	Sirocco	Sirocco	Sirocco	Sirocco	Sirocco
		Output	Watt	39	42	44	53	63
		Air flow rate	m <sup>3</sup> /min	8.2/8.7	9.2/9.7	10/10.5	16.5/17	18.8/19.3
	Running current	Cooling	A	0.5	0.55	0.57	0.76	0.9
		Heating	A	0.5	0.55	0.57	0.76	0.9
	Power input	Cooling	Watt	110	120	125	150	180
Heating		Watt	110	120	125	150	180	
Others	Connecting pipe	Liquid	mm	6.35	6.35	6.35	9.52	9.52
		Gas	mm	12.70	12.70	12.70	15.88	15.88
		Drain	mm	29	29	29	29	29
Size	Net weight		kg	27	27	27	38	38
	Shipping weight		kg	31	31	31	44	44
	Net dimension (WxHxD)		mm	550x300x800	550x300x800	550x300x800	1020x300x800	1020x300x800
	Shipping dimension(Carton/Case) (WxHxD)		mm	747x378x911	747x378x911	747x378x911	1214x378x911	1214x378x911
Panel	Net weight		kg	3	3	3	5	5
	Shipping weight		kg	-	-	-	-	-
	Net dimension (WxHxD)		mm	650x55x500	650x55x500	650x55x500	1100x55x500	1100x55x500
	Shipping dimension(Carton/Case) (WxHxD)		mm	-	-	-	-	-
	Air filter		-	Resin net	Resin net	Resin net	Resin net	Resin net
Function / Option	Auto restart		Yes/No	Yes	Yes	Yes	Yes	Yes
	Auto change over		Yes/No	No	No	No	No	No
	Centralized controller (On/Off)		Yes/No	Yes (Option)	Yes (Option)	Yes (Option)	Yes (Option)	Yes (Option)
	Group/Individual control from R/C		Yes/No	Yes (Option)	Yes (Option)	Yes (Option)	Yes (Option)	Yes (Option)
	Troubleshooting by L.E.D		Yes/No	Yes	Yes	Yes	Yes	Yes
	Auto swing (Up/Down)		Yes/No	Yes	Yes	Yes	Yes	Yes
	Drain pump		Yes/No	Option	Option	Option	Option	Option
	Certifications		-					

\* 1) Indoor temperature : 27°C DB, 19°C WB / Outdoor temperature : 35°C DB, 24°C WB / Piping length : 10m, difference : 0m

\* 2) Indoor temperature : 20°C DB / Outdoor temperature : 7°C DB, 6°C WB / Piping length : 10m, difference : 0m

\* 3) Actual noise level may differ, depending on the room structure, etc, since these noise values are from an anechoic room.



## 2. Specification

### (2) 60Hz

Model				AVMBC020CA0	AVMBC032CA0	AVMBC040CA0	AVMBC052CA0	AVMBC072CA0
Power supply			ø, V, Hz	1, 208 - 230, 60				
Remark				Cooling only				
Performance	Capacity	Cooling * 1)	Btu/h	7000	11000	13500	18000	24000
			kW	2.0	3.2	4.0	5.2	7.2
		Heating * 2)	Btu/h	-	-	-	-	-
			kW	-	-	-	-	-
	Sound Level * 3)	Cooling (High/Low)	dB	37/34	41/38	42/39	43/40	45/42
		Heating (High/Low)	dB	-	-	-	-	-
Power	Fan output	Type	-	Sirocco	Sirocco	Sirocco	Sirocco	Sirocco
		Output	Watt	39	42	44	53	63
		Air flow rate	m <sup>3</sup> /min	8.2	9.2	10.0	16.5	18.8
	Running current	Cooling	A	0.5	0.55	0.57	0.76	0.9
		Heating	A	-	-	-	-	-
	Power input	Cooling	Watt	110	120	125	150	180
Heating		Watt	-	-	-	-	-	
Others	Connecting pipe	Liquid	mm	6.35	6.35	6.35	9.52	9.52
		Gas	mm	12.70	12.70	12.70	15.88	15.88
		Drain	mm	29	29	29	29	29
Size	Net weight		kg	27	27	27	38	38
	Shipping weight		kg	31	31	31	44	44
	Net dimension (WxHxD)		mm	550x300x800	550x300x800	550x300x800	1020x300x800	1020x300x800
	Shipping dimension(Carton/Case) (WxHxD)		mm	747x378x911	747x378x911	747x378x911	1214x378x911	1214x378x911
Panel	Net weight		kg	3	3	3	5	5
	Shipping weight		kg	-	-	-	-	-
	Net dimension (WxHxD)		mm	650x55x500	650x55x500	650x55x500	1100x55x500	1100x55x500
	Shipping dimension(Carton/Case) (WxHxD)		mm	-	-	-	-	-
	Air filter		-	Resin net	Resin net	Resin net	Resin net	Resin net
Function / Option	Auto restart		Yes/No	No	No	No	No	No
	Auto change over		Yes/No	No	No	No	No	No
	Centralized controller (On/Off)		Yes/No	Yes (Option)	Yes (Option)	Yes (Option)	Yes (Option)	Yes (Option)
	Group/Individual control from R/C		Yes/No	Yes (Option)	Yes (Option)	Yes (Option)	Yes (Option)	Yes (Option)
	Troubleshooting by L.E.D		Yes/No	Yes	Yes	Yes	Yes	Yes
	Auto swing (Up/Down)		Yes/No	Yes	Yes	Yes	Yes	Yes
	Drain pump		Yes/No	Option	Option	Option	Option	Option
	Certifications		-					

\* 1) Indoor temperature : 27°C DB, 19°C WB / Outdoor temperature : 35°C DB, 24°C WB / Piping length : 10m, difference : 0m

\* 2) Indoor temperature : 20°C DB / Outdoor temperature : 7°C DB, 6°C WB / Piping length : 10m, difference : 0m

\* 3) Actual noise level may differ, depending on the room structure, etc, since these noise values are from an anechoic room.

Model				AVMBH020CA0	AVMBH032CA0	AVMBH040CA0	AVMBH052CA0	AVMBH072CA0
Power supply			ø, V, Hz	1, 208 - 230, 60				
Remark				Heat pump				
Performance	Capacity	Cooling * 1)	Btu/h	7000	11000	13500	18000	24000
			kW	2.0	3.2	4.0	5.2	7.2
		Heating * 2)	Btu/h	7500	12000	14500	19000	26000
			kW	2.2	3.5	4.3	5.6	7.6
	Sound Level * 3)	Cooling (High/Low)	dB	37/34	41/38	42/39	43/40	45/42
Heating (High/Low)		dB	37/34	41/38	42/39	43/40	45/42	
Power	Fan output	Type	-	Sirocco	Sirocco	Sirocco	Sirocco	Sirocco
		Output	Watt	39	42	44	53	63
		Air flow rate	m <sup>3</sup> /min	8.2/8.7	9.2/9.7	10/10.5	16.5/17	18.8/19.3
	Running current	Cooling	A	0.5	0.55	0.57	0.76	0.9
		Heating	A	0.5	0.55	0.57	0.76	0.9
	Power input	Cooling	Watt	110	120	125	150	180
Heating		Watt	110	120	125	150	180	
Others	Connecting pipe	Liquid	mm	6.35	6.35	6.35	9.52	9.52
		Gas	mm	12.70	12.70	12.70	15.88	15.88
		Drain	mm	29	29	29	29	29
Size	Net weight		kg	27	27	27	38	38
	Shipping weight		kg	31	31	31	44	44
	Net dimension (WxHxD)		mm	550x300x800	550x300x800	550x300x800	1020x300x800	1020x300x800
	Shipping dimension(Carton/Case) (WxHxD)		mm	747x378x911	747x378x911	747x378x911	1214x378x911	1214x378x911
Panel	Net weight		kg	3	3	3	5	5
	Shipping weight		kg	-	-	-	-	-
	Net dimension (WxHxD)		mm	650x55x500	650x55x500	650x55x500	1110x55x500	1110x55x500
	Shipping dimension(Carton/Case) (WxHxD)		mm	-	-	-	-	-
	Air filter		-	Resin net	Resin net	Resin net	Resin net	Resin net
Function / Option	Auto restart		Yes/No	Yes	Yes	Yes	Yes	Yes
	Auto change over		Yes/No	No	No	No	No	No
	Centralized controller (On/Off)		Yes/No	Yes (Option)	Yes (Option)	Yes (Option)	Yes (Option)	Yes (Option)
	Group/Individual control from R/C		Yes/No	Yes (Option)	Yes (Option)	Yes (Option)	Yes (Option)	Yes (Option)
	Troubleshooting by L.E.D		Yes/No	Yes	Yes	Yes	Yes	Yes
	Auto swing (Up/Down)		Yes/No	Yes	Yes	Yes	Yes	Yes
	Drain pump		Yes/No	Option	Option	Option	Option	Option
	Certifications		-					

\* 1) Indoor temperature : 27°C DB, 19°C WB / Outdoor temperature : 35°C DB, 24°C WB / Piping length : 10m, difference : 0m

\* 2) Indoor temperature : 20°C DB / Outdoor temperature : 7°C DB, 6°C WB / Piping length : 10m, difference : 0m

\* 3) Actual noise level may differ, depending on the room structure, etc, since these noise values are from an anechoic room.



## 2. Specification

### 2-5. Duct type (High pressure)

#### (1) 50Hz

Model				AVMHC105EA0	AVMHC128EA0	AVMHH105EA0	AVMHH128EA0
Power supply			ø, V, Hz	1, 220 ~ 240, 50			
Remark				Cooling only		Heat pump	
Performance	Capacity	Cooling * 1)	Btu/h	36000	44000	36000	44000
			kW	10.5	12.8	10.5	12.8
		Heating * 2)	Btu/h	-	-	39000	47000
			kW	-	-	11.4	13.8
	Sound Level * 3)	Cooling (High/Low)	dB	45/44	45/44	45/44	45/44
		Heating (High/Low)	dB	-	-	45/44	45/44
Power	Fan output	Type	-	Sirocco	Sirocco	Sirocco	Sirocco
		Output	Watt	189	210	189	210
		Air flow rate	m <sup>3</sup> /min	29	32	29/30	32/33
	Running current	Cooling	A	2.52	2.76	2.52	2.76
		Heating	A	-	-	2.52	2.76
	Power input	Cooling	Watt	540	600	540	540
		Heating	Watt	-	-	600	600
	Others	Connecting pipe	Liquid	mm	9.52	9.52	9.52
Gas			mm	19.05	19.05	19.05	19.05
Drain			mm	27	27	27	27
Size	Net weight		kg	70	70	70	70
	Shipping weight		kg	78	78	78	78
	Net dimension (WxHxD)		mm	1110x390x650	1110x390x650	1110x390x650	1110x390x650
	Shipping dimension(Carton/Case) (WxHxD)		mm	1329x512x829	1329x512x829	1329x512x829	1329x512x829
	Air filter		-	O	O	O	O
Function / Option	Auto restart		Yes/No	No	No	Yes	Yes
	Auto change over		Yes/No	No	No	No	No
	Centralized controller (On/Off)		Yes/No	Yes (Option)	Yes (Option)	Yes (Option)	Yes (Option)
	Group/Individual control from R/C		Yes/No	Yes (Option)	Yes (Option)	Yes (Option)	Yes (Option)
	Troubleshooting by L.E.D		Yes/No	Yes	Yes	Yes	Yes
	Auto swing (Up/Down)		Yes/No	No	No	No	No
	Max. installation ceiling height		mm	410	410	410	410
	Drain pump		Yes/No	Option	Option	Option	Option
	Certifications		-				

\* 1) Indoor temperature : 27°C DB, 19°C WB / Outdoor temperature : 35°C DB, 24°C WB / Piping length : 10m, difference : 0m

\* 2) Indoor temperature : 20°C DB / Outdoor temperature : 7°C DB, 6°C WB / Piping length : 10m, difference : 0m

\* 3) Actual noise level may differ, depending on the room structure, etc, since these noise values are from an anechoic room.

## (2) 60Hz

Model				AVMHC105CA0	AVMHC128CA0	AVMHH105CA0	AVMHH128CA0
Power supply			ø, V, Hz	1, 208 ~ 230, 60			
Remark				Cooling only		Heat pump	
Performance	Capacity	Cooling * 1)	Btu/h	36000	44000	36000	44000
			kW	10.5	12.8	10.5	12.8
		Heating * 2)	Btu/h	-	-	39000	47000
			kW	-	-	11.4	13.8
	Sound Level * 3)	Cooling (High/Low)	dB	45/44	45/44	45/44	45/44
Heating (High/Low)		dB	-	-	45/44	45/44	
Power	Fan output	Type	-	Sirocco	Sirocco	Sirocco	Sirocco
		Output	Watt	193	214	193	214
		Air flow rate	m <sup>3</sup> /min	29	32	29/30	32/33
	Running current	Cooling	A	2.55	2.81	2.55	2.81
		Heating	A	-	-	2.55	2.81
	Power input	Cooling	Watt	550	610	550	610
Heating		Watt	-	-	550	610	
Others	Connecting pipe	Liquid	mm	9.52	9.52	9.52	9.52
		Gas	mm	19.05	19.05	19.05	19.05
		Drain	mm	27	27	27	27
Size	Net weight		kg	70	70	70	70
	Shipping weight		kg	78	78	78	78
	Net dimension (WxHxD)		mm	1110x390x650	1110x390x650	1110x390x650	1110x390x650
	Shipping dimension(Carton/Case) (WxHxD)		mm	1329x512x829	1329x512x829	1329x512x829	1329x512x829
	Air filter		-	O	O	O	O
Function / Option	Auto restart		Yes/No	No	No	Yes	Yes
	Auto change over		Yes/No	No	No	No	No
	Centralized controller (On/Off)		Yes/No	Yes (Option)	Yes (Option)	Yes (Option)	Yes (Option)
	Group/Individual control from R/C		Yes/No	Yes (Option)	Yes (Option)	Yes (Option)	Yes (Option)
	Troubleshooting by L.E.D		Yes/No	Yes	Yes	Yes	Yes
	Auto swing (Up/Down)		Yes/No	No	No	No	No
	Max. installation ceiling height		mm	410	410	410	410
	Drain pump		Yes/No	Option	Option	Option	Option
	Certifications		-				

\* 1) Indoor temperature : 27°C DB, 19°C WB / Outdoor temperature : 35°C DB, 24°C WB / Piping length : 10m, difference : 0m

\* 2) Indoor temperature : 20°C DB / Outdoor temperature : 7°C DB, 6°C WB / Piping length : 10m, difference : 0m

\* 3) Actual noise level may differ, depending on the room structure, etc, since these noise values are from an anechoic room.



## 2. Specification

### 2-6. Wall-mounted type

#### (1) 50Hz

Model				AVMWC020EA0	AVMWC026EA0	AVMWC035EA0	AVMWC052EA0	AVMWC070EA0
Power supply			ø, V, Hz	1, 220 - 240, 50				
Remark				Cooling only				
Performance	Capacity	Cooling * 1)	Btu/h	7000	9000	12000	18000	24000
			kW	2.0	2.6	3.5	5.2	7.0
		Heating * 2)	Btu/h	-	-	-	-	-
			kW	-	-	-	-	-
	Sound Level * 3)	Cooling (High/Low)	dB	29/28	34/30	38/35	41/37	44/41
		Heating (High/Low)	dB	-	-	-	-	-
Power	Fan output	Type	-	Cross fan	Cross fan	Cross fan	Cross fan	Cross fan
		Output	Watt	13	14	16	21	21
		Air flow rate	m <sup>3</sup> /min	5.5	6.5	7.8	12.7	14.0
	Running current	Cooling	A	0.22	0.22	0.23	0.35	0.35
		Heating	A	-	-	-	-	-
	Power input	Cooling	Watt	35	40	45	60	60
Heating		Watt	-	-	-	-	-	
Others	Connecting pipe	Liquid	mm	6.35	6.35	6.35	9.52	9.52
		Gas	mm	12.70	12.70	12.70	15.88	15.88
		Drain	mm	18	18	18	18	18
Size	Net weight		kg	7.7	7.7	7.7	13	13
	Shipping weight		kg	8.9	8.9	8.9	16	16
	Net dimension (WxHxD)		mm	790x245x165	790x245x165	790x245x165	1080x275x204	1080x275x204
	Shipping dimension(Carton/Case) (WxHxD)		mm	842x297x236	842x297x236	842x297x236	1151x352x277	1151x352x277
Function / Option	Auto restart		Yes/No	No	No	No	No	No
	Auto change over		Yes/No	No	No	No	No	No
	Centralized controller (On/Off)		Yes/No	Yes (Option)	Yes (Option)	Yes (Option)	Yes (Option)	Yes (Option)
	Group/Individual control from R/C		Yes/No	Yes (Option)	Yes (Option)	Yes (Option)	Yes (Option)	Yes (Option)
	Troubleshooting by L.E.D		Yes/No	Yes	Yes	Yes	Yes	Yes
	Auto swing (Up/Down)		Yes/No	Yes	Yes	Yes	Yes	Yes
	Drain pump		Yes/No	Option	Option	Option	Option	Option
	Certifications		-					

\* 1) Indoor temperature : 27°C DB, 19°C WB / Outdoor temperature : 35°C DB, 24°C WB / Piping length : 10m, difference : 0m

\* 2) Indoor temperature : 20°C DB / Outdoor temperature : 7°C DB, 6°C WB / Piping length : 10m, difference : 0m

\* 3) Actual noise level may differ, depending on the room structure, etc, since these noise values are from an anechoic room.

Model				AVMWH020EA0	AVMWH026EA0	AVMWH035EA0	AVMWH052EA0	AVMWH070EA0
Power supply			ø, V, Hz	1, 220 ~ 240, 50				
Remark				Heat pump				
Performance	Capacity	Cooling * 1)	Btu/h	7000	9000	12000	18000	24000
			kW	2.0	2.6	3.5	5.2	7.0
		Heating * 2)	Btu/h	7500	11000	13000	19000	26000
			kW	2.2	2.9	3.8	5.6	7.6
	Sound Level * 3)	Cooling (High/Low)	dB	29/28	34/30	38/35	41/37	44/41
Heating (High/Low)		dB	29/28	34/30	38/35	41/37	44/41	
Power	Fan output	Type	-	Cross fan	Cross fan	Cross fan	Cross fan	Cross fan
		Output	Watt	13	14	16	21	21
		Air flow rate	m <sup>3</sup> /min	5.5	6.5	7.8	12.7/13.2	14.0/14.5
	Running current	Cooling	A	0.22	0.22	0.23	0.35	0.35
		Heating	A	0.22	0.22	0.23	0.35	0.35
	Power input	Cooling	Watt	35	40	45	60	60
Heating		Watt	35	40	45	60	60	
Others	Connecting pipe	Liquid	mm	6.35	6.35	6.35	9.52	9.52
		Gas	mm	12.70	12.70	12.70	15.88	15.88
		Drain	mm	18	18	18	18	18
Size	Net weight		kg	7.7	7.7	7.7	13	13
	Shipping weight		kg	8.9	8.9	8.9	16	16
	Net dimension (WxHxD)		mm	790x245x165	790x245x165	790x245x165	1080x275x204	1080x275x204
	Shipping dimension(Carton/Case) (WxHxD)		mm	842x297x236	842x297x236	842x297x236	1151x352x277	1151x352x277
Function / Option	Auto restart		Yes/No	Yes	Yes	Yes	Yes	Yes
	Auto change over		Yes/No	No	No	No	No	No
	Centralized controller (On/Off)		Yes/No	Yes (Option)	Yes (Option)	Yes (Option)	Yes (Option)	Yes (Option)
	Group/Individual control from R/C		Yes/No	Yes (Option)	Yes (Option)	Yes (Option)	Yes (Option)	Yes (Option)
	Troubleshooting by L.E.D		Yes/No	Yes	Yes	Yes	Yes	Yes
	Auto swing (Up/Down)		Yes/No	Yes	Yes	Yes	Yes	Yes
	Drain pump		Yes/No	Option	Option	Option	Option	Option
	Certifications		-					

- \* 1) Indoor temperature : 27°C DB, 19°C WB / Outdoor temperature : 35°C DB, 24°C WB / Piping length : 10m, difference : 0m  
\* 2) Indoor temperature : 20°C DB / Outdoor temperature : 7°C DB, 6°C WB / Piping length : 10m, difference : 0m  
\* 3) Actual noise level may differ, depending on the room structure, etc, since these noise values are from an anechoic room.



## 2. Specification

### (2) 60Hz

Model				AVMWC020CA0	AVMWC032CA0	AVMWC040CA0	AVMWC052CA0	AVMWC072CA0
Power supply			ø, V, Hz	1, 208 - 230, 60				
Remark				Cooling only				
Performance	Capacity	Cooling * 1)	Btu/h	7000	11000	13500	18000	24000
			kW	2.0	3.2	4.0	5.2	7.2
		Heating * 2)	Btu/h	-	-	-	-	-
			kW	-	-	-	-	-
	Sound Level * 3)	Cooling (High/Low)	dB	29/28	34/30	38/35	41/37	44/41
		Heating (High/Low)	dB	-	-	-	-	-
Power	Fan output (4mmAq)	Type	-	Cross fan	Cross fan	Cross fan	Cross fan	Cross fan
		Output	Watt	13	14	16	21	21
		Air flow rate	m <sup>3</sup> /min	5.5	7.4	9.0	12.7	14.0
	Running current	Cooling	A	0.22	0.22	0.23	0.35	0.35
		Heating	A	-	-	-	-	-
	Power input	Cooling	Watt	35	40	45	60	60
Heating		Watt	-	-	-	-	-	
Others	Connecting pipe	Liquid	mm	6.35	6.35	6.35	9.52	9.52
		Gas	mm	12.70	12.70	12.70	15.88	15.88
		Drain	mm	18	18	18	18	18
Size	Net weight		kg	7.7	7.7	7.7	13	13
	Shipping weight		kg	8.9	8.9	8.9	16	16
	Net dimension (WxHxD)		mm	790x245x165	790x245x165	790x245x165	1080x275x204	1080x275x204
	Shipping dimension(Carton/Case) (WxHxD)		mm	842x297x236	842x297x236	842x297x236	1151x352x277	1151x352x277
Function / Option	Auto restart		Yes/No	No	No	No	No	No
	Auto change over		Yes/No	No	No	No	No	No
	Centralized controller (On/Off)		Yes/No	Yes (Option)	Yes (Option)	Yes (Option)	Yes (Option)	Yes (Option)
	Group/Individual control from R/C		Yes/No	Yes (Option)	Yes (Option)	Yes (Option)	Yes (Option)	Yes (Option)
	Troubleshooting by L.E.D		Yes/No	Yes	Yes	Yes	Yes	Yes
	Auto swing (Up/Down)		Yes/No	Yes	Yes	Yes	Yes	Yes
	Drain pump		Yes/No	Option	Option	Option	Option	Option
	Certifications		-					

\* 1) Indoor temperature : 27°C DB, 19°C WB / Outdoor temperature : 35°C DB, 24°C WB / Piping length : 10m, difference : 0m

\* 2) Indoor temperature : 20°C DB / Outdoor temperature : 7°C DB, 6°C WB / Piping length : 10m, difference : 0m

\* 3) Actual noise level may differ, depending on the room structure, etc, since these noise values are from an anechoic room.



Model				AVMWH02CA0	AVMWH032CA0	AVMWH040CA0	AVMWH052CA0	AVMWH072CA0
Power supply			ø, V, Hz	1, 208 - 230, 60				
Remark				Heat pump				
Performance	Capacity	Cooling * 1)	Btu/h	7000	11000	14500	18000	24000
			kW	2.0	3.2	4.3	5.2	7.2
		Heating * 2)	Btu/h	7500	12000	13200	19000	26000
			kW	2.2	3.5	3.9	5.6	7.6
	Sound Level * 3)	Cooling (High/Low)	dB	29/28	34/30	38/35	41/37	44/41
Heating (High/Low)		dB	29/28	34/30	38/35	41/37	44/41	
Power	Fan output (4mmAq)	Type	-	Cross fan	Cross fan	Cross fan	Cross fan	Cross fan
		Output	Watt	13	14	16	21	21
		Air flow rate	m <sup>3</sup> /min	5.5/6.0	7.5/8.0	9.0/9.5	12.7/13.2	14.0/14.5
	Running current	Cooling	A	0.22	0.22	0.23	0.35	0.35
		Heating	A	0.22	0.22	0.23	0.35	0.35
	Power input	Cooling	Watt	35	40	45	60	60
Heating		Watt	35	40	45	60	60	
Others	Connecting pipe	Liquid	mm	6.35	6.35	6.35	9.52	9.52
		Gas	mm	12.70	12.70	12.70	15.88	15.88
		Drain	mm	18	18	18	18	18
Size	Net weight		kg	7.7	7.7	7.7	13	13
	Shipping weight		kg	8.9	8.9	8.9	16	16
	Net dimension (WxHxD)		mm	790x245x165	790x245x165	790x245x165	1080x275x204	1080x275x204
	Shipping dimension(Carton/Case) (WxHxD)		mm	842x297x236	842x297x236	842x297x236	1151x352x277	1151x352x277
Function / Option	Auto restart		Yes/No	Yes	Yes	Yes	Yes	Yes
	Auto change over		Yes/No	No	No	No	No	No
	Centralized controller (On/Off)		Yes/No	Yes (Option)	Yes (Option)	Yes (Option)	Yes (Option)	Yes (Option)
	Group/Individual control from R/C		Yes/No	Yes (Option)	Yes (Option)	Yes (Option)	Yes (Option)	Yes (Option)
	Troubleshooting by L.E.D		Yes/No	Yes	Yes	Yes	Yes	Yes
	Auto swing (Up/Down)		Yes/No	Yes	Yes	Yes	Yes	Yes
	Drain pump		Yes/No	Option	Option	Option	Option	Option
	Certifications		-					

\* 1) Indoor temperature : 27°C DB, 19°C WB / Outdoor temperature : 35°C DB, 24°C WB / Piping length : 10m, difference : 0m

\* 2) Indoor temperature : 20°C DB / Outdoor temperature : 7°C DB, 6°C WB / Piping length : 10m, difference : 0m

\* 3) Actual noise level may differ, depending on the room structure, etc, since these noise values are from an anechoic room.



## 2. Specification

### 2-7. Floor standing type

#### (1) 50Hz

Model				AVMPC060EA0	AVMPC070EA0	AVMPC082EA0	AVMPH060EA0	AVMPH070EA0	AVMPH082EA0
Power supply			ø, V, Hz	1, 220 ~ 240, 50					
Remark				Cooling only			Heat pump		
Performance	Capacity	Cooling * 1)	Btu/h	20000	24000	28000	20000	24000	28000
			kW	6.0	7.0	8.2	6.0	7.0	8.2
		Heating * 2)	Btu/h	-	-	-	22000	26000	30000
			kW	-	-	-	6.4	7.6	8.8
	Sound Level * 3)	Cooling (High/Low)	dB	37/35	42/40	44/41	37/35	42/40	44/41
		Heating (High/Low)	dB	-	-	-	37/35	42/40	44/41
Power	Fan output	Type	-	Sirocco	Sirocco	Sirocco	Sirocco	Sirocco	Sirocco
		Output	Watt	63	63	63	63	63	63
		Air flow rate	m <sup>3</sup> /min	15	16	17	15/15.5	16/16.5	17/17.5
	Running current	Cooling	A	0.8	0.8	0.9	0.8	0.8	0.9
		Heating	A	-	-	-	0.8	0.8	0.9
	Power input	Cooling	Watt	180	180	180	180	180	180
		Heating	Watt	-	-	-	180	180	180
	Others	Connecting pipe	Liquid	mm	9.52	9.52	9.52	9.52	9.52
Gas			mm	15.88	15.88	15.88	15.88	15.88	15.88
Drain			mm	18	18	18	18	18	18
Size	Net weight		kg	49	51	51	49	51	51
	Shipping weight		kg	57	59	59	57	59	59
	Net dimension (WxHxD)		mm	600x1850x330	600x1850x330	600x1850x330	600x1850x330	600x1850x330	600x1850x330
	Shipping dimension(Carton/Case) (WxHxD)		mm	669x1930x433	669x1930x433	669x1930x433	669x1930x433	669x1930x433	669x1930x433
Function / Option	Auto restart		Yes/No	No	No	No	Yes	Yes	Yes
	Auto change over		Yes/No	No	No	No	No	No	No
	Centralized controller (On/Off)		Yes/No	Yes (Option)	Yes (Option)	Yes (Option)	Yes (Option)	Yes (Option)	Yes (Option)
	Group/Individual control from R/C		Yes/No	Yes (Option)	Yes (Option)	Yes (Option)	Yes (Option)	Yes (Option)	Yes (Option)
	Troubleshooting by L.E.D		Yes/No	Yes	Yes	Yes	Yes	Yes	Yes
	Auto swing (Up/Down)		Yes/No	Yes	Yes	Yes	Yes	Yes	Yes
	Drain pump		Yes/No	Option	Option	Option	Option	Option	Option
	Certifications		-						

\* 1) Indoor temperature : 27°C DB, 19°C WB / Outdoor temperature : 35°C DB, 24°C WB / Piping length : 10m, difference : 0m

\* 2) Indoor temperature : 20°C DB / Outdoor temperature : 7°C DB, 6°C WB / Piping length : 10m, difference : 0m

\* 3) Actual noise level may differ, depending on the room structure, etc, since these noise values are from an anechoic room.

## (2) 60Hz

Model				AVMPC060CA0	AVMPC072CA0	AVMPC083CA0	AVMPH060CA0	AVMPH072CA0	AVMPH083CA0
Power supply			ø, V, Hz	1, 208 ~ 230, 60					
Remark				Cooling only			Heat pump		
Performance	Capacity	Cooling * 1)	Btu/h	20000	24000	28000	20000	24000	28000
			kW	6.0	7.2	8.3	6.0	7.2	8.3
		Heating * 2)	Btu/h	-	-	-	22000	26000	30000
			kW	-	-	-	6.4	7.6	8.8
	Sound Level * 3)	Cooling (High/Low)	dB	37/35	42/40	44/41	37/35	42/40	44/41
Heating (High/Low)		dB	-	-	-	37/35	42/40	44/41	
Power	Fan output	Type	-	Sirocco	Sirocco	Sirocco	Sirocco	Sirocco	Sirocco
		Output	Watt	63	63	63	63	63	63
		Air flow rate	m <sup>3</sup> /min	15	16	17	15/15.5	16/16.5	17/17.5
	Running current	Cooling	A	0.8	0.8	0.9	0.8	0.8	0.9
		Heating	A	-	-	-	0.8	0.8	0.9
	Power input	Cooling	Watt	180	180	180	180	180	180
Heating		Watt	-	-	-	180	180	180	
Others	Connecting pipe	Liquid	mm	9.52	9.52	9.52	9.52	9.52	9.52
		Gas	mm	15.88	15.88	15.88	15.88	15.88	15.88
		Drain	mm	18	18	18	18	18	18
Size	Net weight		kg	49	51	51	49	51	51
	Shipping weight		kg	57	59	59	57	59	59
	Net dimension (WxHxD)		mm	600x1850x330	600x1850x330	600x1850x330	600x1850x330	600x1850x330	600x1850x330
	Shipping dimension(Carton/Case) (WxHxD)		mm	669x1930x433	669x1930x433	669x1930x433	669x1930x433	669x1930x433	669x1930x433
Function / Option	Auto restart		Yes/No	No	No	No	Yes	Yes	Yes
	Auto change over		Yes/No	No	No	No	No	No	No
	Centralized controller (On/Off)		Yes/No	Yes (Option)	Yes (Option)	Yes (Option)	Yes (Option)	Yes (Option)	Yes (Option)
	Group/Individual control from R/C		Yes/No	Yes (Option)	Yes (Option)	Yes (Option)	Yes (Option)	Yes (Option)	Yes (Option)
	Troubleshooting by L.E.D		Yes/No	Yes	Yes	Yes	Yes	Yes	Yes
	Auto swing (Up/Down)		Yes/No	Yes	Yes	Yes	Yes	Yes	Yes
	Drain pump		Yes/No	Option	Option	Option	Option	Option	Option
	Certifications		-						

\* 1) Indoor temperature : 27°C DB, 19°C WB / Outdoor temperature : 35°C DB, 24°C WB / Piping length : 10m, difference : 0m

\* 2) Indoor temperature : 20°C DB / Outdoor temperature : 7°C DB, 6°C WB / Piping length : 10m, difference : 0m

\* 3) Actual noise level may differ, depending on the room structure, etc, since these noise values are from an anechoic room.



## 2. Specification

### 2-8. Ceiling type

#### (1) 50Hz

Model				AVMFC052EA0	AVMFC070EA0	AVMFH052EA0	AVMFH070EA0
Power supply			ø, V, Hz	1, 220 ~ 240, 50			
Remark				Cooling only		Heat pump	
Performance	Capacity	Cooling * 1)	Btu/h	18000	24000	18000	24000
			kW	5.2	7.0	5.2	7.0
		Heating * 2)	Btu/h	-	-	19000	26000
			kW	-	-	5.6	7.6
	Sound Level * 3)	Cooling (High/Low)	dB	43/40	45/40	43/40	45/40
		Heating (High/Low)	dB	-	-	43/40	45/40
Power	Fan output	Type	-	Cross fan	Cross fan	Cross fan	Cross fan
		Output	Watt	51	53	51	53
		Air flow rate	m <sup>3</sup> /min	14	18	14/14.5	18/18.5
	Running current	Cooling	A	0.77	0.78	0.77	0.78
		Heating	A	-	-	0.77	0.78
	Power input	Cooling	Watt	145	150	145	150
		Heating	Watt	-	-	145	150
	Others	Connecting pipe	Liquid	mm	9.52	9.52	9.52
Gas			mm	15.88	15.88	15.88	15.88
Drain			mm	32	32	32	32
Size	Net weight		kg	28	28	28	28
	Shipping weight		kg	33	33	33	33
	Net dimension (WxHxD)		mm	1200x200x650	1200x200x650	1200x200x650	1200x200x650
	Shipping dimension(Carton/Case) (WxHxD)		mm	1350x350x980	1350x350x980	1350x350x980	1350x350x980
Function / Option	Auto restart		Yes/No	No	No	Yes	Yes
	Auto change over		Yes/No	No	No	No	No
	Centralized controller (On/Off)		Yes/No	Yes (Option)	Yes (Option)	Yes (Option)	Yes (Option)
	Group/Individual control from R/C		Yes/No	Yes (Option)	Yes (Option)	Yes (Option)	Yes (Option)
	Troubleshooting by L.E.D		Yes/No	Yes	Yes	Yes	Yes
	Auto swing (Up/Down)		Yes/No	Yes	Yes	Yes	Yes
	Max. installation ceiling height		mm	260	260	260	260
	Drain pump		Yes/No	Option	Option	Option	Option
	Certifications		-				

\* 1) Indoor temperature : 27°C DB, 19°C WB / Outdoor temperature : 35°C DB, 24°C WB / Piping length : 10m, difference : 0m

\* 2) Indoor temperature : 20°C DB / Outdoor temperature : 7°C DB, 6°C WB / Piping length : 10m, difference : 0m

\* 3) Actual noise level may differ, depending on the room structure, etc, since these noise values are from an anechoic room.

## (2) 60Hz

Model				AVMFC052CA0	AVMFC072CA0	AVMFH052CA0	AVMFH072CA0
Power supply			ø, V, Hz	1, 208 ~ 230, 60			
Remark				Cooling only		Heat pump	
Performance	Capacity	Cooling * 1)	Btu/h	18000	24000	18000	24000
			kW	5.2	7.2	5.2	7.2
		Heating * 2)	Btu/h	-	-	19000	26000
			kW	-	-	5.6	7.6
	Sound Level * 3)	Cooling (High/Low)	dB	43/40	45/40	43/40	45/40
Heating (High/Low)		dB	-	-	43/40	45/40	
Power	Fan output	Type	-	Cross fan	Cross fan	Cross fan	Cross fan
		Output	Watt	51	53	51	53
		Air flow rate	m <sup>3</sup> /min	14	18	14/14.5	18/18.5
	Running current	Cooling	A	0.77	0.78	0.77	0.78
		Heating	A	-	-	0.77	0.78
	Power input	Cooling	Watt	145	150	145	150
Heating		Watt	-	-	145	150	
Others	Connecting pipe	Liquid	mm	9.52	9.52	9.52	9.52
		Gas	mm	15.88	15.88	15.88	15.88
		Drain	mm	32	32	32	32
Size	Net weight		kg	28	28	28	28
	Shipping weight		kg	33	33	33	33
	Net dimension (WxHxD)		mm	1200x200x650	1200x200x650	1200x200x650	1200x200x650
	Shipping dimension(Carton/Case) (WxHxD)		mm	1350x350x980	1350x350x980	1350x350x980	1350x350x980
Function / Option	Auto restart		Yes/No	No	No	Yes	Yes
	Auto change over		Yes/No	No	No	No	No
	Centralized controller (On/Off)		Yes/No	Yes (Option)	Yes (Option)	Yes (Option)	Yes (Option)
	Group/Individual control from R/C		Yes/No	Yes (Option)	Yes (Option)	Yes (Option)	Yes (Option)
	Troubleshooting by L.E.D		Yes/No	Yes	Yes	Yes	Yes
	Auto swing (Up/Down)		Yes/No	Yes	Yes	Yes	Yes
	Max. installation ceiling height		mm	260	260	260	260
	Drain pump		Yes/No	Option	Option	Option	Option
	Certifications		-				

\* 1) Indoor temperature : 27°C DB, 19°C WB / Outdoor temperature : 35°C DB, 24°C WB / Piping length : 10m, difference : 0m

\* 2) Indoor temperature : 20°C DB / Outdoor temperature : 7°C DB, 6°C WB / Piping length : 10m, difference : 0m

\* 3) Actual noise level may differ, depending on the room structure, etc, since these noise values are from an anechoic room.



## 3. Functional parts and safety devices

### 3-1. 1-way cassette type

Item	Code	Name						
			AVMKC020EAO AVMKH020EAO AVMKC020CAO AVMKH020CAO	AVMKC026EAO AVMKH026EAO	AVMKC032CAO AVMKH032CAO	AVMKC035EAO AVMKH035EAO	AVMKC040CAO AVMKH040CAO	
Safety devices	Motor	Fan motor	model	PFS040WTVE	PFS040WTVE	PFS040WTVE	PFS040WTVEW	PFS040WTVE
			output	13W	14W	14W	16W	16W
		Safety thermostat	off	168°C	168°C	168°C	168°C	168°C
			on	-	-	-	-	-
Temperature sensor	EIS	Thermistor (heat exchanger inlet)	103AT (25°C=10kΩ)					
	EOS	Thermistor (heat exchanger outlet)	103AT (25°C=10kΩ)					
	ITAS	Thermistor (indoor temperature)	103AT (25°C=10kΩ)					
Functional parts	Electronic expansion valve kit	spec	0 - 460 step	0 - 460 step	0 - 460 step	0 - 460 step	0 - 460 step	
		model	AEV-14	AEV-14	AEV-14	AEV-14	AEV-14	
PCB Fuse			3.15A	3.15A	3.15A	3.15A	3.15A	

### 3-2. 4-way cassette type

Item	Code	Name						
			ABM1800B1	ABM2400B1	AVMCC052EAO AVMCH052EAO	AVMCC052CAO AVMCH052CAO	AVMCC070EAO AVMCH070EAO	
Safety devices	Motor	Fan motor	model	OSM516SAC	OSM516SAC	OSME506SAC	OSM516SAC	OSME506SAC
			output	51W	53W	51W	51W	53W
		Safety thermostat	off	150°C	150°C	150°C	150°C	150°C
			on	100°C	100°C	100°C	100°C	100°C
Temperature sensor	EIS	Thermistor (heat exchanger inlet)	103AT (25°C=10kΩ)					
	EOS	Thermistor (heat exchanger outlet)	103AT (25°C=10kΩ)					
	ITAS	Thermistor (indoor temperature)	103AT (25°C=10kΩ)					
Functional parts	Electronic expansion valve kit	spec	0 - 460 step	0 - 460 step	0 - 460 step	0 - 460 step	0 - 460 step	
		model	AEV-18	AEV-18	AEV-18	AEV-18	AEV-18	
PCB Fuse			3.15A	3.15A	3.15A	3.15A	3.15A	

Item	Code	Name				
			AVMCC072CAO AVMCH072CAO	AVMCC105EAO AVMCH105EAO	AVMCC105CAO AVMCH105CAO	
Safety devices	Motor	Fan motor	model	OSM516SAC	OSME1646SAC	OSM976SAC
			output	53W	84W	84W
		Safety thermostat	off	150°C	150°C	150°C
			on	100°C	100°C	100°C
Temperature sensor	EIS	Thermistor (heat exchanger inlet)	103AT (25°C=10kΩ)			
	EOS	Thermistor (heat exchanger outlet)	103AT (25°C=10kΩ)			
	ITAS	Thermistor (indoor temperature)	103AT (25°C=10kΩ)			
Functional parts	Electronic expansion valve kit	spec	0 - 460 step	0 - 460 step	0 - 460 step	
		model	AEV-18	AEV-24	AEV-24	
PCB Fuse			3.15A	3.15A	3.15A	

### 3-3. Duct type (Low silhouette)

Item	Code	Name	ADM1800B1	ADM2400B1	AVMDC052EA0 AVMDH052EA0	AVMDC052CA0 AVMDH052CA0	AVMDC070EA0 AVMDH070EA0	
			Safety devices	Motor	Fan motor	model	OSM956SAC	OSM1304SAC
output	51W	81W				51W	51W	81W
Safety thermostat	off	135°C			135°C	135°C	135°C	135°C
	on	90°C			90°C	90°C	90°C	90°C
Temperature sensor	EIS	Thermistor (heat exchanger inlet)	103AT (25°C=10kΩ)					
	EOS	Thermistor (heat exchanger outlet)	103AT (25°C=10kΩ)					
	ITAS	Thermistor (indoor temperature)	103AT (25°C=10kΩ)					
Functional parts	Electronic expansion valve kit	spec	0 ~ 460 step	0 ~ 460 step	0 ~ 460 step	0 ~ 460 step	0 ~ 460 step	
		model	AEV-18	AEV-18	AEV-18	AEV-18	AEV-18	
PCB Fuse			3.15A	3.15A	3.15A	3.15A	3.15A	

Item	Code	Name	AVMDC072CA0 AVMDH072CA0	
Safety devices	Motor	Fan motor	model	OSM1304SAC
			output	81W
		Safety thermostat	off	135°C
			on	90°C
Temperature sensor	EIS	Thermistor (heat exchanger inlet)	103AT (25°C=10kΩ)	
	EOS	Thermistor (heat exchanger outlet)	103AT (25°C=10kΩ)	
	ITAS	Thermistor (indoor temperature)	103AT (25°C=10kΩ)	
Functional parts	Electronic expansion valve kit	spec	0 ~ 460 step	
		model	AEV-18	
PCB Fuse			3.15A	



### 3. Functional parts and safety devices

#### 3-4. Duct type (Built-in)

Item	Code	Name		AVMBC020EA0	AVMBC020CA0	AVMBC026EA0	AVMBC032CA0	AVMBC035EA0
				AVMBH020EA0	AVMBH020CA0	AVMBH026EA0	AVMBH032CA0	AVMBH035EA0
Safety devices	Motor	Fan motor	model	OSME414SAC	OSM404SAC	OSME414SAC	OSM404SAC	OSME414SAC
			output	39W	39W	42W	42W	44W
		Safety thermostat	off	135°C	135°C	135°C	135°C	135°C
			on	90°C	90°C	90°C	90°C	90°C
Temperature sensor	EIS	Thermistor (heat exchanger inlet)	103AT (25°C=10kΩ)					
	EOS	Thermistor (heat exchanger outlet)	103AT (25°C=10kΩ)					
	ITAS	Thermistor (indoor temperature)	103AT (25°C=10kΩ)					
Functional parts	Electronic expansion valve kit	spec	0 ~ 460 step	0 ~ 460 step	0 ~ 460 step	0 ~ 460 step	0 ~ 460 step	
		model	AEV-14	AEV-14	AEV-14	AEV-14	AEV-14	
PCB Fuse			3.15A	3.15A	3.15A	3.15A	3.15A	

Item	Code	Name		AVMBC040CA0	AVMBC052EA0	AVMBC052CA0	AVMBC070EA0	AVMBC072CA0
				AVMBH040CA0	AVMBH052EA0	AVMBH052CA0	AVMBH070EA0	AVMBH072CA0
Safety devices	Motor	Fan motor	model	OSM404SAC	OSME974SAC	OSM966SAC	OSME974SAC	OSM966SAC
			output	44W	53W	53W	63W	63W
		Safety thermostat	off	135°C	135°C	135°C	135°C	135°C
			on	90°C	90°C	90°C	90°C	90°C
Temperature sensor	EIS	Thermistor (heat exchanger inlet)	103AT (25°C=10kΩ)					
	EOS	Thermistor (heat exchanger outlet)	103AT (25°C=10kΩ)					
	ITAS	Thermistor (indoor temperature)	103AT (25°C=10kΩ)					
Functional parts	Electronic expansion valve kit	spec	0 ~ 460 step	0 ~ 460 step	0 ~ 460 step	0 ~ 460 step	0 ~ 460 step	
		model	AEV-14	AEV-18	AEV-18	AEV-18	AEV-18	
PCB Fuse			3.15A	3.15A	3.15A	3.15A	3.15A	

#### 3-5. Duct type (High pressure)

Item	Code	Name		AVMHC105EA0	AVMHC105CA0	AVMHC128EA0	AVMHC128CA0
				AVMHH105EA0	AVMHH105CA0	AVMHH128EA0	AVMHH128CA0
Safety devices	Motor	Fan motor	model	OSME1604SAC	OSM1504SAC	OSME1604SAC	OSM1504SAC
			output	189W	193W	210W	214W
		Safety thermostat	off	150°C	150°C	150°C	150°C
			on	100°C	100°C	100°C	100°C
Temperature sensor	EIS	Thermistor (heat exchanger inlet)	103AT (25°C=10kΩ)				
	EOS	Thermistor (heat exchanger outlet)	103AT (25°C=10kΩ)				
	ITAS	Thermistor (indoor temperature)	103AT (25°C=10kΩ)				
Functional parts	Electronic expansion valve kit	spec	0 ~ 460 step	0 ~ 460 step	0 ~ 460 step	0 ~ 460 step	
		model	AEV-24	AEV-24	AEV-24	AEV-24	
PCB Fuse			5.00A	5.00A	5.00A	5.00A	



### 3-6. Wall-mounted type

Item	Code	Name	AVMWC020EA0 AVMWH020EA0 AVMWC020CA0 AVMWH020CA0					AVMWC026EA0 AVMWH026EA0		AVMWC032CA0 AVMWH032CA0		AVMWC035EA0 AVMWH035EA0		AVMWC040CA0 AVMWH040CA0	
			Safety devices	Motor	Fan motor	model	YFNPG22-4	YFNPG22-4	YFNPG22-4	YFNPG22-4	YFNPG22-4	YFNPG22-4	YFNPG22-4	YFNPG22-4	YFNPG22-4
output	13W	14W				14W	14W	16W	16W	16W	16W	16W	16W	16W	16W
Safety thermostat	off	168°C			168°C	168°C	168°C	168°C	168°C	168°C	168°C	168°C	168°C	168°C	168°C
	on	-			-	-	-	-	-	-	-	-	-	-	-
Temperature sensor	EIS	Thermistor (heat exchanger inlet)	103AT (25°C=10kΩ)												
	EOS	Thermistor (heat exchanger outlet)	103AT (25°C=10kΩ)												
	ITAS	Thermistor (indoor temperature)	103AT (25°C=10kΩ)												
Functional parts	Electronic expansion valve kit	spec	0 ~ 460 step	0 ~ 460 step	0 ~ 460 step	0 ~ 460 step	0 ~ 460 step	0 ~ 460 step	0 ~ 460 step	0 ~ 460 step	0 ~ 460 step	0 ~ 460 step	0 ~ 460 step	0 ~ 460 step	
		model	AEV-14	AEV-14	AEV-14	AEV-14	AEV-14	AEV-14	AEV-14	AEV-14	AEV-14	AEV-14	AEV-14	AEV-14	
PCB Fuse			3.15A	3.15A	3.15A	3.15A	3.15A	3.15A	3.15A	3.15A	3.15A	3.15A	3.15A		

Item	Code	Name	AVMWC052EA0 AVMWH052EA0 AVMWC052CA0 AVMWH052CA0			AVMWC070EA0 AVMWH070EA0		AVMWC072CA0 AVMWH072CA0	
			Safety devices	Motor	Fan motor	model	IC94350SKC7A	IC94350SKC7A	IC94350SKC7A
output	21W	21W				21W	21W	21W	
Safety thermostat	off	168°C			168°C	168°C	168°C	168°C	
	on	-			-	-	-	-	
Temperature sensor	EIS	Thermistor (heat exchanger inlet)	103AT (25°C=10kΩ)						
	EOS	Thermistor (heat exchanger outlet)	103AT (25°C=10kΩ)						
	ITAS	Thermistor (indoor temperature)	103AT (25°C=10kΩ)						
Functional parts	Electronic expansion valve kit	spec	0 ~ 460 step	0 ~ 460 step	0 ~ 460 step	0 ~ 460 step	0 ~ 460 step		
		model	AEV-18	AEV-18	AEV-18	AEV-18	AEV-18		
PCB Fuse			3.15A	3.15A	3.15A	3.15A	3.15A		



## 3. Functional parts and safety devices

### 3-7. Floor standing type

Item	Code	Name	AVMPC060EA0	AVMPC060CA0	AVMPC070EA0	AVMPC072CA0	AVMPC082EA0	
			AVMPH060EA0	AVMPH060CA0	AVMPH070EA0	AVMPH072CA0	AVMPH082EA0	
Safety devices	Motor	Fan motor	model	OSM1408SAC	OSM1308SAC	OSM1408SAC	OSM1308SAC	OSM1408SAC
			output	63W	63W	63W	63W	63W
		Safety thermostat	off	135°C	135°C	135°C	135°C	135°C
			on	90°C	90°C	90°C	90°C	90°C
Temperature sensor	EIS	Thermistor (heat exchanger inlet)	103AT (25°C=10kΩ)					
	EOS	Thermistor (heat exchanger outlet)	103AT (25°C=10kΩ)					
	ITAS	Thermistor (indoor temperature)	103AT (25°C=10kΩ)					
Functional parts	Electronic expansion valve kit	spec	0 ~ 460 step	0 ~ 460 step	0 ~ 460 step	0 ~ 460 step	0 ~ 460 step	
		model	AEV-18	AEV-18	AEV-18	AEV-18	AEV-18	
PCB Fuse			?	?	?	?	?	

Item	Code	Name	AVMPC083CA0 AVMPH083CA0				
Safety devices	Motor	Fan motor	model	OSM1308SAC			
			output	63W			
		Safety thermostat	off	135°C			
			on	90°C			
Temperature sensor	EIS	Thermistor (heat exchanger inlet)	103AT (25°C=10kΩ)				
	EOS	Thermistor (heat exchanger outlet)	103AT (25°C=10kΩ)				
	ITAS	Thermistor (indoor temperature)	103AT (25°C=10kΩ)				
Functional parts	Electronic expansion valve kit	spec	0 ~ 460 step				
		model	AEV-18				
PCB Fuse			?				

### 3-8. Ceiling type

Item	Code	Name	AVMFC052EA0	AVMFC052CA0	AVMFC070EA0	AVMFC072CA0	
			AVMFH052EA0	AVMFH052CA0	AVMFH070EA0	AVMFH072CA0	
Safety devices	Motor	Fan motor	model	?	?	?	?
			output	51W	51W	53W	53W
		Safety thermostat	off	135°C	135°C	135°C	135°C
			on	90°C	90°C	90°C	90°C
Temperature sensor	EIS	Thermistor (heat exchanger inlet)	103AT (25°C=10kΩ)				
	EOS	Thermistor (heat exchanger outlet)	103AT (25°C=10kΩ)				
	ITAS	Thermistor (indoor temperature)	103AT (25°C=10kΩ)				
Functional parts	Electronic expansion valve kit	spec	0 ~ 460 step	0 ~ 460 step	0 ~ 460 step	0 ~ 460 step	
		model	AEV-18	AEV-18	AEV-18	AEV-18	
PCB Fuse			?	?	?	?	

# 4. Capacity table

## 4-1. 50Hz

### (1) Cooling

TC : Total capacity

Unit Size	Outdoor temperature (°C, DB)	Indoor temperature (°C, WB)						
		14.0	16.0	18.0	19.0	20.0	22.0	24.0
		TC	TC	TC	TC	TC	TC	TC
		kW	kW	kW	kW	kW	kW	kW
020	10	1.46	1.73	2.05	2.16	2.30	2.56	2.83
	12	1.46	1.73	2.05	2.16	2.30	2.56	2.83
	14	1.46	1.73	2.05	2.16	2.30	2.56	2.83
	16	1.46	1.73	2.05	2.16	2.30	2.56	2.83
	18	1.46	1.73	2.05	2.16	2.30	2.56	2.83
	20	1.46	1.73	2.05	2.16	2.30	2.56	2.83
	21	1.46	1.73	2.05	2.16	2.30	2.56	2.83
	23	1.46	1.73	2.05	2.16	2.30	2.56	2.83
	25	1.46	1.73	2.05	2.16	2.27	2.53	2.75
	27	1.46	1.73	2.05	2.16	2.24	2.50	2.66
	29	1.46	1.73	2.05	2.08	2.21	2.44	2.59
	31	1.46	1.73	2.02	2.05	2.18	2.37	2.51
	33	1.46	1.73	1.97	2.03	2.15	2.30	2.43
	35	1.46	1.73	1.96	2.00	2.09	2.23	2.36
37	1.46	1.73	1.94	1.96	2.02	2.15	2.27	
39	1.46	1.70	1.91	1.93	1.94	2.07	2.19	
026	10	1.90	2.25	2.67	2.81	2.99	3.33	3.69
	12	1.90	2.25	2.67	2.81	2.99	3.33	3.69
	14	1.90	2.25	2.67	2.81	2.99	3.33	3.69
	16	1.90	2.25	2.67	2.81	2.99	3.33	3.69
	18	1.90	2.25	2.67	2.81	2.99	3.33	3.69
	20	1.90	2.25	2.67	2.81	2.99	3.33	3.69
	21	1.90	2.25	2.67	2.81	2.99	3.33	3.69
	23	1.90	2.25	2.67	2.81	2.99	3.33	3.67
	25	1.90	2.25	2.67	2.78	2.95	3.29	3.57
	27	1.90	2.25	2.67	2.74	2.91	3.25	3.46
	29	1.90	2.25	2.67	2.71	2.88	3.18	3.36
	31	1.90	2.25	2.62	2.67	2.84	3.08	3.26
	33	1.90	2.25	2.56	2.64	2.80	2.99	3.16
	35	1.90	2.25	2.55	2.60	2.72	2.90	3.06
37	1.90	2.25	2.52	2.55	2.63	2.79	2.96	
39	1.90	2.21	2.48	2.51	2.53	2.69	2.85	
035	10	2.56	3.02	3.60	3.79	4.02	4.49	4.96
	12	2.56	3.02	3.60	3.79	4.02	4.49	4.96
	14	2.56	3.02	3.60	3.79	4.02	4.49	4.96
	16	2.56	3.02	3.60	3.79	4.02	4.49	4.96
	18	2.56	3.02	3.60	3.79	4.02	4.49	4.96
	20	2.56	3.02	3.60	3.79	4.02	4.49	4.96
	21	2.56	3.02	3.60	3.79	4.02	4.49	4.96
	23	2.56	3.02	3.60	3.79	4.02	4.49	4.94
	25	2.56	3.02	3.60	3.74	3.97	4.43	4.81
	27	2.56	3.02	3.60	3.69	3.92	4.37	4.66
	29	2.56	3.02	3.60	3.64	3.87	4.28	4.53
	31	2.56	3.02	3.53	3.60	3.82	4.15	4.39
	33	2.56	3.02	3.45	3.55	3.77	4.02	4.26
	35	2.56	3.02	3.44	3.50	3.66	3.90	4.13
37	2.56	3.02	3.39	3.44	3.54	3.76	3.98	
39	2.56	2.98	3.34	3.37	3.40	3.62	3.83	



## 4. Capacity table

TC : Total capacity

Unit Size	Outdoor temperature (°C, DB)	Indoor temperature (°C, WB)						
		14.0	16.0	18.0	19.0	20.0	22.0	24.0
		TC	TC	TC	TC	TC	TC	TC
		kW	kW	kW	kW	kW	kW	kW
052	10	3.81	4.49	5.34	5.63	5.98	6.67	7.37
	12	3.81	4.49	5.34	5.63	5.98	6.67	7.37
	14	3.81	4.49	5.34	5.63	5.98	6.67	7.37
	16	3.81	4.49	5.34	5.63	5.98	6.67	7.37
	18	3.81	4.49	5.34	5.63	5.98	6.67	7.37
	20	3.81	4.49	5.34	5.63	5.98	6.67	7.37
	21	3.81	4.49	5.34	5.63	5.98	6.67	7.37
	23	3.81	4.49	5.34	5.63	5.98	6.67	7.35
	25	3.81	4.49	5.34	5.55	5.90	6.58	7.14
	27	3.81	4.49	5.34	5.48	5.83	6.50	6.93
	29	3.81	4.49	5.34	5.41	5.75	6.36	6.73
	31	3.81	4.49	5.25	5.34	5.68	6.16	6.52
	33	3.81	4.49	5.13	5.27	5.60	5.98	6.33
	35	3.81	4.49	5.11	5.20	5.44	5.79	6.13
	37	3.81	4.49	5.03	5.11	5.25	5.58	5.91
39	3.81	4.42	4.96	5.01	5.06	5.38	5.69	
070	10	5.12	6.05	7.19	7.57	8.05	8.98	9.92
	12	5.12	6.05	7.19	7.57	8.05	8.98	9.92
	14	5.12	6.05	7.19	7.57	8.05	8.98	9.92
	16	5.12	6.05	7.19	7.57	8.05	8.98	9.92
	18	5.12	6.05	7.19	7.57	8.05	8.98	9.92
	20	5.12	6.05	7.19	7.57	8.05	8.98	9.92
	21	5.12	6.05	7.19	7.57	8.05	8.98	9.92
	23	5.12	6.05	7.19	7.57	8.05	8.98	9.89
	25	5.12	6.05	7.19	7.48	7.94	8.86	9.61
	27	5.12	6.05	7.19	7.38	7.84	8.75	9.33
	29	5.12	6.05	7.19	7.29	7.74	8.55	9.06
	31	5.12	6.05	7.06	7.19	7.64	8.30	8.78
	33	5.12	6.05	6.90	7.10	7.54	8.05	8.52
	35	5.12	6.05	6.87	7.00	7.33	7.80	8.25
	37	5.12	6.05	6.78	6.87	7.07	7.52	7.96
39	5.12	5.95	6.68	6.75	6.81	7.24	7.66	

TC : Total capacity

Unit Size	Outdoor temperature (°C, DB)	Indoor temperature (°C, WB)						
		14.0	16.0	18.0	19.0	20.0	22.0	24.0
		TC	TC	TC	TC	TC	TC	TC
		kW	kW	kW	kW	kW	kW	kW
105	10	7.68	9.07	10.79	11.36	12.07	13.46	14.88
	12	7.68	9.07	10.79	11.36	12.07	13.46	14.88
	14	7.68	9.07	10.79	11.36	12.07	13.46	14.88
	16	7.68	9.07	10.79	11.36	12.07	13.46	14.88
	18	7.68	9.07	10.79	11.36	12.07	13.46	14.88
	20	7.68	9.07	10.79	11.36	12.07	13.46	14.88
	21	7.68	9.07	10.79	11.36	12.07	13.46	14.88
	23	7.68	9.07	10.79	11.36	12.07	13.46	14.83
	25	7.68	9.07	10.79	11.22	11.92	13.29	14.42
	27	7.68	9.07	10.79	11.07	11.76	13.12	13.99
	29	7.68	9.07	10.79	10.93	11.61	12.83	13.59
	31	7.68	9.07	10.60	10.79	11.46	12.45	13.17
	33	7.68	9.07	10.36	10.64	11.31	12.07	12.78
	35	7.68	9.07	10.31	10.50	10.99	11.70	12.38
37	7.68	9.07	10.17	10.31	10.61	11.28	11.94	
39	7.68	8.93	10.02	10.12	10.21	10.86	11.50	
128	10	9.37	11.05	13.15	13.85	14.71	16.41	18.14
	12	9.37	11.05	13.15	13.85	14.71	16.41	18.14
	14	9.37	11.05	13.15	13.85	14.71	16.41	18.14
	16	9.37	11.05	13.15	13.85	14.71	16.41	18.14
	18	9.37	11.05	13.15	13.85	14.71	16.41	18.14
	20	9.37	11.05	13.15	13.85	14.71	16.41	18.14
	21	9.37	11.05	13.15	13.85	14.71	16.41	18.14
	23	9.37	11.05	13.15	13.85	14.71	16.41	18.08
	25	9.37	11.05	13.15	13.67	14.53	16.21	17.58
	27	9.37	11.05	13.15	13.50	14.34	16.00	17.05
	29	9.37	11.05	13.15	13.32	14.16	15.64	16.57
	31	9.37	11.05	12.92	13.15	13.97	15.17	16.05
	33	9.37	11.05	12.63	12.97	13.79	14.71	15.58
	35	9.37	11.05	12.57	12.80	13.40	14.26	15.09
37	9.37	11.05	12.39	12.57	12.93	13.75	14.56	
39	9.37	10.88	12.22	12.33	12.44	13.24	14.01	



# 4. Capacity table

## (2) Heating

TC : Total capacity

Unit Size	Outdoor temperature (°C)		Indoor temperature (°C, DB)				
			16.0	18.0	20.0	22.0	24.0
	DB	WB	TC	TC	TC	TC	TC
			kW	kW	kW	kW	kW
020	-15	-14	1.45	1.43	1.40	1.39	1.36
	-12	-13	1.63	1.61	1.59	1.56	1.54
	-10	-11	1.83	1.78	1.74	1.72	1.69
	-7	-8	1.98	1.94	1.87	1.83	1.78
	-5	-6	2.13	2.05	1.98	1.94	1.89
	-3	-4	2.24	2.16	2.08	2.02	1.89
	0	-1	2.33	2.24	2.20	2.02	1.89
	3	2.2	2.38	2.33	2.20	2.02	1.89
	5	4.1	2.46	2.38	2.20	2.02	1.89
	7	6	2.53	2.38	2.20	2.02	1.89
	9	7.9	2.57	2.38	2.20	2.02	1.89
	11	9.8	2.57	2.38	2.20	2.02	1.89
	13	12	2.57	2.38	2.20	2.02	1.89
026	-15	-14	1.91	1.89	1.85	1.83	1.80
	-12	-13	2.15	2.12	2.10	2.06	2.03
	-10	-11	2.41	2.35	2.29	2.26	2.23
	-7	-8	2.61	2.55	2.47	2.41	2.35
	-5	-6	2.81	2.70	2.61	2.55	2.49
	-3	-4	2.96	2.84	2.74	2.67	2.49
	0	-1	3.07	2.96	2.90	2.67	2.49
	3	2.2	3.13	3.07	2.90	2.67	2.49
	5	4.1	3.25	3.13	2.90	2.67	2.49
	7	6	3.34	3.13	2.90	2.67	2.49
	9	7.9	3.39	3.13	2.90	2.67	2.49
	11	9.8	3.39	3.13	2.90	2.67	2.49
	13	12	3.39	3.13	2.90	2.67	2.49
035	-15	-14	2.5	2.5	2.4	2.4	2.4
	-12	-13	2.8	2.8	2.7	2.7	2.7
	-10	-11	3.2	3.1	3.0	3.0	2.9
	-7	-8	3.4	3.3	3.2	3.2	3.1
	-5	-6	3.7	3.5	3.4	3.3	3.3
	-3	-4	3.9	3.7	3.6	3.5	3.3
	0	-1	4.0	3.9	3.8	3.5	3.3
	3	2.2	4.1	4.0	3.8	3.5	3.3
	5	4.1	4.3	4.1	3.8	3.5	3.3
	7	6	4.4	4.1	3.8	3.5	3.3
	9	7.9	4.4	4.1	3.8	3.5	3.3
	11	9.8	4.4	4.1	3.8	3.5	3.3
	13	12	4.4	4.1	3.8	3.5	3.3
15	14	4.4	4.1	3.8	3.5	3.3	

TC : Total capacity

Unit Size	Outdoor temperature (°C)		Indoor temperature (°C, DB)				
			16.0	18.0	20.0	22.0	24.0
	DB	WB	TC	TC	TC	TC	TC
052	-15	-14	3.7	3.6	3.6	3.5	3.5
	-12	-13	4.1	4.1	4.0	4.0	3.9
	-10	-11	4.6	4.5	4.4	4.4	4.3
	-7	-8	5.0	4.9	4.8	4.6	4.5
	-5	-6	5.4	5.2	5.0	4.9	4.8
	-3	-4	5.7	5.5	5.3	5.2	4.8
	0	-1	5.9	5.7	5.6	5.2	4.8
	3	2.2	6.0	5.9	5.6	5.2	4.8
	5	4.1	6.3	6.0	5.6	5.2	4.8
	7	6	6.4	6.0	5.6	5.2	4.8
	9	7.9	6.6	6.0	5.6	5.2	4.8
	11	9.8	6.6	6.0	5.6	5.2	4.8
	13	12	6.6	6.0	5.6	5.2	4.8
070	-15	-14	5.0	4.9	4.8	4.8	4.7
	-12	-13	5.6	5.5	5.5	5.4	5.3
	-10	-11	6.3	6.2	6.0	5.9	5.9
	-7	-8	6.8	6.7	6.5	6.3	6.2
	-5	-6	7.4	7.1	6.8	6.7	6.5
	-3	-4	7.8	7.4	7.2	7.0	6.5
	0	-1	8.1	7.8	7.6	7.0	6.5
	3	2.2	8.2	8.1	7.6	7.0	6.5
	5	4.1	8.5	8.2	7.6	7.0	6.5
	7	6	8.7	8.2	7.6	7.0	6.5
	9	7.9	8.9	8.2	7.6	7.0	6.5
	11	9.8	8.9	8.2	7.6	7.0	6.5
	13	12	8.9	8.2	7.6	7.0	6.5
15	14	8.9	8.2	7.6	7.0	6.5	
105	-15	-14	7.5	7.4	7.3	7.2	7.1
	-12	-13	8.4	8.3	8.2	8.1	8.0
	-10	-11	9.5	9.2	9.0	8.9	8.8
	-7	-8	10.3	10.0	9.7	9.5	9.2
	-5	-6	11.1	10.6	10.2	10.0	9.8
	-3	-4	11.6	11.2	10.8	10.5	9.8
	0	-1	12.1	11.6	11.4	10.5	9.8
	3	2.2	12.3	12.1	11.4	10.5	9.8
	5	4.1	12.8	12.3	11.4	10.5	9.8
	7	6	13.1	12.3	11.4	10.5	9.8
	9	7.9	13.3	12.3	11.4	10.5	9.8
	11	9.8	13.3	12.3	11.4	10.5	9.8
	13	12	13.3	12.3	11.4	10.5	9.8
15	14	13.3	12.3	11.4	10.5	9.8	



## 4. Capacity table

TC : Total capacity

Unit Size	Outdoor temperature (°C)		Indoor temperature (°C, DB)				
			16.0	18.0	20.0	22.0	24.0
	DB	WB	TC	TC	TC	TC	TC
128	-15	-14	9.1	9.0	8.8	8.7	8.6
	-12	-13	10.2	10.1	10.0	9.8	9.7
	-10	-11	11.5	11.2	10.9	10.8	10.6
	-7	-8	12.4	12.1	11.8	11.5	11.2
	-5	-6	13.4	12.8	12.4	12.1	11.9
	-3	-4	14.1	13.5	13.0	12.7	11.9
	0	-1	14.6	14.1	13.8	12.7	11.9
	3	2.2	14.9	14.6	13.8	12.7	11.9
	5	4.1	15.5	14.9	13.8	12.7	11.9
	7	6	15.9	14.9	13.8	12.7	11.9
	9	7.9	16.1	14.9	13.8	12.7	11.9
	11	9.8	16.1	14.9	13.8	12.7	11.9
	13	12	16.1	14.9	13.8	12.7	11.9
15	14	16.1	14.9	13.8	12.7	11.9	



## 4-2. 60Hz

### (1) Cooling

TC : Total capacity

Unit Size	Outdoor temperature (°C, WB)	Indoor temperature (°C, WB)						
		14.0	16.0	18.0	19.0	20.0	22.0	24.0
		TC	TC	TC	TC	TC	TC	TC
		kW	kW	kW	kW	kW	kW	kW
020	10	1.46	1.73	2.05	2.16	2.30	2.56	2.83
	12	1.46	1.73	2.05	2.16	2.30	2.56	2.83
	14	1.46	1.73	2.05	2.16	2.30	2.56	2.83
	16	1.46	1.73	2.05	2.16	2.30	2.56	2.83
	18	1.46	1.73	2.05	2.16	2.30	2.56	2.83
	20	1.46	1.73	2.05	2.16	2.30	2.56	2.83
	21	1.46	1.73	2.05	2.16	2.30	2.56	2.83
	23	1.46	1.73	2.05	2.16	2.30	2.56	2.83
	25	1.46	1.73	2.05	2.14	2.27	2.53	2.75
	27	1.46	1.73	2.05	2.11	2.24	2.50	2.66
	29	1.46	1.73	2.05	2.08	2.21	2.44	2.59
	31	1.46	1.73	2.02	2.05	2.18	2.37	2.51
	33	1.46	1.73	1.97	2.03	2.15	2.30	2.43
	35	1.46	1.73	1.96	2.00	2.09	2.23	2.36
37	1.46	1.73	1.94	1.96	2.02	2.15	2.27	
39	1.46	1.70	1.91	1.93	1.94	2.07	2.19	
032	10	2.34	2.76	3.29	3.46	3.68	4.10	4.54
	12	2.34	2.76	3.29	3.46	3.68	4.10	4.54
	14	2.34	2.76	3.29	3.46	3.68	4.10	4.54
	16	2.34	2.76	3.29	3.46	3.68	4.10	4.54
	18	2.34	2.76	3.29	3.46	3.68	4.10	4.54
	20	2.34	2.76	3.29	3.46	3.68	4.10	4.54
	21	2.34	2.76	3.29	3.46	3.68	4.10	4.54
	23	2.34	2.76	3.29	3.46	3.68	4.10	4.52
	25	2.34	2.76	3.29	3.42	3.63	4.05	4.39
	27	2.34	2.76	3.29	3.37	3.59	4.00	4.26
	29	2.34	2.76	3.29	3.33	3.54	3.91	4.14
	31	2.34	2.76	3.23	3.29	3.49	3.79	4.01
	33	2.34	2.76	3.16	3.24	3.45	3.68	3.90
	35	2.34	2.76	3.14	3.20	3.35	3.56	3.77
37	2.34	2.76	3.10	3.14	3.23	3.44	3.64	
39	2.34	2.72	3.05	3.08	3.11	3.31	3.50	
040	10	2.93	3.45	4.11	4.33	4.60	5.13	5.67
	12	2.93	3.45	4.11	4.33	4.60	5.13	5.67
	14	2.93	3.45	4.11	4.33	4.60	5.13	5.67
	16	2.93	3.45	4.11	4.33	4.60	5.13	5.67
	18	2.93	3.45	4.11	4.33	4.60	5.13	5.67
	20	2.93	3.45	4.11	4.33	4.60	5.13	5.67
	21	2.93	3.45	4.11	4.33	4.60	5.13	5.67
	23	2.93	3.45	4.11	4.33	4.60	5.13	5.65
	25	2.93	3.45	4.11	4.27	4.54	5.06	5.49
	27	2.93	3.45	4.11	4.22	4.48	5.00	5.33
	29	2.93	3.45	4.11	4.16	4.42	4.89	5.18
	31	2.93	3.45	4.04	4.11	4.37	4.74	5.02
	33	2.93	3.45	3.95	4.05	4.31	4.60	4.87
	35	2.93	3.45	3.93	4.00	4.19	4.46	4.71
37	2.93	3.45	3.87	3.93	4.04	4.30	4.55	
39	2.93	3.40	3.82	3.85	3.89	4.14	4.38	



# 4. Capacity table

TC : Total capacity

Unit Size	Outdoor temperature (°C, WB)	Indoor temperature (°C, WB)						
		14.0	16.0	18.0	19.0	20.0	22.0	24.0
		TC	TC	TC	TC	TC	TC	TC
		kW	kW	kW	kW	kW	kW	kW
052	10	3.81	4.49	5.34	5.63	5.98	6.67	7.37
	12	3.81	4.49	5.34	5.63	5.98	6.67	7.37
	14	3.81	4.49	5.34	5.63	5.98	6.67	7.37
	16	3.81	4.49	5.34	5.63	5.98	6.67	7.37
	18	3.81	4.49	5.34	5.63	5.98	6.67	7.37
	20	3.81	4.49	5.34	5.63	5.98	6.67	7.37
	21	3.81	4.49	5.34	5.63	5.98	6.67	7.37
	23	3.81	4.49	5.34	5.63	5.98	6.67	7.35
	25	3.81	4.49	5.34	5.55	5.90	6.58	7.14
	27	3.81	4.49	5.34	5.48	5.83	6.50	6.93
	29	3.81	4.49	5.34	5.41	5.75	6.36	6.73
	31	3.81	4.49	5.25	5.34	5.68	6.16	6.52
	33	3.81	4.49	5.13	5.27	5.60	5.98	6.33
	35	3.81	4.49	5.11	5.20	5.44	5.79	6.13
37	3.81	4.49	5.03	5.11	5.25	5.58	5.91	
39	3.81	4.42	4.96	5.01	5.06	5.38	5.69	
072	10	5.27	6.22	7.40	7.79	8.28	9.23	10.21
	12	5.27	6.22	7.40	7.79	8.28	9.23	10.21
	14	5.27	6.22	7.40	7.79	8.28	9.23	10.21
	16	5.27	6.22	7.40	7.79	8.28	9.23	10.21
	18	5.27	6.22	7.40	7.79	8.28	9.23	10.21
	20	5.27	6.22	7.40	7.79	8.28	9.23	10.21
	21	5.27	6.22	7.40	7.79	8.28	9.23	10.21
	23	5.27	6.22	7.40	7.79	8.28	9.23	10.17
	25	5.27	6.22	7.40	7.69	8.17	9.12	9.89
	27	5.27	6.22	7.40	7.59	8.07	9.00	9.59
	29	5.27	6.22	7.40	7.49	7.96	8.80	9.32
	31	5.27	6.22	7.27	7.40	7.86	8.54	9.03
	33	5.27	6.22	7.10	7.30	7.75	8.28	8.76
	35	5.27	6.22	7.07	7.20	7.54	8.02	8.49
37	5.27	6.22	6.97	7.07	7.27	7.73	8.19	
39	5.27	6.12	6.87	6.94	7.00	7.45	7.88	
083	10	6.07	7.17	8.53	8.98	9.54	10.64	11.77
	12	6.07	7.17	8.53	8.98	9.54	10.64	11.77
	14	6.07	7.17	8.53	8.98	9.54	10.64	11.77
	16	6.07	7.17	8.53	8.98	9.54	10.64	11.77
	18	6.07	7.17	8.53	8.98	9.54	10.64	11.77
	20	6.07	7.17	8.53	8.98	9.54	10.64	11.77
	21	6.07	7.17	8.53	8.98	9.54	10.64	11.77
	23	6.07	7.17	8.53	8.98	9.54	10.64	11.72
	25	6.07	7.17	8.53	8.87	9.42	10.51	11.40
	27	6.07	7.17	8.53	8.75	9.30	10.37	11.06
	29	6.07	7.17	8.53	8.64	9.18	10.14	10.74
	31	6.07	7.17	8.38	8.53	9.06	9.84	10.41
	33	6.07	7.17	8.19	8.41	8.94	9.54	10.10
	35	6.07	7.17	8.15	8.30	8.69	9.24	9.78
37	6.07	7.17	8.04	8.15	8.39	8.91	9.44	
39	6.07	7.06	7.92	8.00	8.07	8.59	9.09	

TC : Total capacity

Unit Size	Outdoor temperature (°C, WB)	Indoor temperature (°C, WB)						
		14.0	16.0	18.0	19.0	20.0	22.0	24.0
		TC	TC	TC	TC	TC	TC	TC
		kW	kW	kW	kW	kW	kW	kW
105	10	7.7	9.1	10.8	11.4	12.1	13.5	14.9
	12	7.7	9.1	10.8	11.4	12.1	13.5	14.9
	14	7.7	9.1	10.8	11.4	12.1	13.5	14.9
	16	7.7	9.1	10.8	11.4	12.1	13.5	14.9
	18	7.7	9.1	10.8	11.4	12.1	13.5	14.9
	20	7.7	9.1	10.8	11.4	12.1	13.5	14.9
	21	7.7	9.1	10.8	11.4	12.1	13.5	14.9
	23	7.7	9.1	10.8	11.4	12.1	13.5	14.8
	25	7.7	9.1	10.8	11.2	11.9	13.3	14.4
	27	7.7	9.1	10.8	11.1	11.8	13.1	14.0
	29	7.7	9.1	10.8	10.9	11.6	12.8	13.6
	31	7.7	9.1	10.6	10.8	11.5	12.4	13.2
	33	7.7	9.1	10.4	10.6	11.3	12.1	12.8
	35	7.7	9.1	10.3	10.5	11.0	11.7	12.4
37	7.7	9.1	10.2	10.3	10.6	11.3	11.9	
39	7.7	8.9	10.0	10.1	10.2	10.9	11.5	
128	10	9.37	11.05	13.15	13.85	14.71	16.41	18.14
	12	9.37	11.05	13.15	13.85	14.71	16.41	18.14
	14	9.37	11.05	13.15	13.85	14.71	16.41	18.14
	16	9.37	11.05	13.15	13.85	14.71	16.41	18.14
	18	9.37	11.05	13.15	13.85	14.71	16.41	18.14
	20	9.37	11.05	13.15	13.85	14.71	16.41	18.14
	21	9.37	11.05	13.15	13.85	14.71	16.41	18.14
	23	9.37	11.05	13.15	13.85	14.71	16.41	18.08
	25	9.37	11.05	13.15	13.67	14.53	16.21	17.58
	27	9.37	11.05	13.15	13.50	14.34	16.00	17.05
	29	9.37	11.05	13.15	13.32	14.16	15.64	16.57
	31	9.37	11.05	12.92	13.15	13.97	15.17	16.05
	33	9.37	11.05	12.63	12.97	13.79	14.71	15.58
	35	9.37	11.05	12.57	12.80	13.40	14.26	15.09
37	9.37	11.05	12.39	12.57	12.93	13.75	14.56	
39	9.37	10.88	12.22	12.33	12.44	13.24	14.01	



# 4. Capacity table

## (2) Heating

TC : Total capacity

Unit Size	Outdoor temperature (°C)		Indoor temperature (°C, DB)				
			16.0	18.0	20.0	22.0	24.0
	DB	WB	TC	TC	TC	TC	TC
			kW	kW	kW	kW	kW
020	-15	-14	1.45	1.43	1.40	1.39	1.36
	-12	-13	1.63	1.61	1.59	1.56	1.54
	-10	-11	1.83	1.78	1.74	1.72	1.69
	-7	-8	1.98	1.94	1.87	1.83	1.78
	-5	-6	2.13	2.05	1.98	1.94	1.89
	-3	-4	2.24	2.16	2.08	2.02	1.89
	0	-1	2.33	2.24	2.20	2.02	1.89
	3	2.2	2.38	2.33	2.20	2.02	1.89
	5	4.1	2.46	2.38	2.20	2.02	1.89
	7	6	2.53	2.38	2.20	2.02	1.89
	9	7.9	2.57	2.38	2.20	2.02	1.89
	11	9.8	2.57	2.38	2.20	2.02	1.89
	13	12	2.57	2.38	2.20	2.02	1.89
032	-15	-14	2.31	2.28	2.23	2.21	2.17
	-12	-13	2.59	2.56	2.53	2.49	2.45
	-10	-11	2.91	2.84	2.76	2.73	2.70
	-7	-8	3.15	3.08	2.98	2.91	2.84
	-5	-6	3.40	3.26	3.14	3.08	3.01
	-3	-4	3.57	3.43	3.31	3.22	3.01
	0	-1	3.71	3.57	3.50	3.22	3.01
	3	2.2	3.78	3.71	3.50	3.22	3.01
	5	4.1	3.92	3.78	3.50	3.22	3.01
	7	6	4.03	3.78	3.50	3.22	3.01
	9	7.9	4.10	3.78	3.50	3.22	3.01
	11	9.8	4.10	3.78	3.50	3.22	3.01
	13	12	4.10	3.78	3.50	3.22	3.01
040	-15	-14	2.8	2.8	2.7	2.7	2.7
	-12	-13	3.2	3.1	3.1	3.1	3.0
	-10	-11	3.6	3.5	3.4	3.4	3.3
	-7	-8	3.9	3.8	3.7	3.6	3.5
	-5	-6	4.2	4.0	3.9	3.8	3.7
	-3	-4	4.4	4.2	4.1	4.0	3.7
	0	-1	4.6	4.4	4.3	4.0	3.7
	3	2.2	4.6	4.6	4.3	4.0	3.7
	5	4.1	4.8	4.6	4.3	4.0	3.7
	7	6	4.9	4.6	4.3	4.0	3.7
	9	7.9	5.0	4.6	4.3	4.0	3.7
	11	9.8	5.0	4.6	4.3	4.0	3.7
	13	12	5.0	4.6	4.3	4.0	3.7
15	14	5.0	4.6	4.3	4.0	3.7	

TC : Total capacity

Unit Size	Outdoor temperature (°C)		Indoor temperature (°C, DB)				
			16.0	18.0	20.0	22.0	24.0
	DB	WB	TC	TC	TC	TC	TC
052	-15	-14	3.7	3.6	3.6	3.5	3.5
	-12	-13	4.1	4.1	4.0	4.0	3.9
	-10	-11	4.6	4.5	4.4	4.4	4.3
	-7	-8	5.0	4.9	4.8	4.6	4.5
	-5	-6	5.4	5.2	5.0	4.9	4.8
	-3	-4	5.7	5.5	5.3	5.2	4.8
	0	-1	5.9	5.7	5.6	5.2	4.8
	3	2.2	6.0	5.9	5.6	5.2	4.8
	5	4.1	6.3	6.0	5.6	5.2	4.8
	7	6	6.4	6.0	5.6	5.2	4.8
	9	7.9	6.6	6.0	5.6	5.2	4.8
	11	9.8	6.6	6.0	5.6	5.2	4.8
	13	12	6.6	6.0	5.6	5.2	4.8
072	-15	-14	5.0	4.9	4.8	4.8	4.7
	-12	-13	5.6	5.5	5.5	5.4	5.3
	-10	-11	6.3	6.2	6.0	5.9	5.9
	-7	-8	6.8	6.7	6.5	6.3	6.2
	-5	-6	7.4	7.1	6.8	6.7	6.5
	-3	-4	7.8	7.4	7.2	7.0	6.5
	0	-1	8.1	7.8	7.6	7.0	6.5
	3	2.2	8.2	8.1	7.6	7.0	6.5
	5	4.1	8.5	8.2	7.6	7.0	6.5
	7	6	8.7	8.2	7.6	7.0	6.5
	9	7.9	8.9	8.2	7.6	7.0	6.5
	11	9.8	8.9	8.2	7.6	7.0	6.5
	13	12	8.9	8.2	7.6	7.0	6.5
15	14	8.9	8.2	7.6	7.0	6.5	
105	-15	-14	7.5	7.4	7.3	7.2	7.1
	-12	-13	8.4	8.3	8.2	8.1	8.0
	-10	-11	9.5	9.2	9.0	8.9	8.8
	-7	-8	10.3	10.0	9.7	9.5	9.2
	-5	-6	11.1	10.6	10.2	10.0	9.8
	-3	-4	11.6	11.2	10.8	10.5	9.8
	0	-1	12.1	11.6	11.4	10.5	9.8
	3	2.2	12.3	12.1	11.4	10.5	9.8
	5	4.1	12.8	12.3	11.4	10.5	9.8
	7	6	13.1	12.3	11.4	10.5	9.8
	9	7.9	13.3	12.3	11.4	10.5	9.8
	11	9.8	13.3	12.3	11.4	10.5	9.8
	13	12	13.3	12.3	11.4	10.5	9.8
15	14	13.3	12.3	11.4	10.5	9.8	



## 4. Capacity table

TC : Total capacity

Unit Size	Outdoor temperature (°C)		Indoor temperature (°C, DB)				
			16.0	18.0	20.0	22.0	24.0
	DB	WB	TC	TC	TC	TC	TC
128			kW	kW	kW	kW	kW
	-15	-14	9.1	9.0	8.8	8.7	8.6
	-12	-13	10.2	10.1	10.0	9.8	9.7
	-10	-11	11.5	11.2	10.9	10.8	10.6
	-7	-8	12.4	12.1	11.8	11.5	11.2
	-5	-6	13.4	12.8	12.4	12.1	11.9
	-3	-4	14.1	13.5	13.0	12.7	11.9
	0	-1	14.6	14.1	13.8	12.7	11.9
	3	2.2	14.9	14.6	13.8	12.7	11.9
	5	4.1	15.5	14.9	13.8	12.7	11.9
	7	6	15.9	14.9	13.8	12.7	11.9
	9	7.9	16.1	14.9	13.8	12.7	11.9
	11	9.8	16.1	14.9	13.8	12.7	11.9
13	12	16.1	14.9	13.8	12.7	11.9	
15	14	16.1	14.9	13.8	12.7	11.9	

# 5. Dimension

## 5-1. 1-way cassette type

Unit : mm

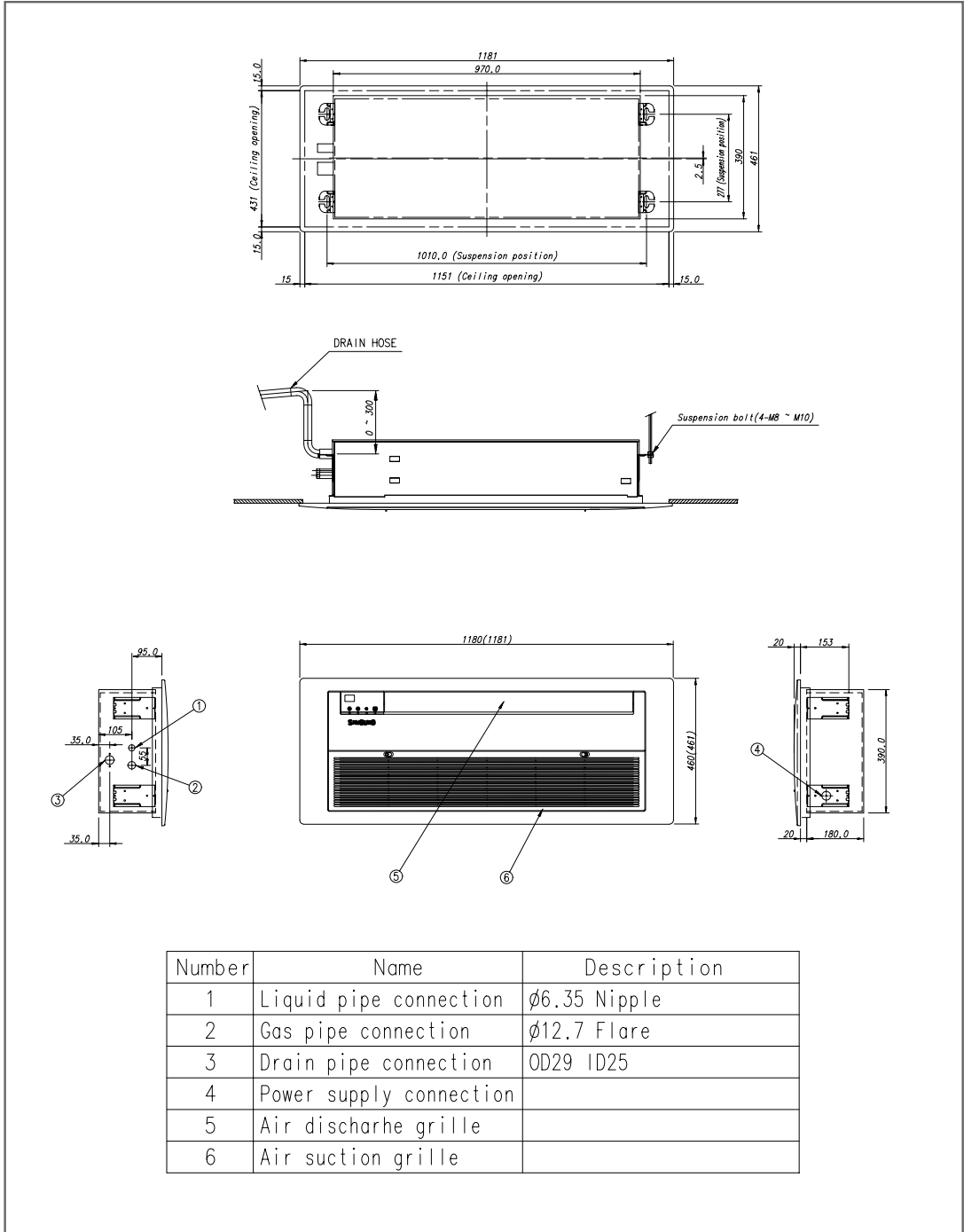

- ◆ Check the position of remote control sensor and indicators before installing the unit.
- ◆ If you want to install optional parts, refer to an appropriate installation manual.



# 5. Dimension

## 5-2. 4-way cassette type

### (1) 5.2kW ~ 7.2kW

Unit : mm

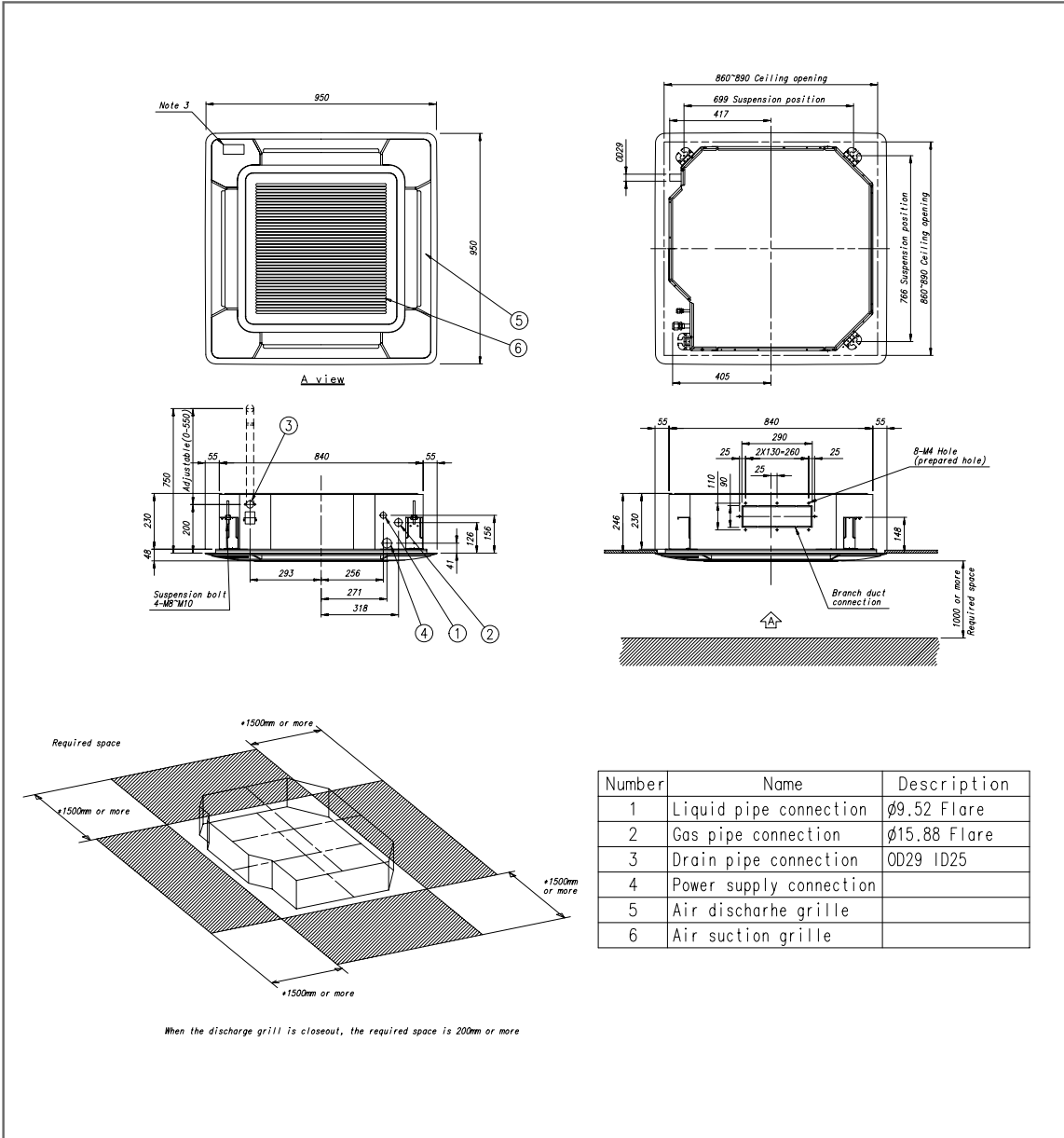

Number	Name	Description
1	Liquid pipe connection	φ9.52 Flare
2	Gas pipe connection	φ15.88 Flare
3	Drain pipe connection	OD29 ID25
4	Power supply connection	
5	Air discharge grille	
6	Air suction grille	



- ◆ Check the position of remote control sensor and indicators before installing the unit.
- ◆ If you want to install optional parts, refer to an appropriate installation manual.



(2) 10.5kW

Unit : mm

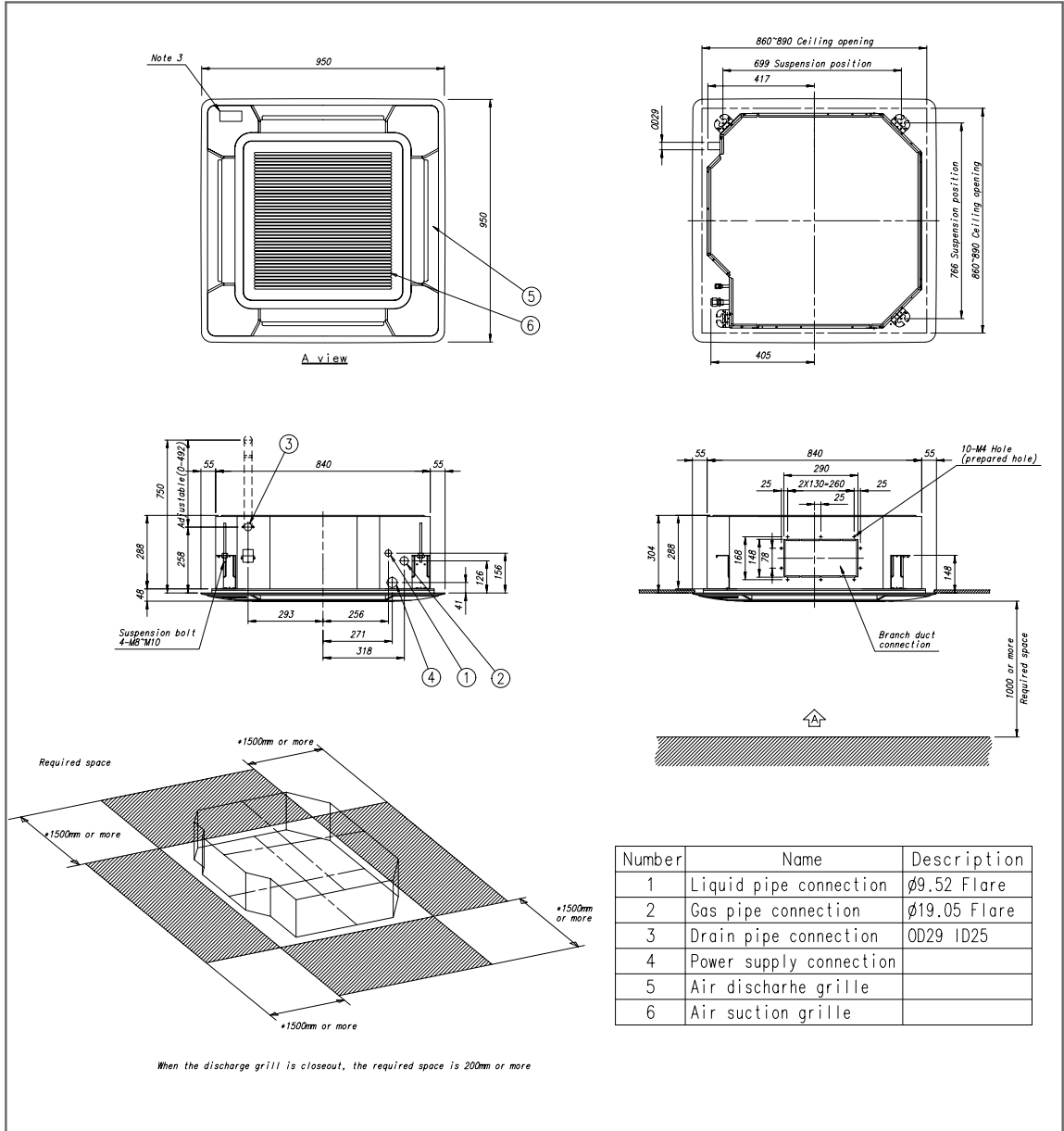

Number	Name	Description
1	Liquid pipe connection	ø9.52 Flare
2	Gas pipe connection	ø19.05 Flare
3	Drain pipe connection	OD29 ID25
4	Power supply connection	
5	Air discharge grille	
6	Air suction grille	

- Caution**
- ◆ Check the position of remote control sensor and indicators before installing the unit.
  - ◆ If you want to install optional parts, refer to an appropriate installation manual.



# 5. Dimension

## 5-3. Duct type (Low silhouette)

Unit : mm

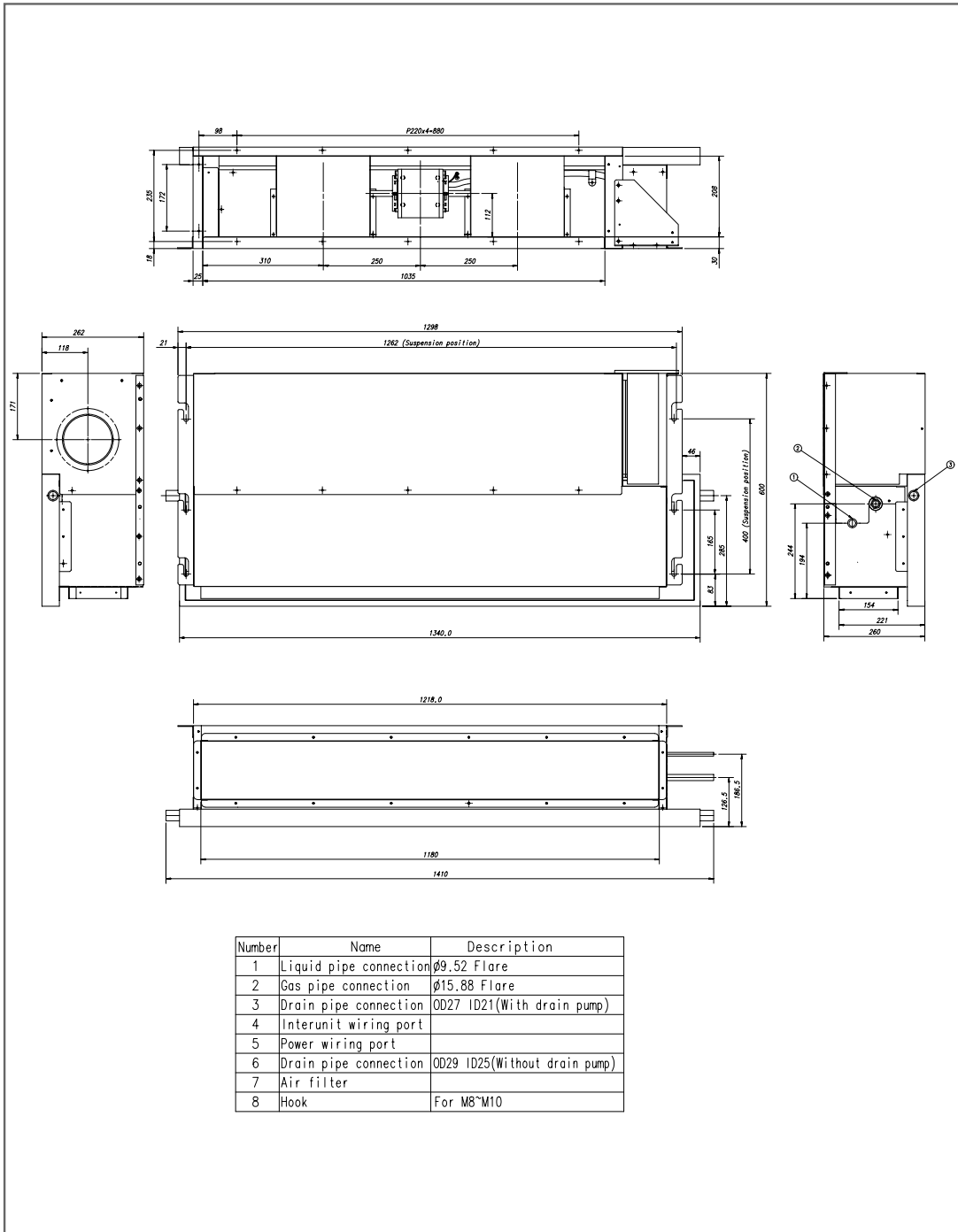

◆ If you want to install optional parts, refer to an appropriate installation manual.

## 5-4. Duct type (Built-in)

### (1) 2.0kW ~ 4.0kW

Unit : mm

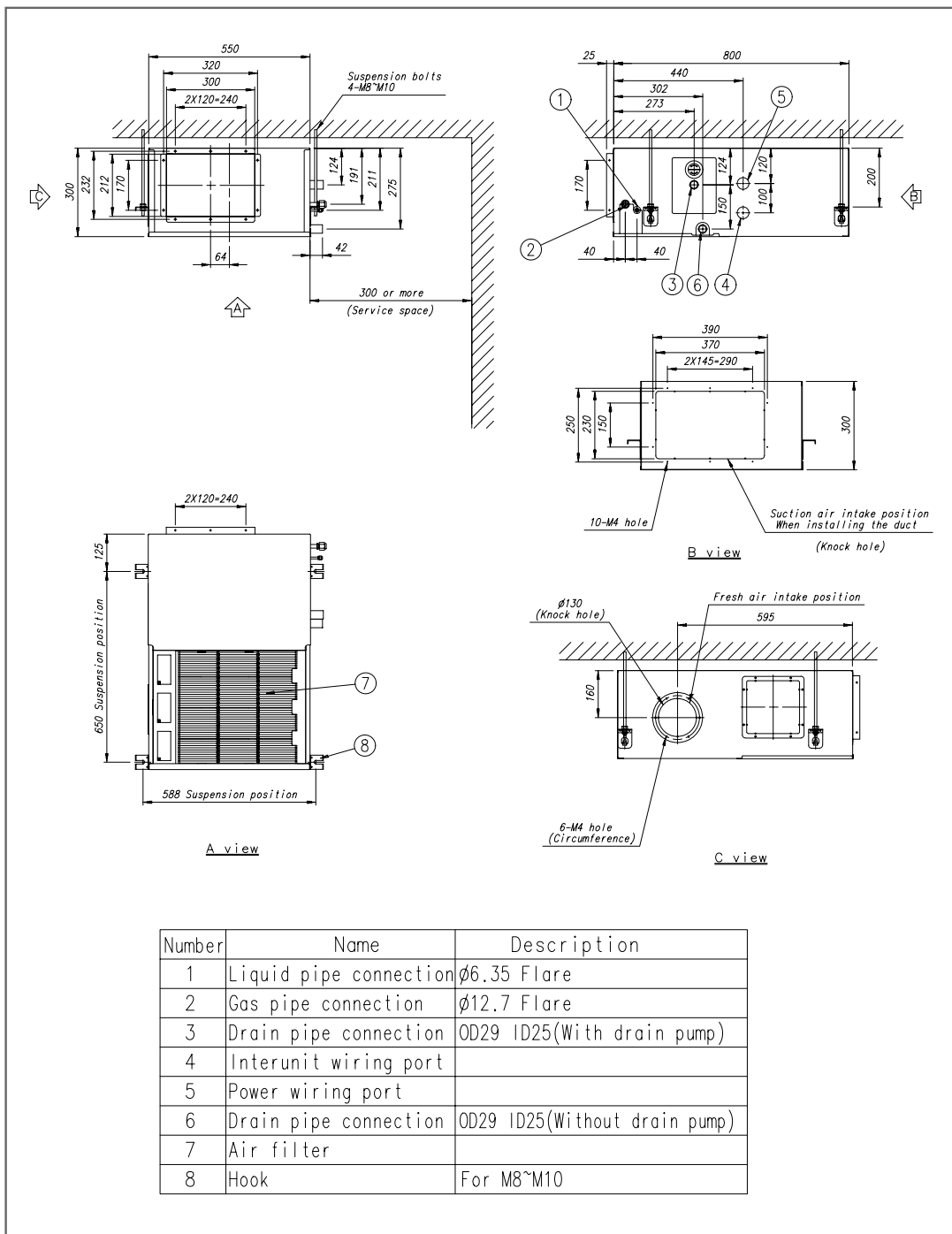

⚠ Caution ⚠ ◆ If you want to install optional parts, refer to an appropriate installation manual.



# 5. Dimension

(2) 5.2kW ~ 7.2kW

Unit : mm

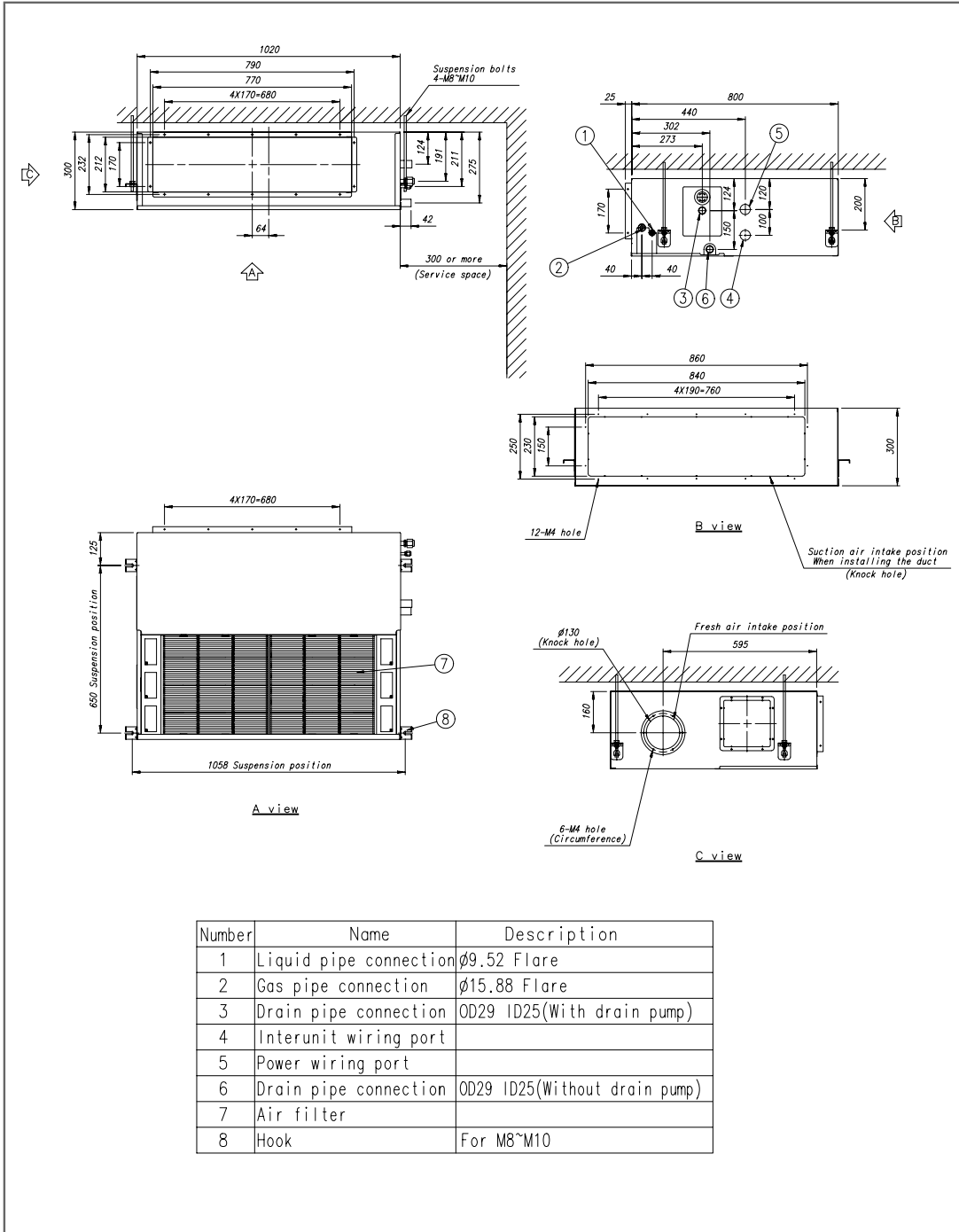

◆ If you want to install optional parts, refer to an appropriate installation manual.

## 5-5. Duct type (High pressure)

Unit : mm

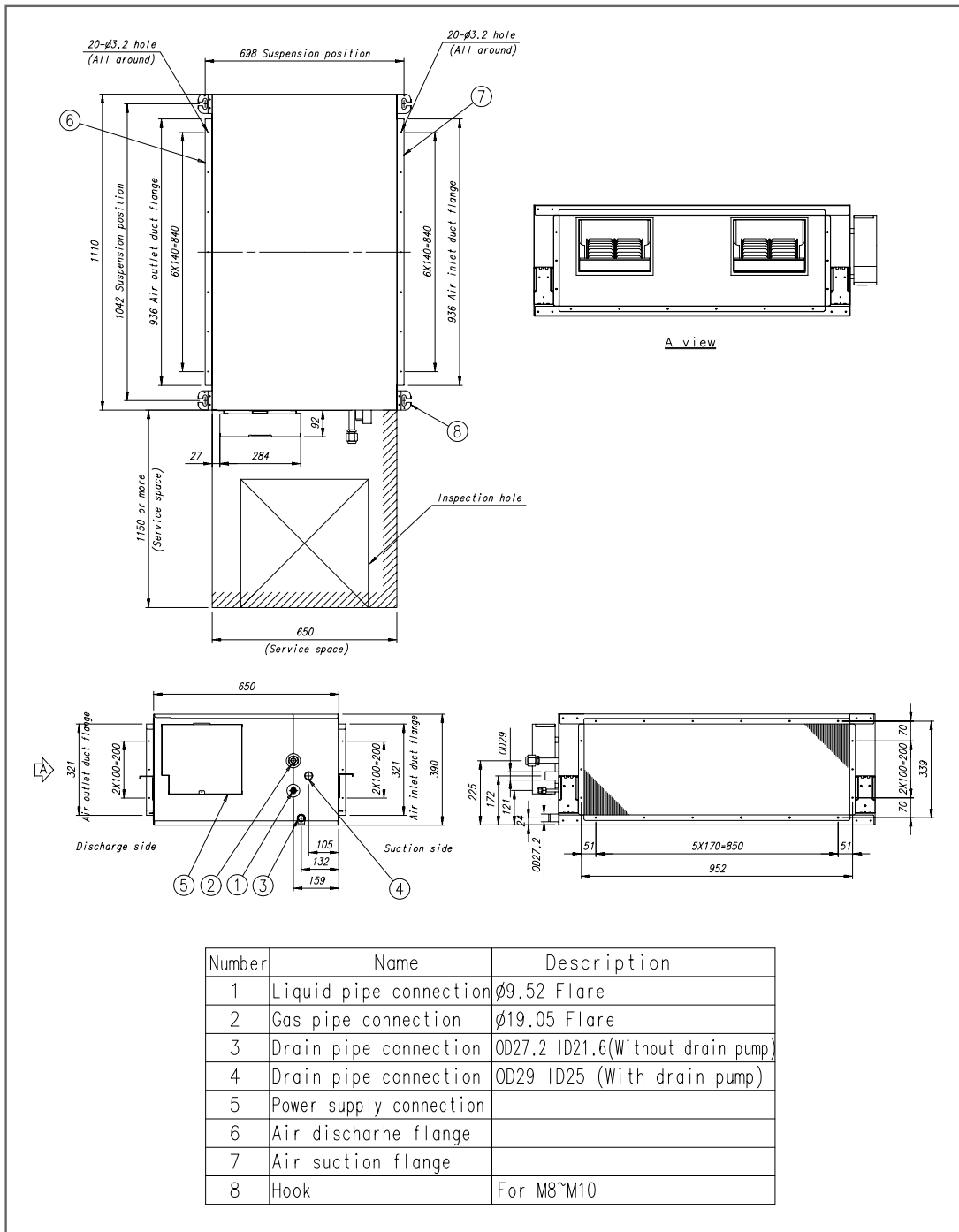

\*Caution\* ◆ If you want to install optional parts, refer to an appropriate installation manual.



## 5. Dimension

### 5-6. Wall-Mounted type

#### (1) 2.0kW ~ 4.0kW

Unit : mm

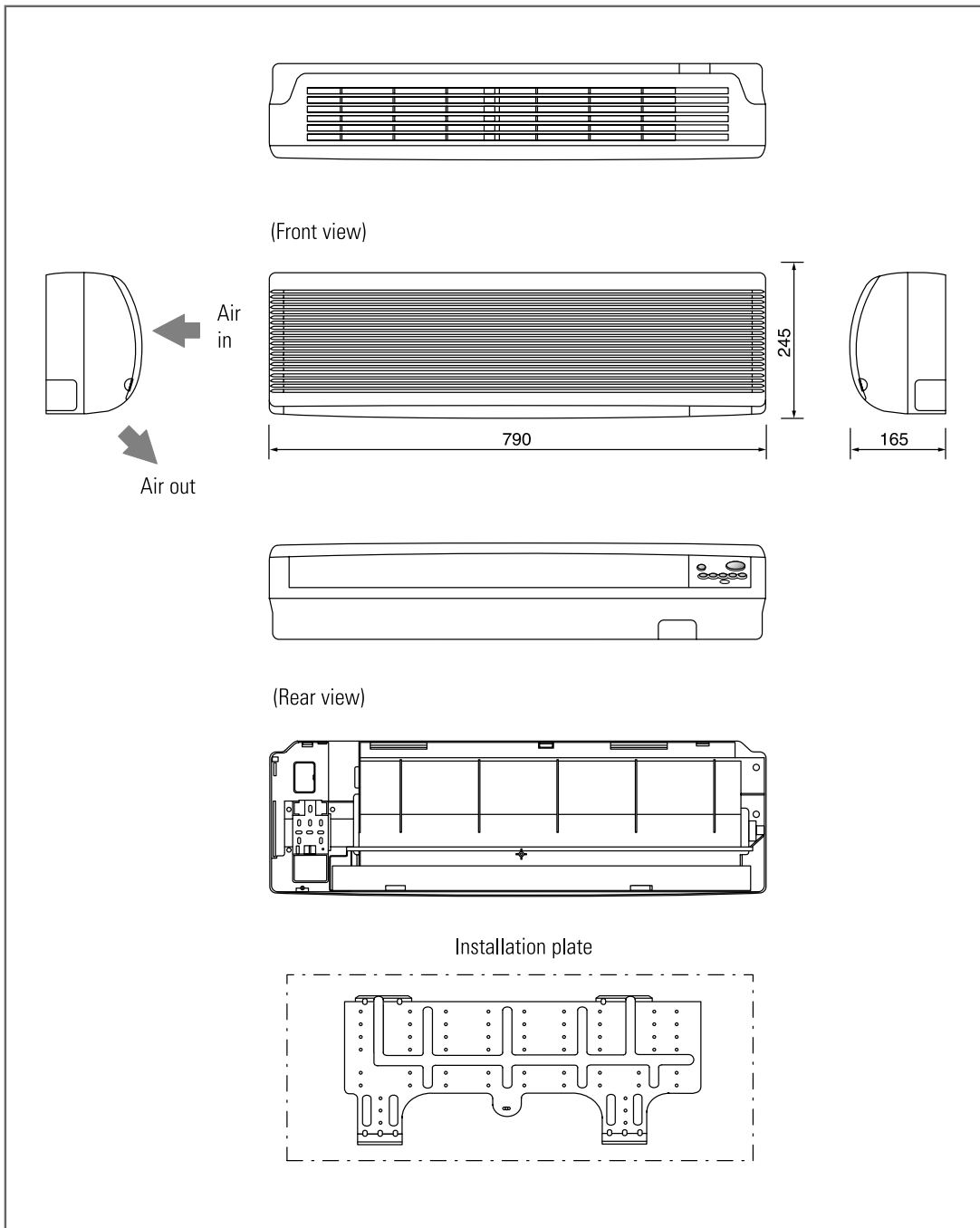

◆ If you want to install optional parts, refer to an appropriate installation manual.

(2) 5.2kW ~ 7.2kW

Unit : mm

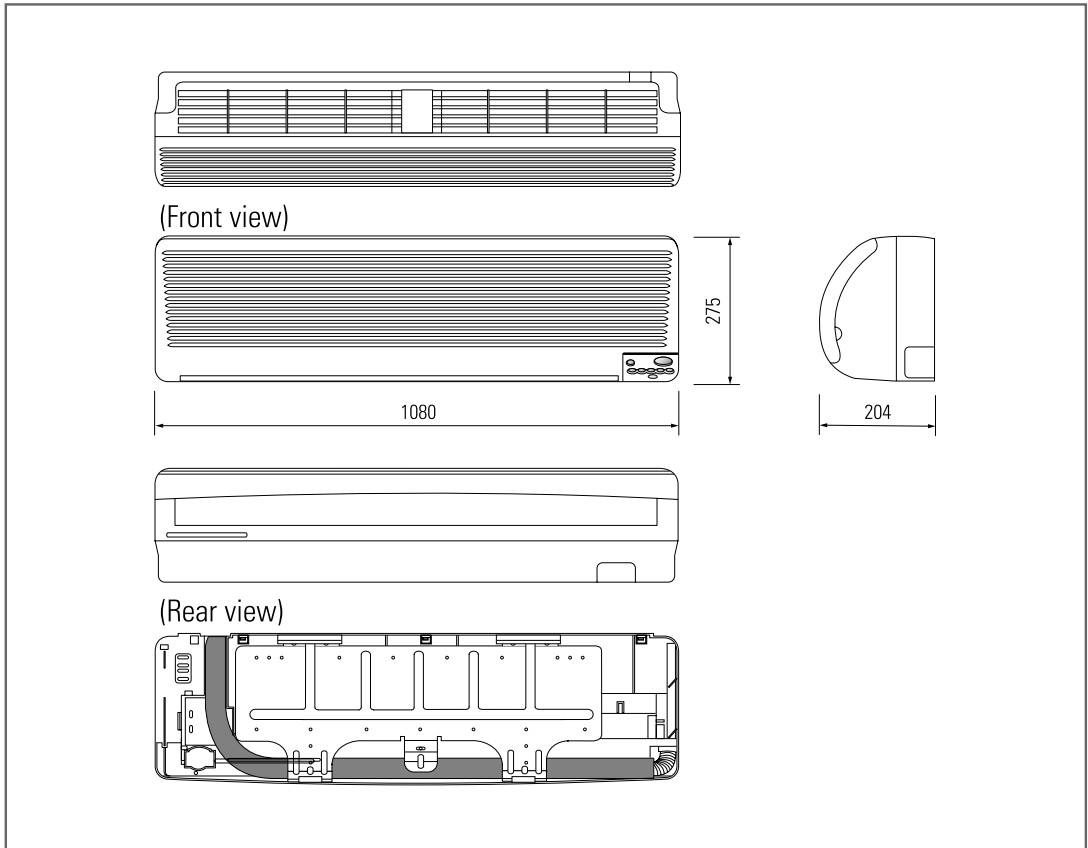

◆ If you want to install optional parts, refer to an appropriate installation manual.



## 5. Dimension

### 5-7. Floor standing type

Unit : mm

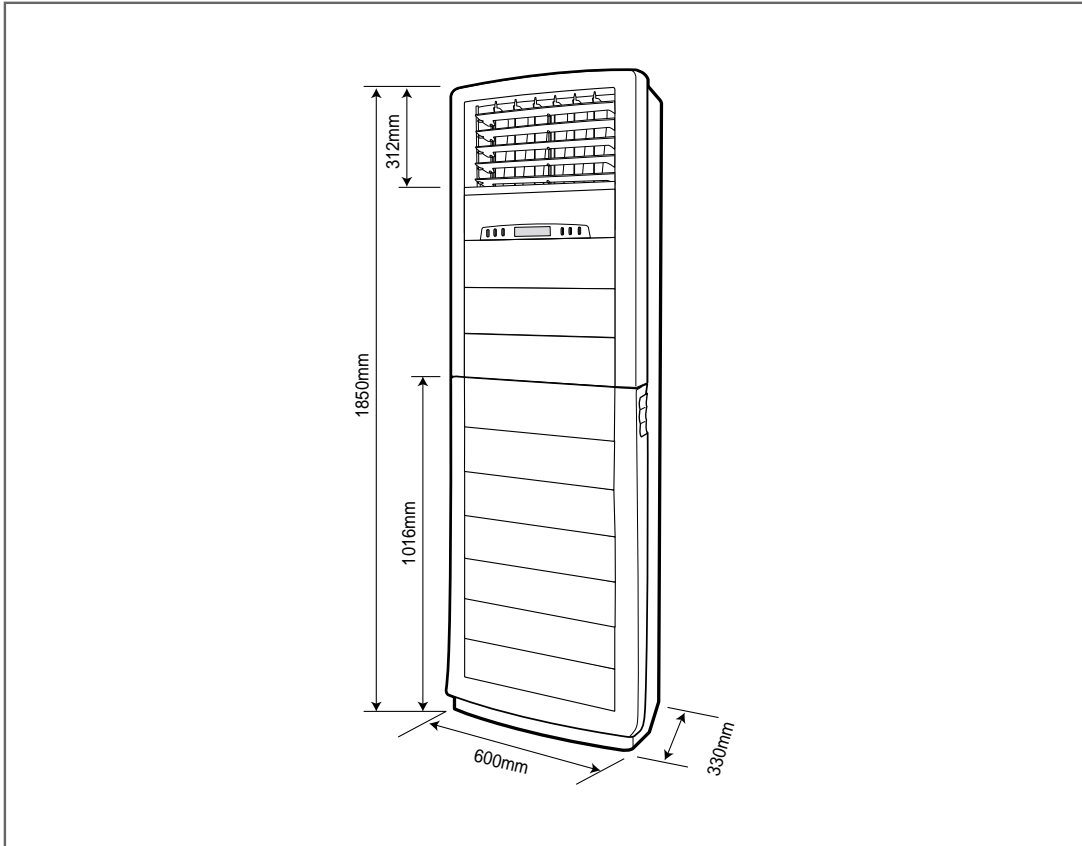

◆ If you want to install optional parts, refer to an appropriate installation manual.



## 5-8. Ceiling type

Unit : mm





## 5. Dimension

### 5-9. Wireless remote controller / Receiver

(1) For 1-way cassette / 4-way cassette / Wall-mounted / Floor standing / Ceiling type  
(AVMK\* / AVMC\* / AVMW\* / AVMP\* / AVMF\*)

◆ MR-AC01

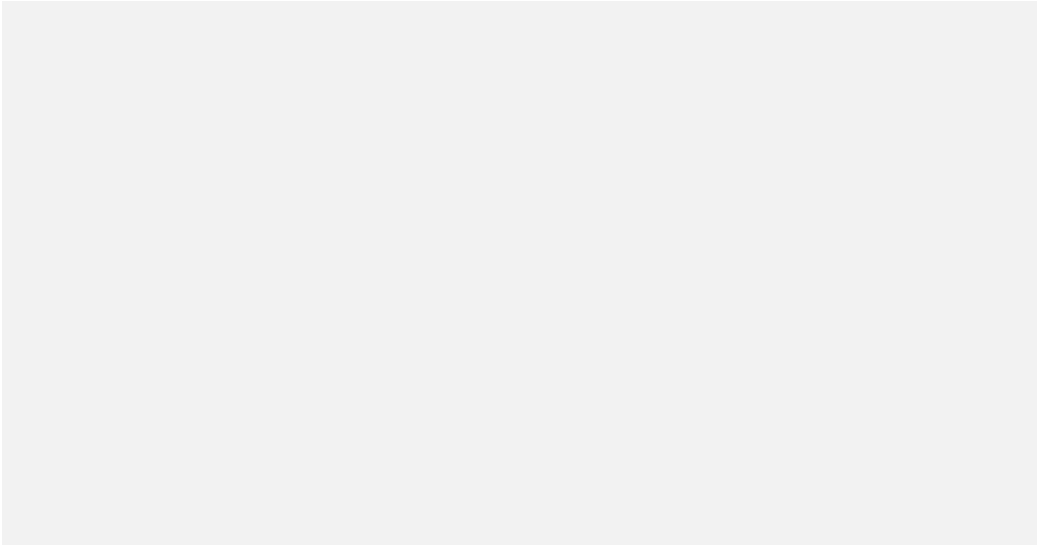

◆ MR-AH01

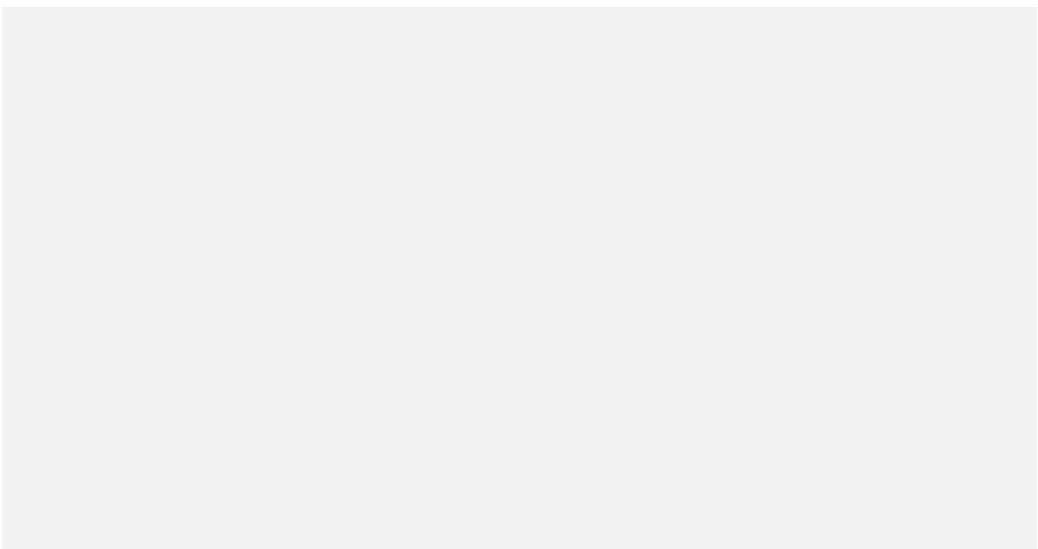

◆ AVMKC\*

MGKC118IE0
MGKC118IM0
MGKC118IA0
MGKC118IC0

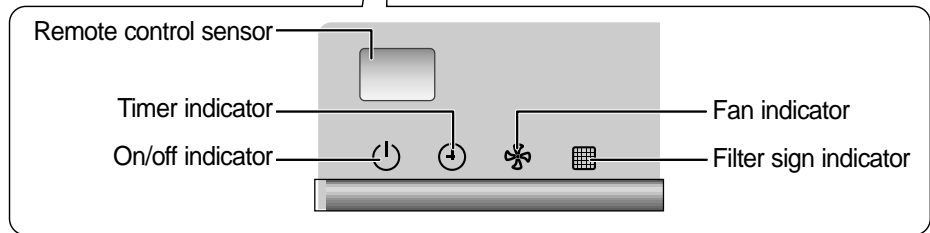
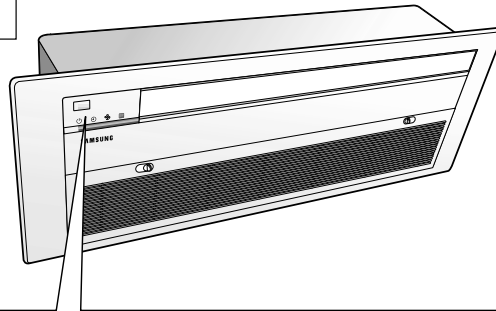

◆ AVMKH\*

MGKH118IE0
MGKH118IM0
MGKH118IA0
MGKH118IC0

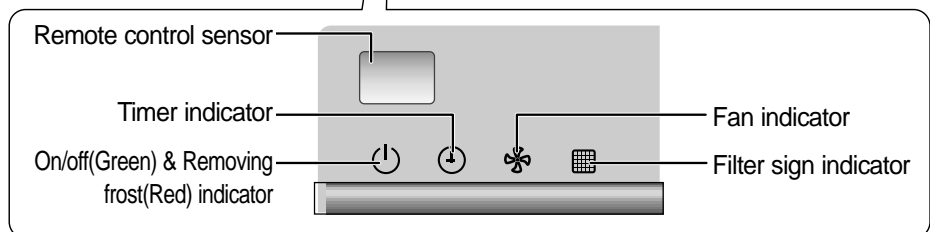
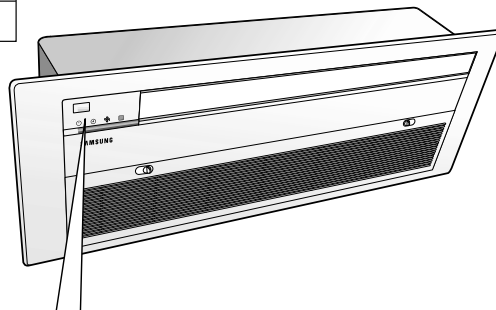



# 5. Dimension

## ◆ AVMCC\*

MGCC095IE0
MGCC095IM0
MGCC095IA0
MGCC095IC0

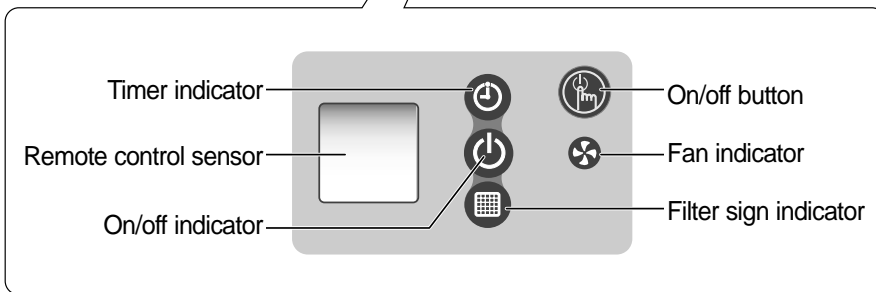
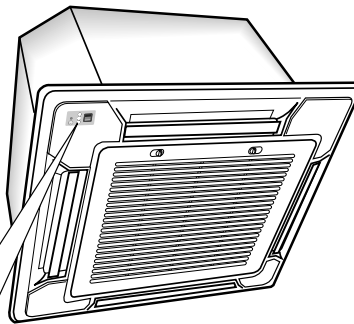

## ◆ AVMCH\*

MGCH095IE0
MGCH095IM0
MGCH095IA0
MGCH095IC0

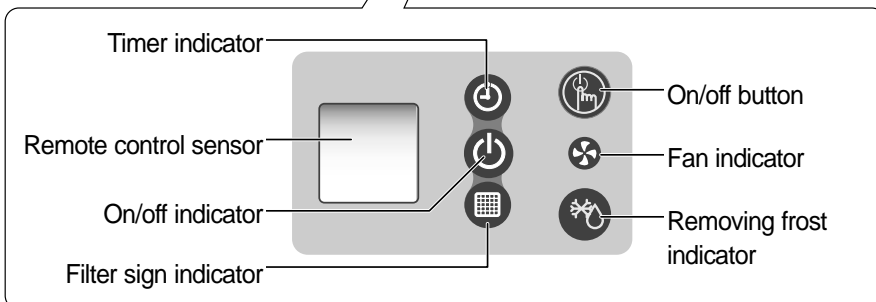
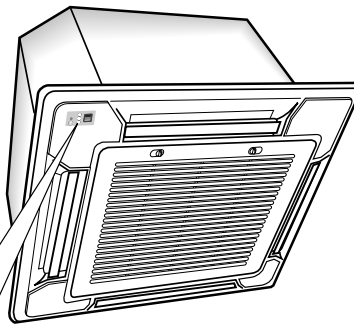

◆ AVMWC\*

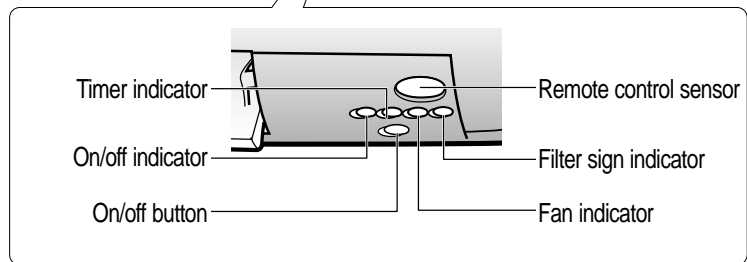
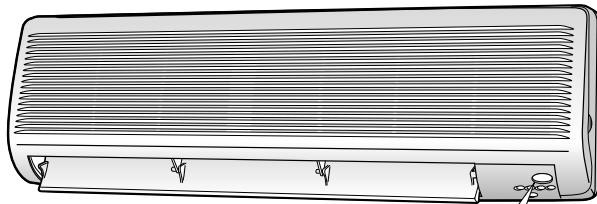

◆ AVMWH\*

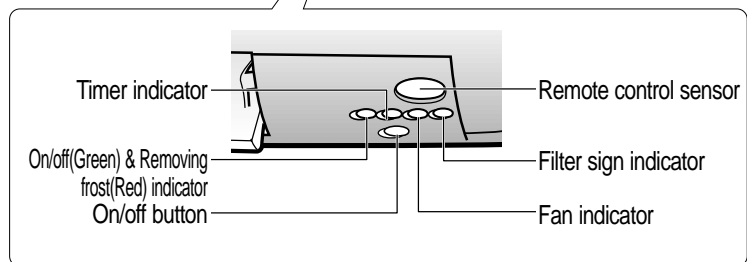
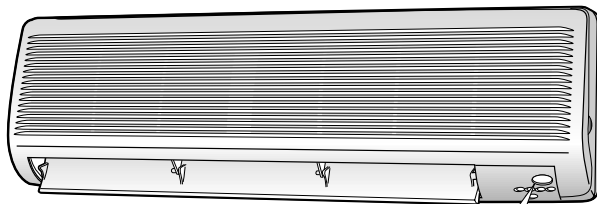



## 5. Dimension

### ◆ AVMPC\*

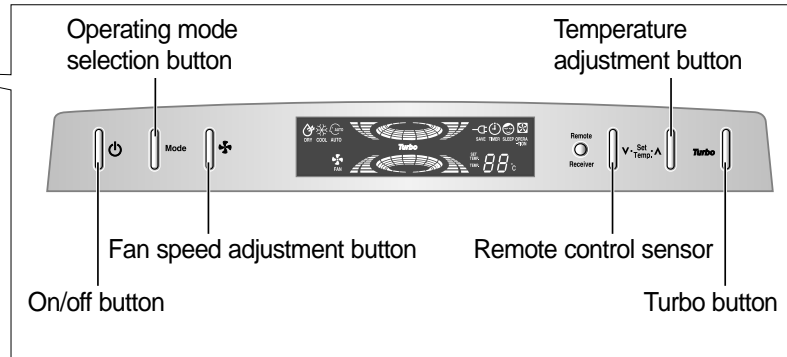
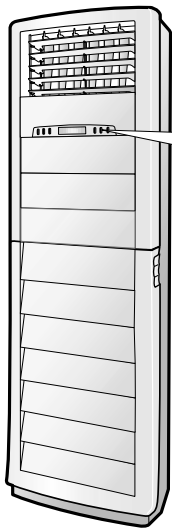

### ◆ AVMPH\*

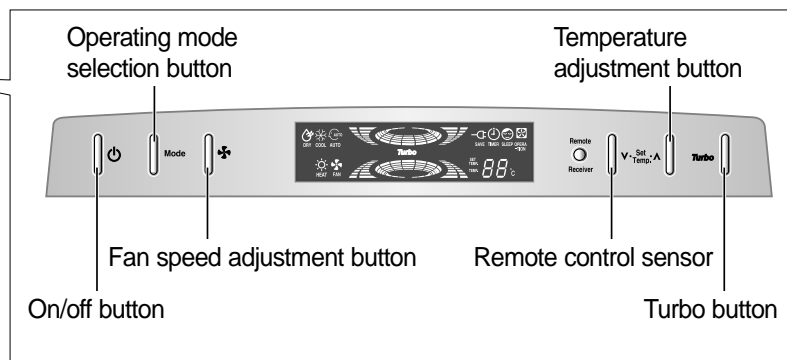
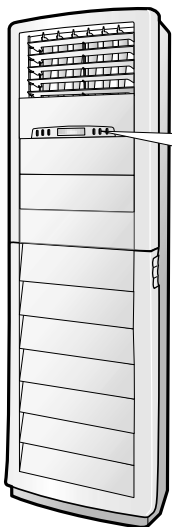

◆ AVMFC\*

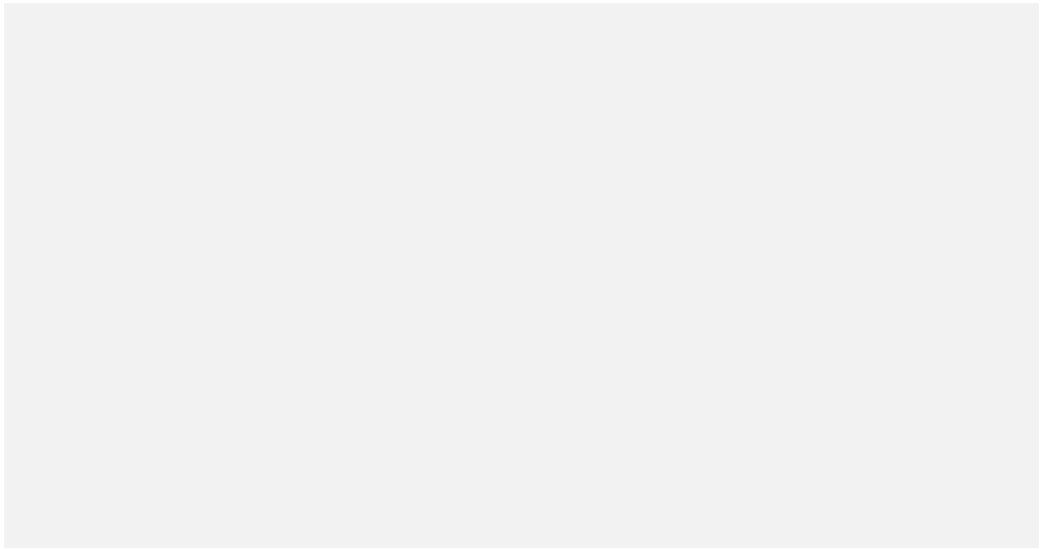

◆ AVMFH\*

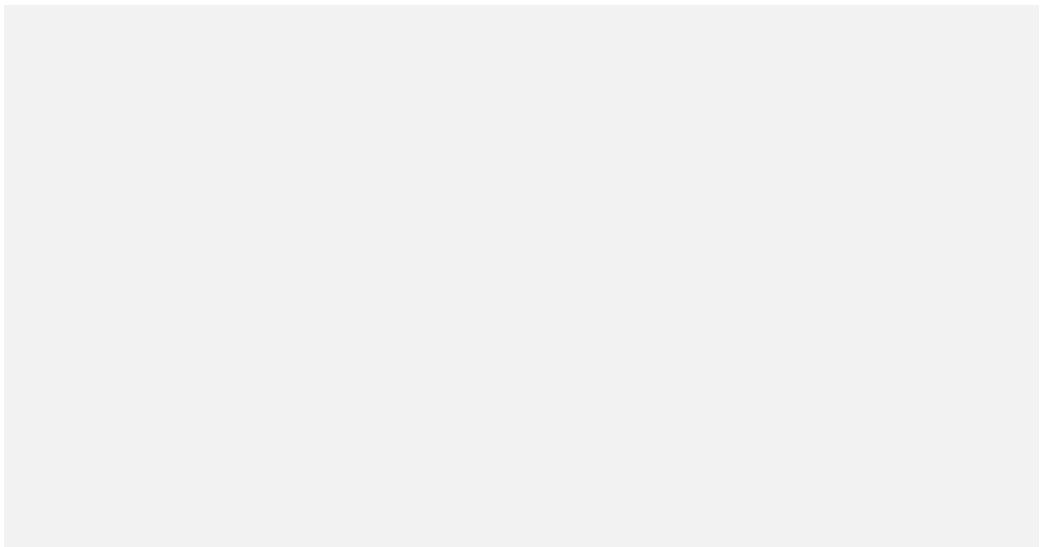



## 5. Dimension

### (2) For duct type (AVMD\* / AVMB\* / AVMH\*)

◆ MR-AC00

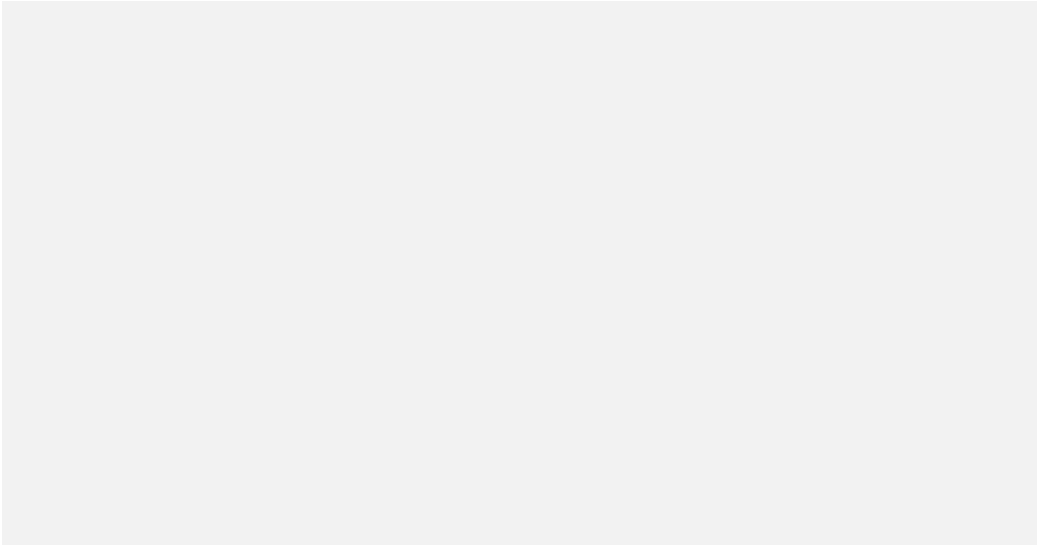

◆ MR-AH00

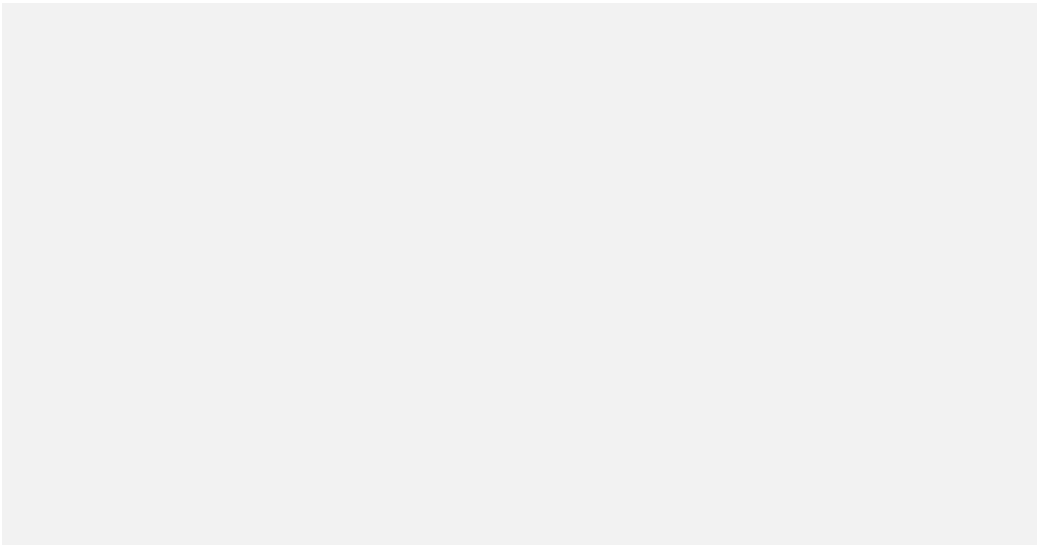



- ◆ MRK-B00(concealed type)
- ◆ MRW-10A(wire kit)

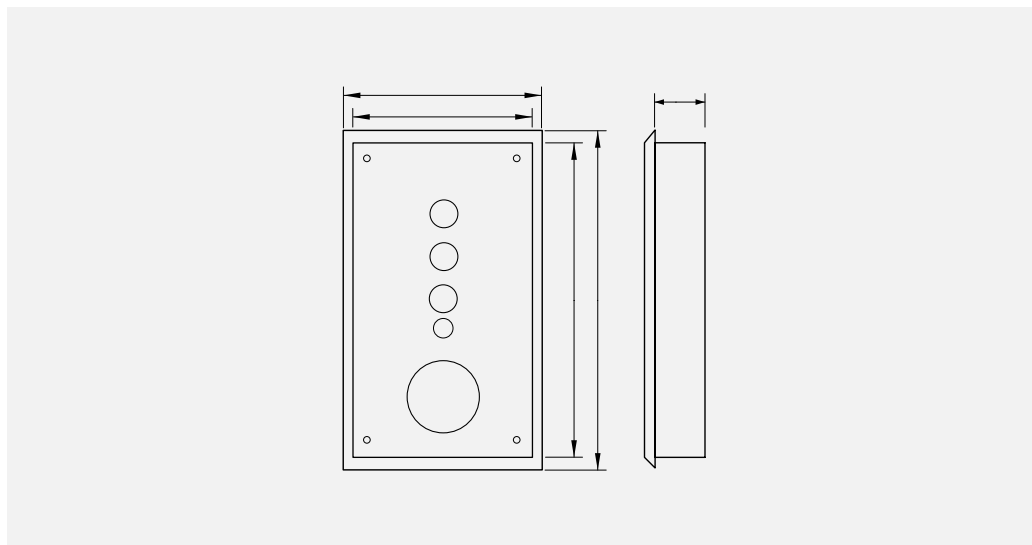

- ◆ MRK-A00(standard type)
- ◆ MRW-10A(wire kit)

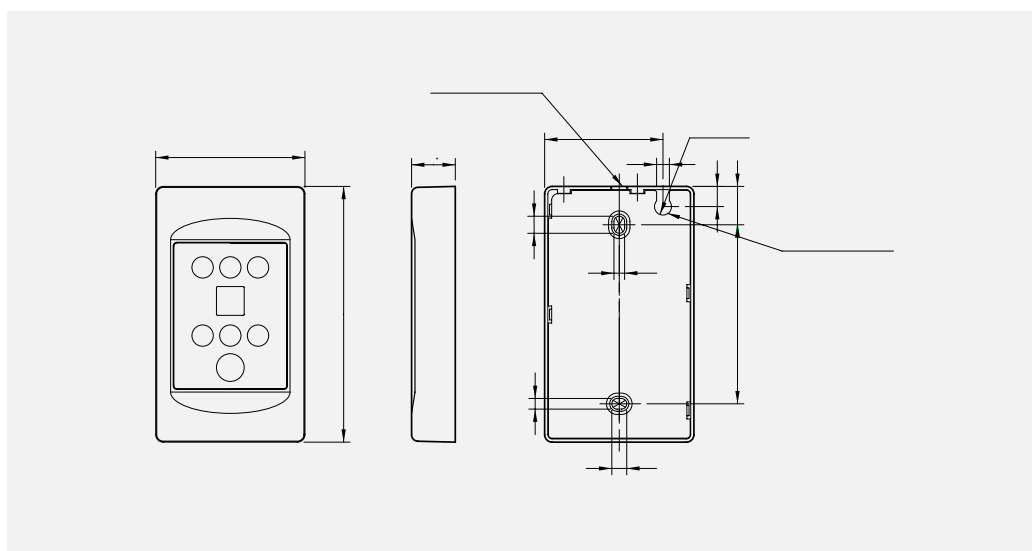



## 5. Dimension

### 5-10. Wired remote controller

(1) For 1-way cassette / 4-way cassette / Wall-mounted / Floor standing / Ceiling type  
(AVMK\* / AVMC\* / AVMW\* / AVMP\* / AVMF\*)

◆ MWR-AC01

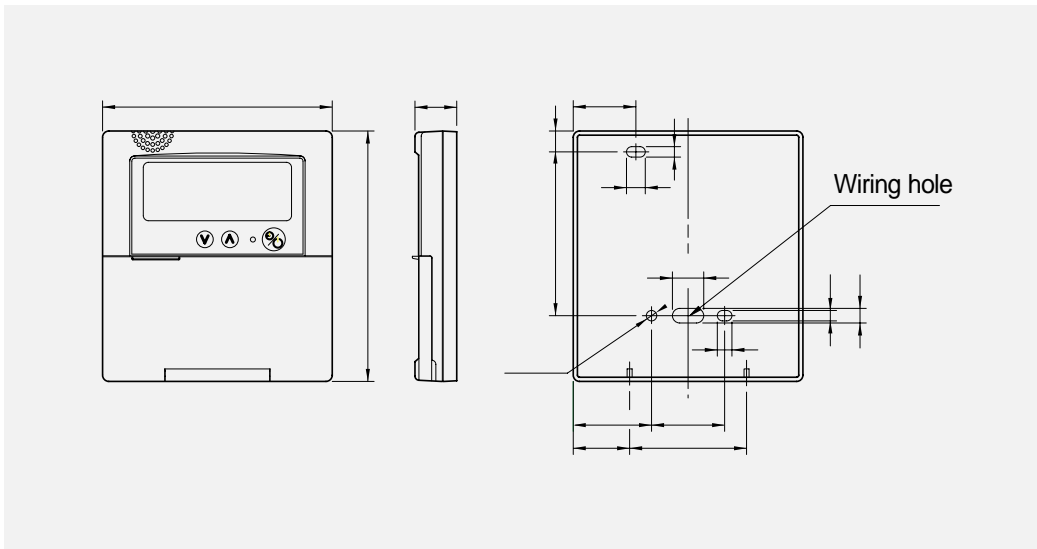

◆ MWR-AH01

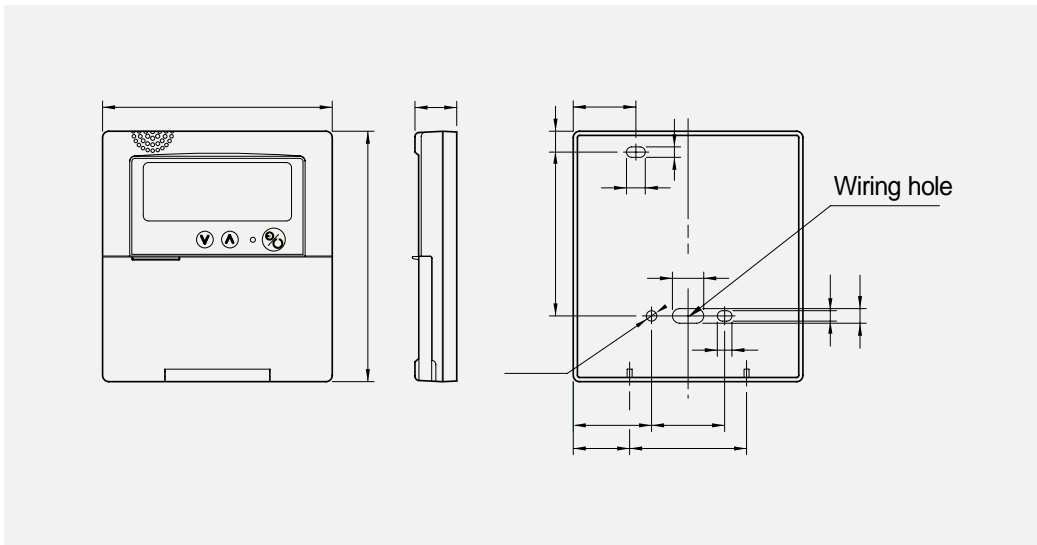

(2) For duct type (AVMD\* / AVMB\* / AVMH\*)

◆ MWR-AC00

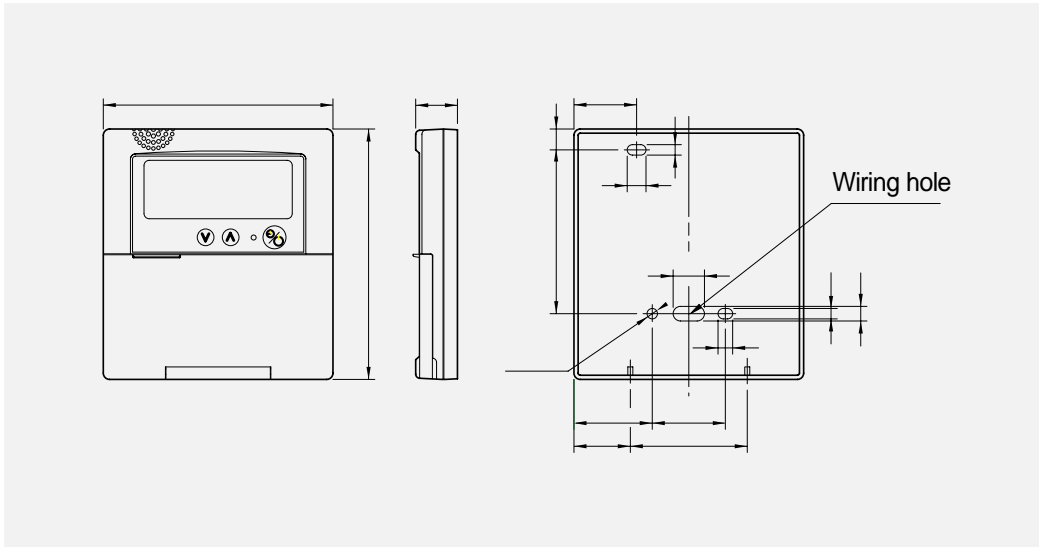

◆ MWR-AH00

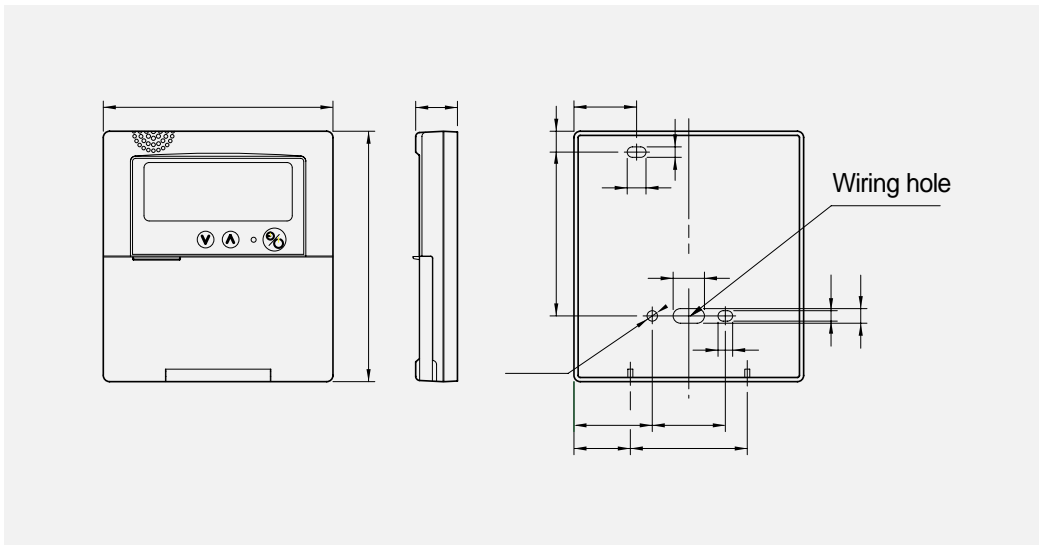



## 5. Dimension

### 5-11. Option controller

#### (1) Centralized controller

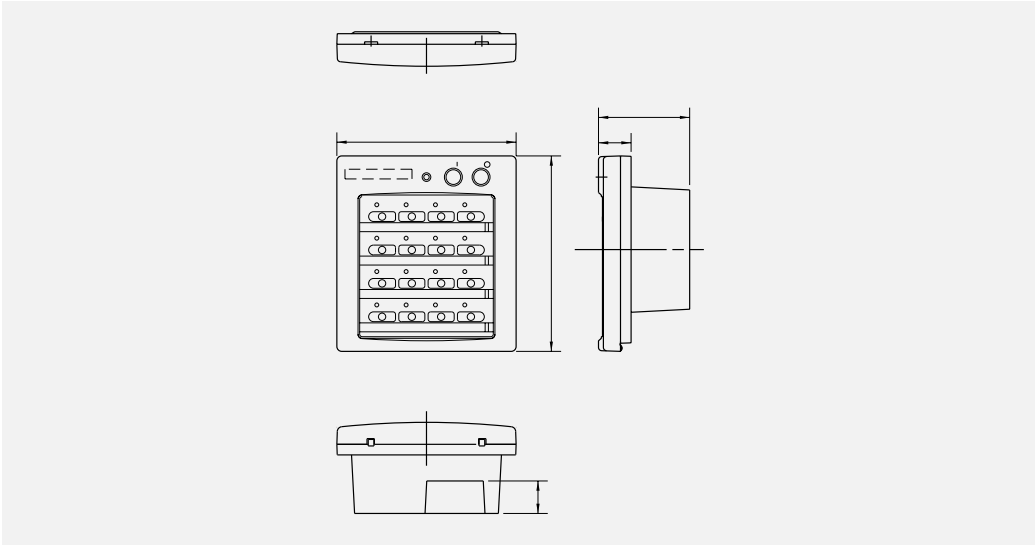

#### (2) Function controller

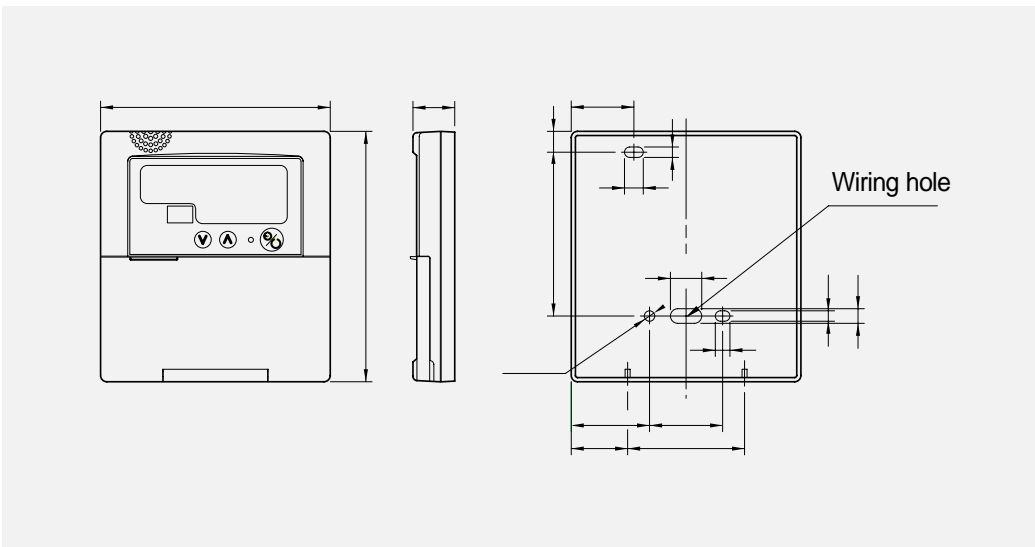

## 6. Refrigerant system diagram(Cooling only & heat pump)

### 6-1. Refrigerant system diagram

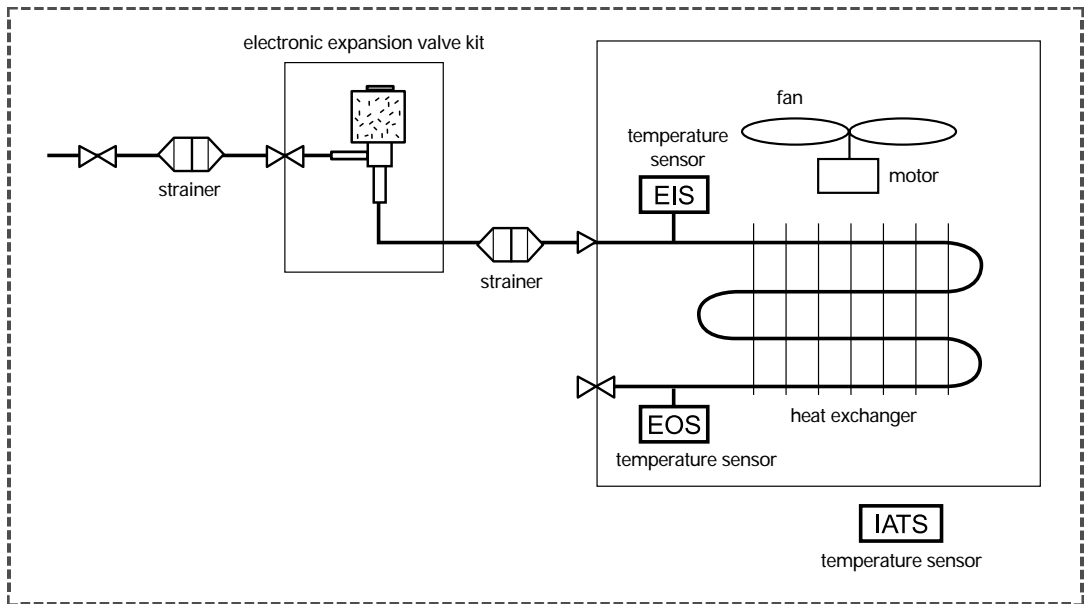

### 6-2. Main parts status

#### (1) Temperature sensor (EIS, Evaporator Inlet Sensor)

The means to measure the refrigerant temperature at the inlet of heat exchanger which is used as the data for control of electronic expansion valve.

#### (2) Temperature sensor (EOS, Evaporator Outlet Sensor)

The means to measure the refrigerant temperature at the outlet of heat exchanger which is used as the data for control of electronic expansion valve.

#### (3) Temperature sensor (IATS, Indoor Air Temperature Sensor)

The means to measure the indoor temperature which is used as the data for operation method of indoor and outdoor unit.

#### (4) Electronic expansion valve (EEV) kit

For the MICOM of indoor unit to control the opening of electronic expansion valve by comparing the temperatures of inlet and outlet of heat exchanger for the optimum control of refrigerant flow.

#### (5) Strainer

It has the structure in which the filter is inserted and it removes the foreign material from the piping inside.



# 7. Electric circuit diagram

## 7-1. 1-way cassette type

### (1) Cooling only (AVMKC\*)

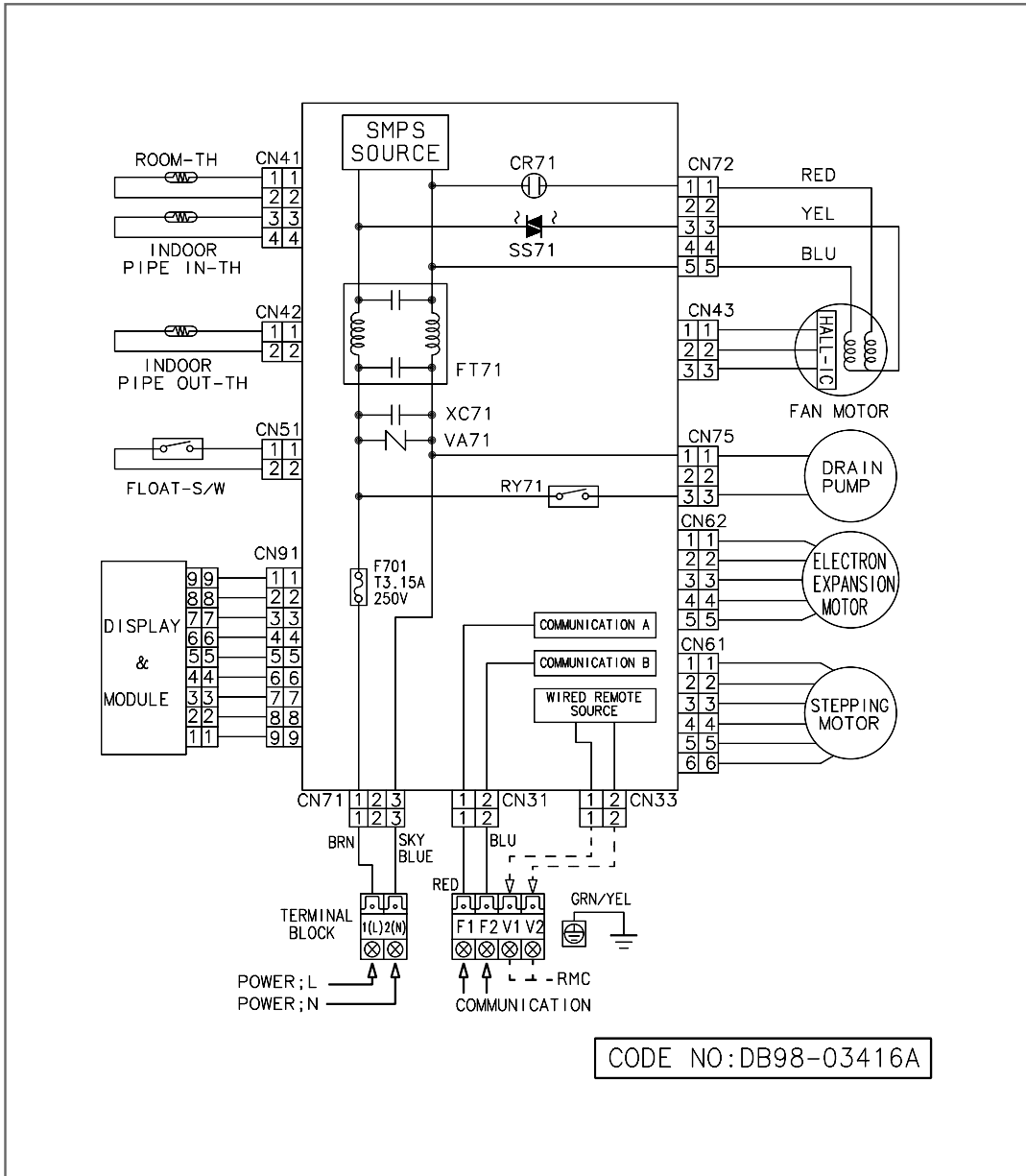

## (2) Heat pump (AVMKH\*)

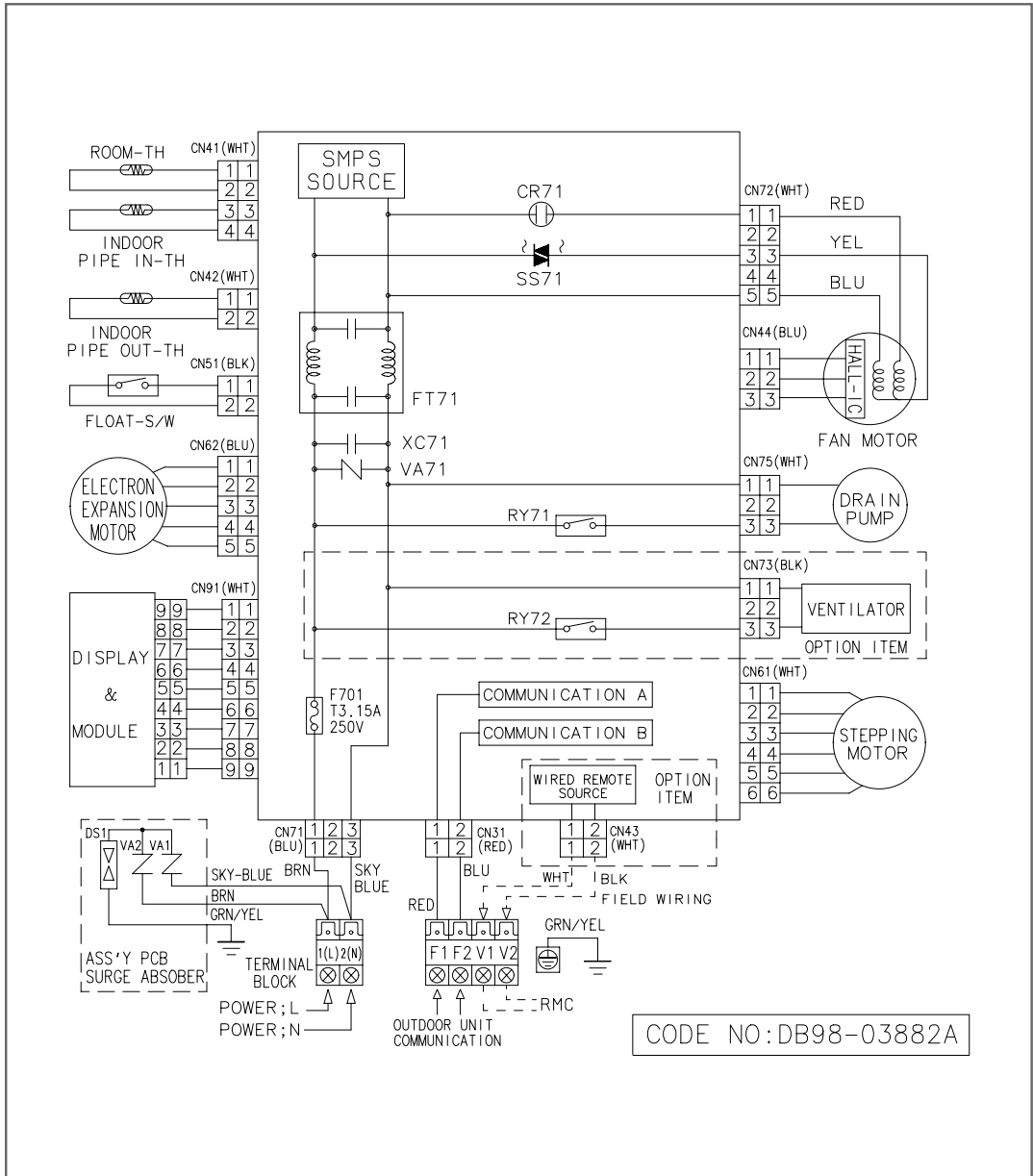



# 7. Electric circuit diagram

## 7-2. 4-way cassette type

### (1) Cooling only (AVMCC\*)

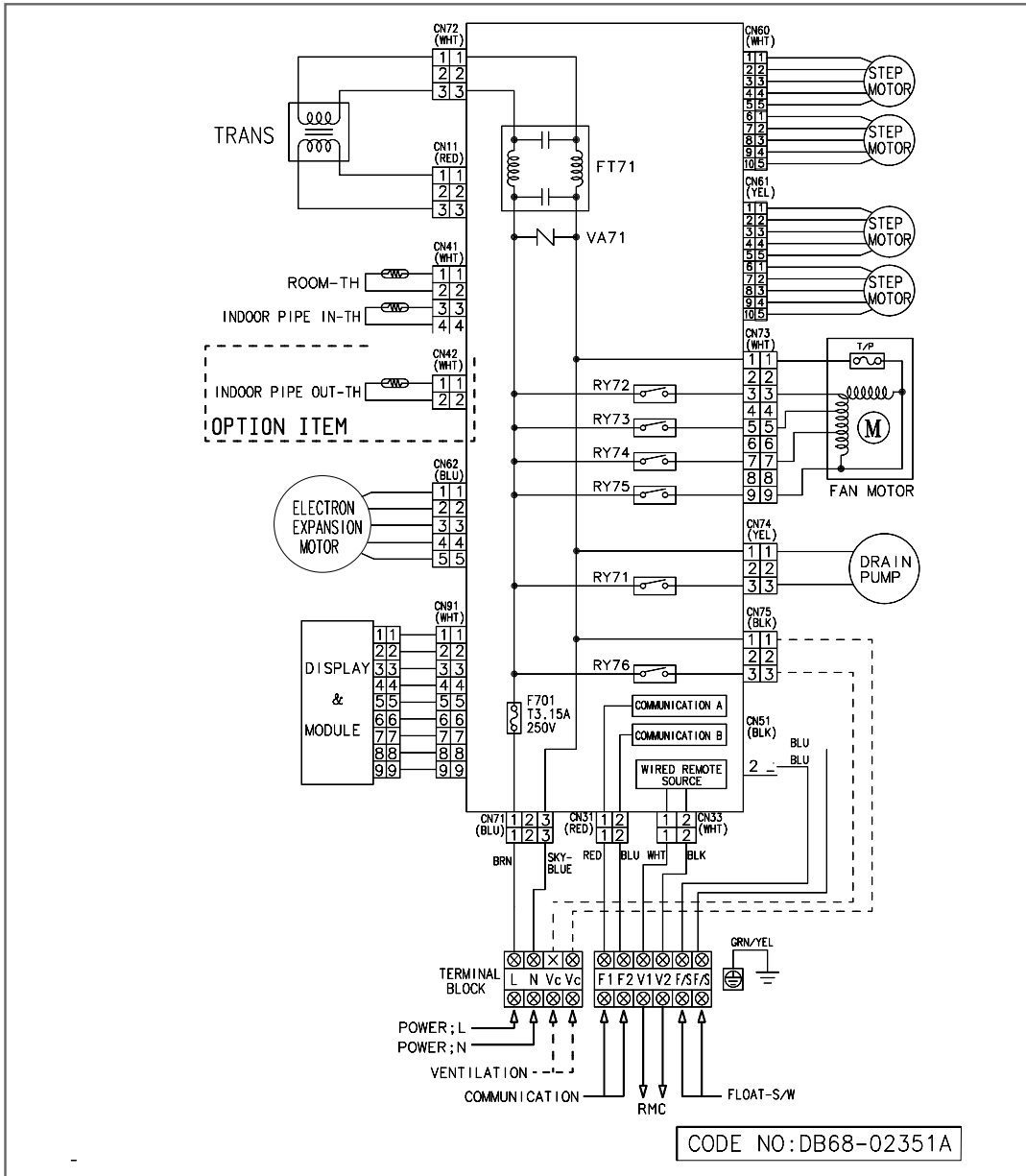



## (2) Heat pump (AVMCH\*)

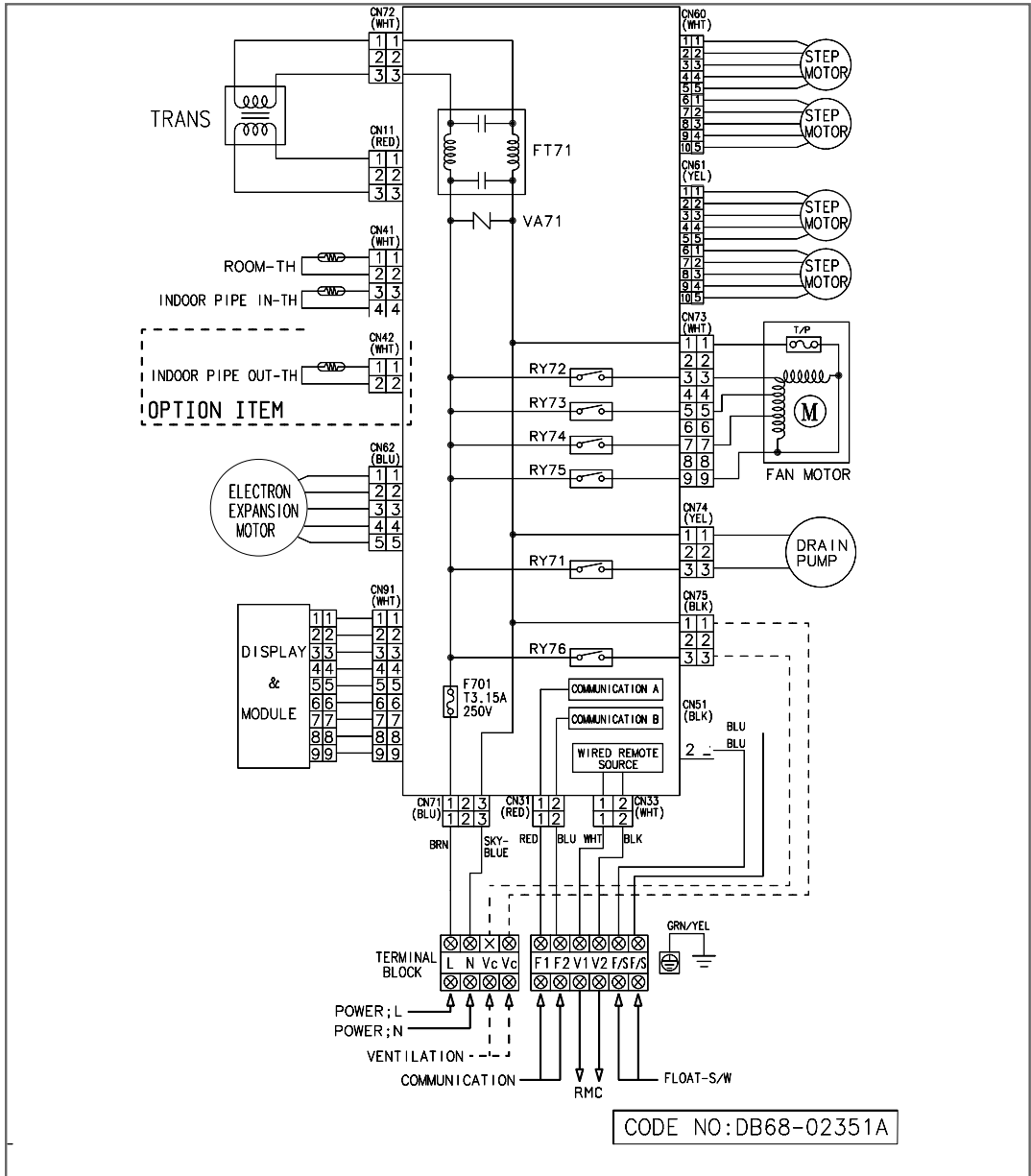



**(2) Heat pump (AVMDH\* / AVMBH\* / AVMHH\*)**

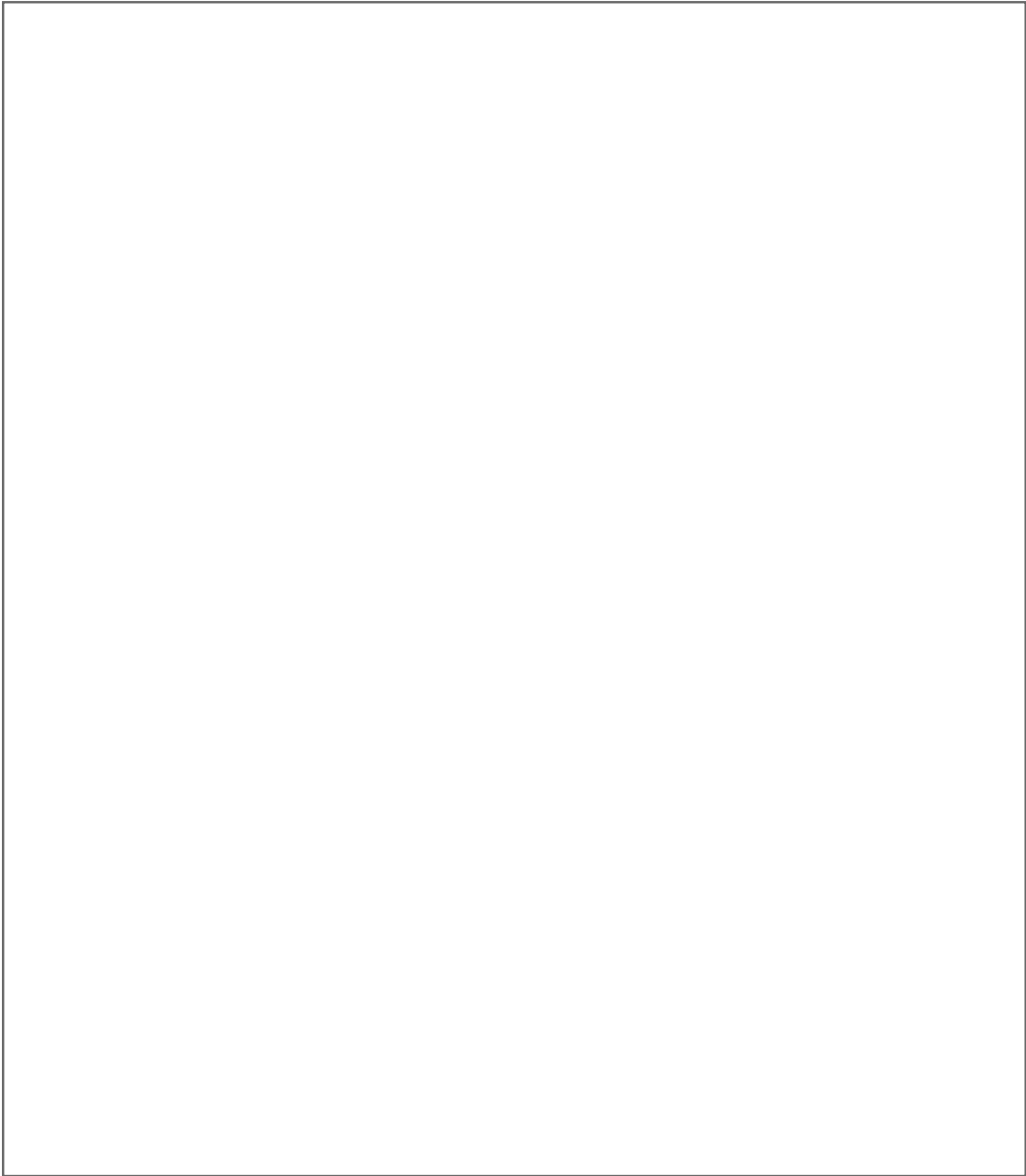



## 7. Electric circuit diagram

### 7-4. Wall-mounted type

#### (1) Cooling only (AVMWC\*)

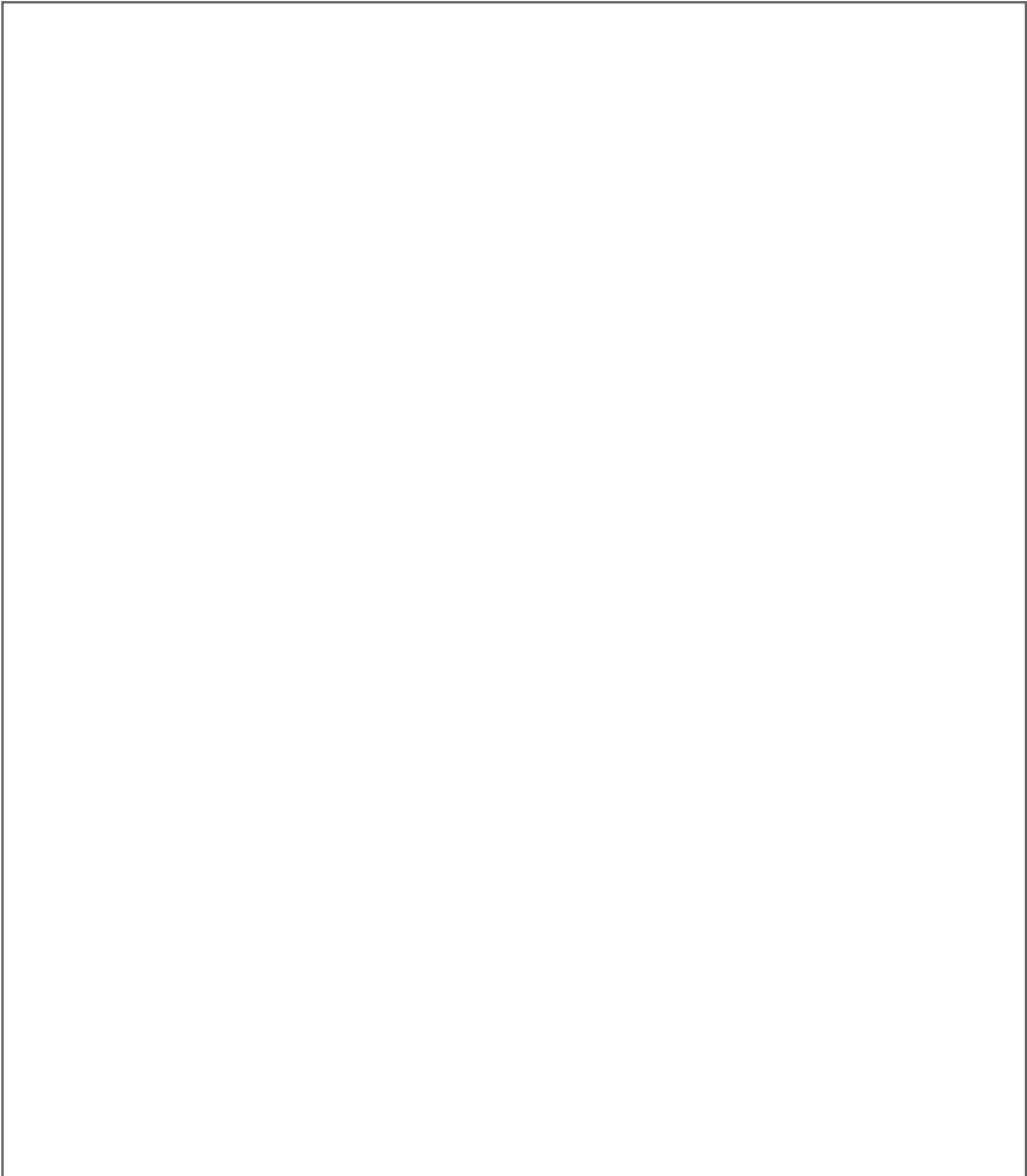

**(2) Heat pump (AVMWH\*)**

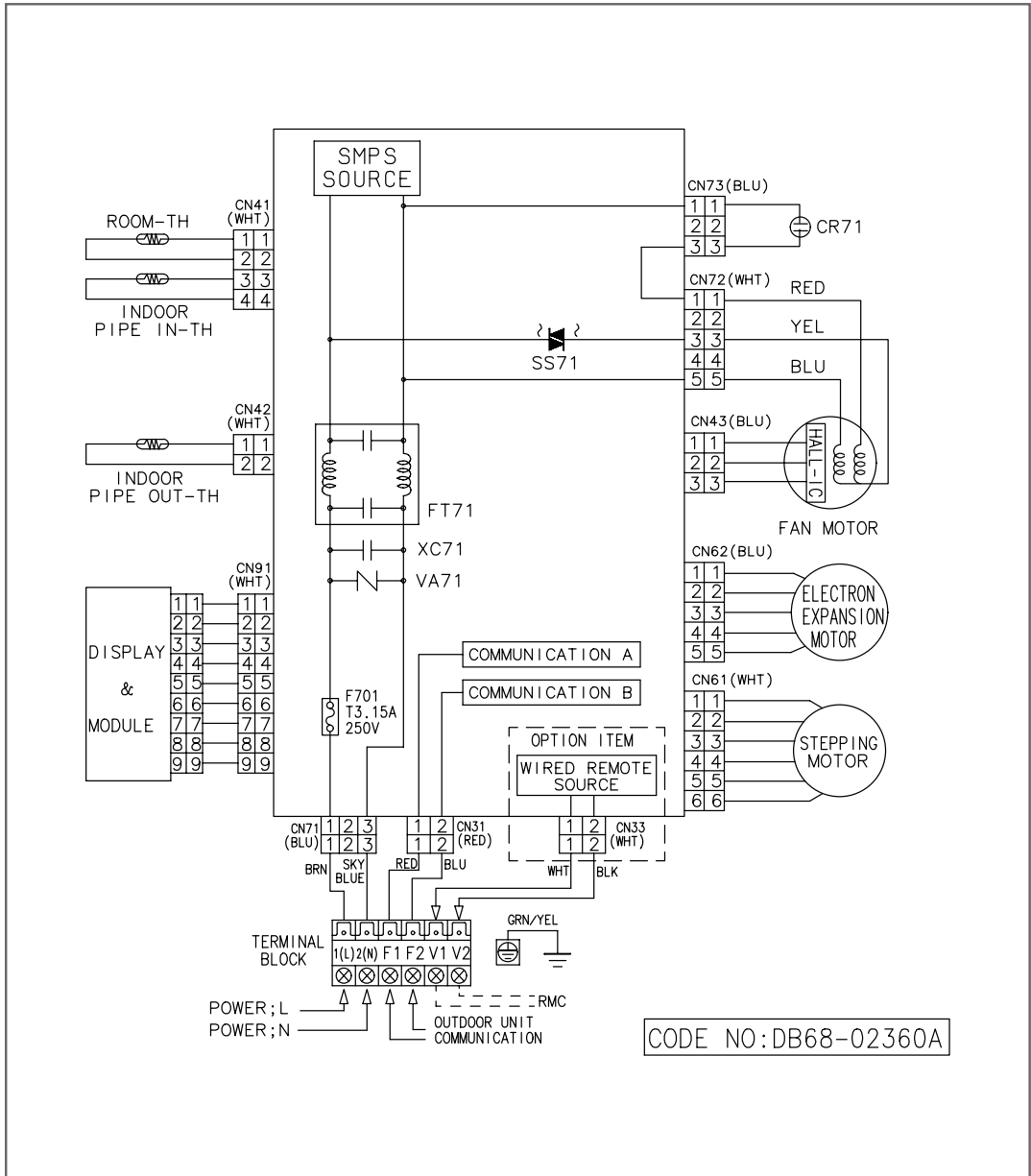



## 7. Electric circuit diagram

### 7-5. Floor standing type

#### (1) Cooling only (AVMPC\*)

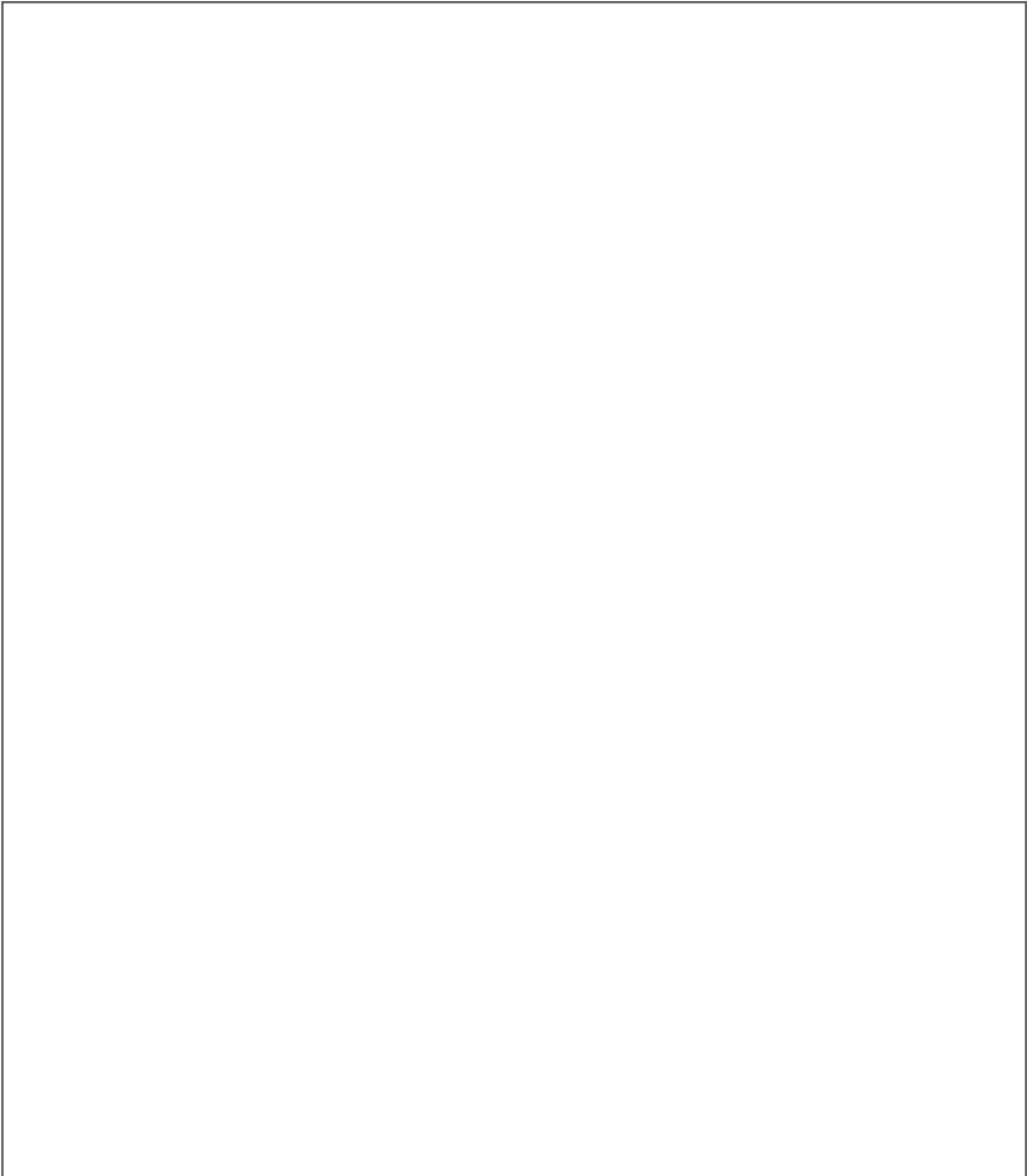

**(2) Heat pump (AVMPH\*)**

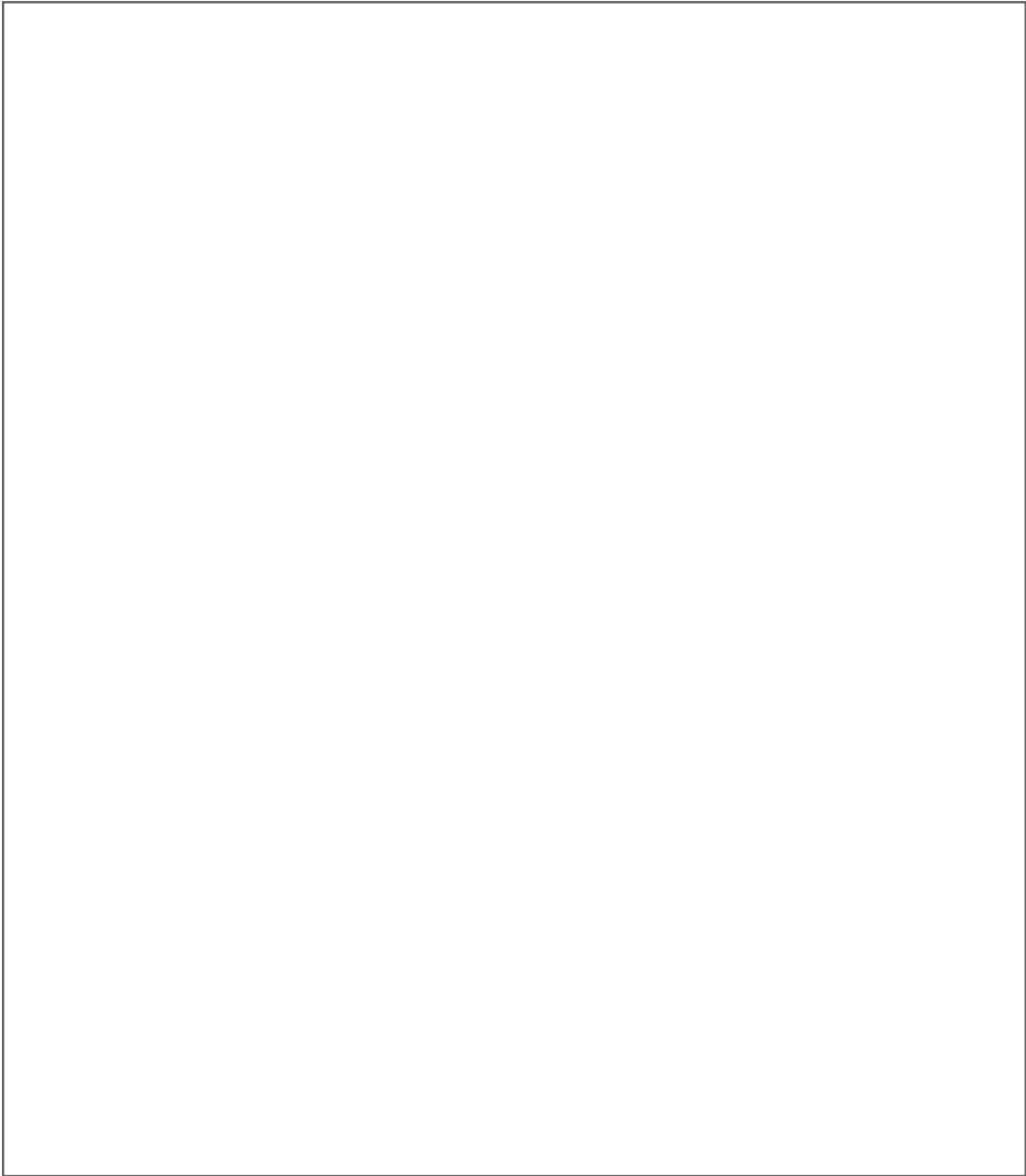



## 7. Electric circuit diagram

### 7-6. Ceiling type

#### (1) Cooling only (AVMFC\*)

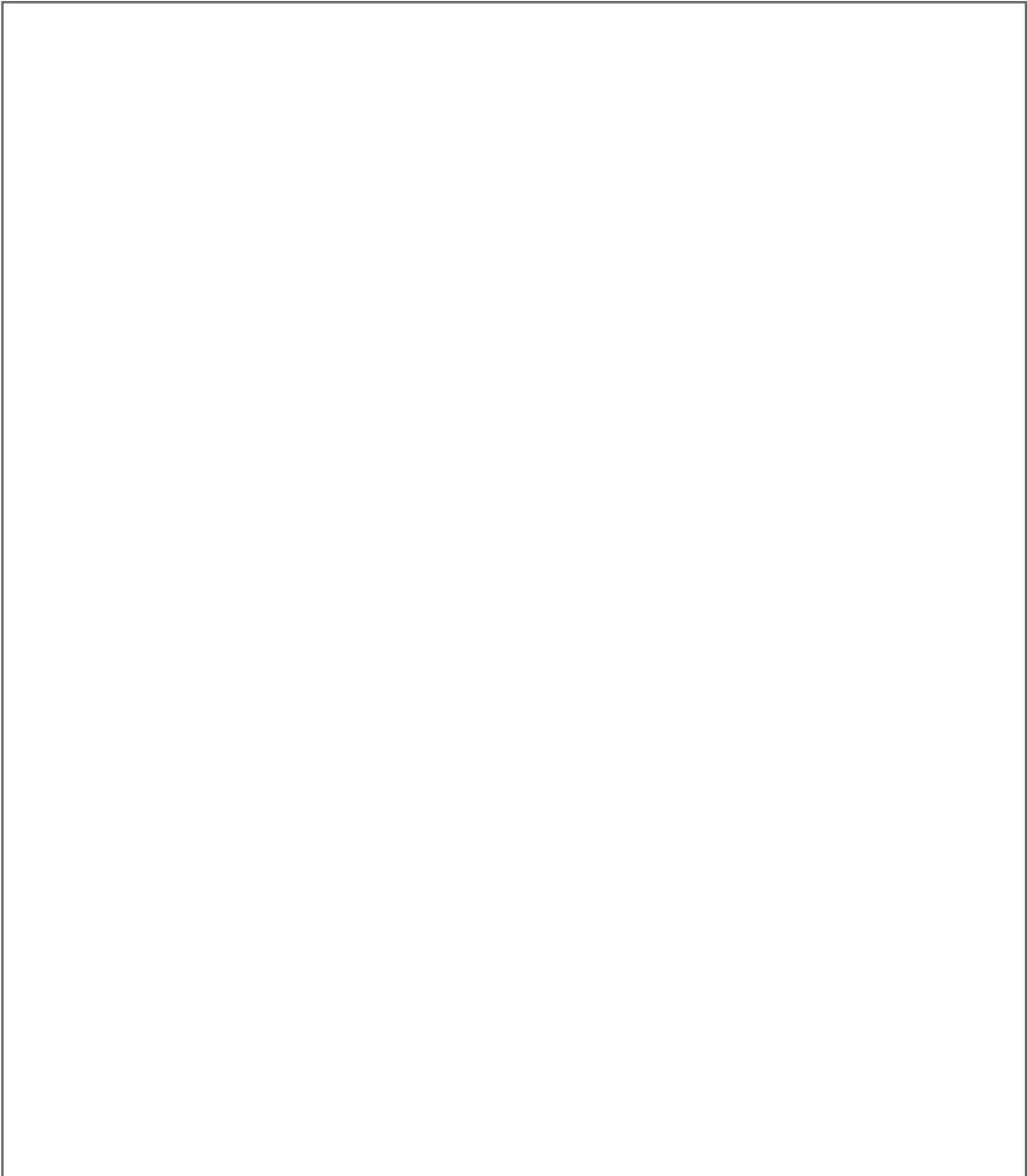



**(2) Heat pump (AVMFH\*)**

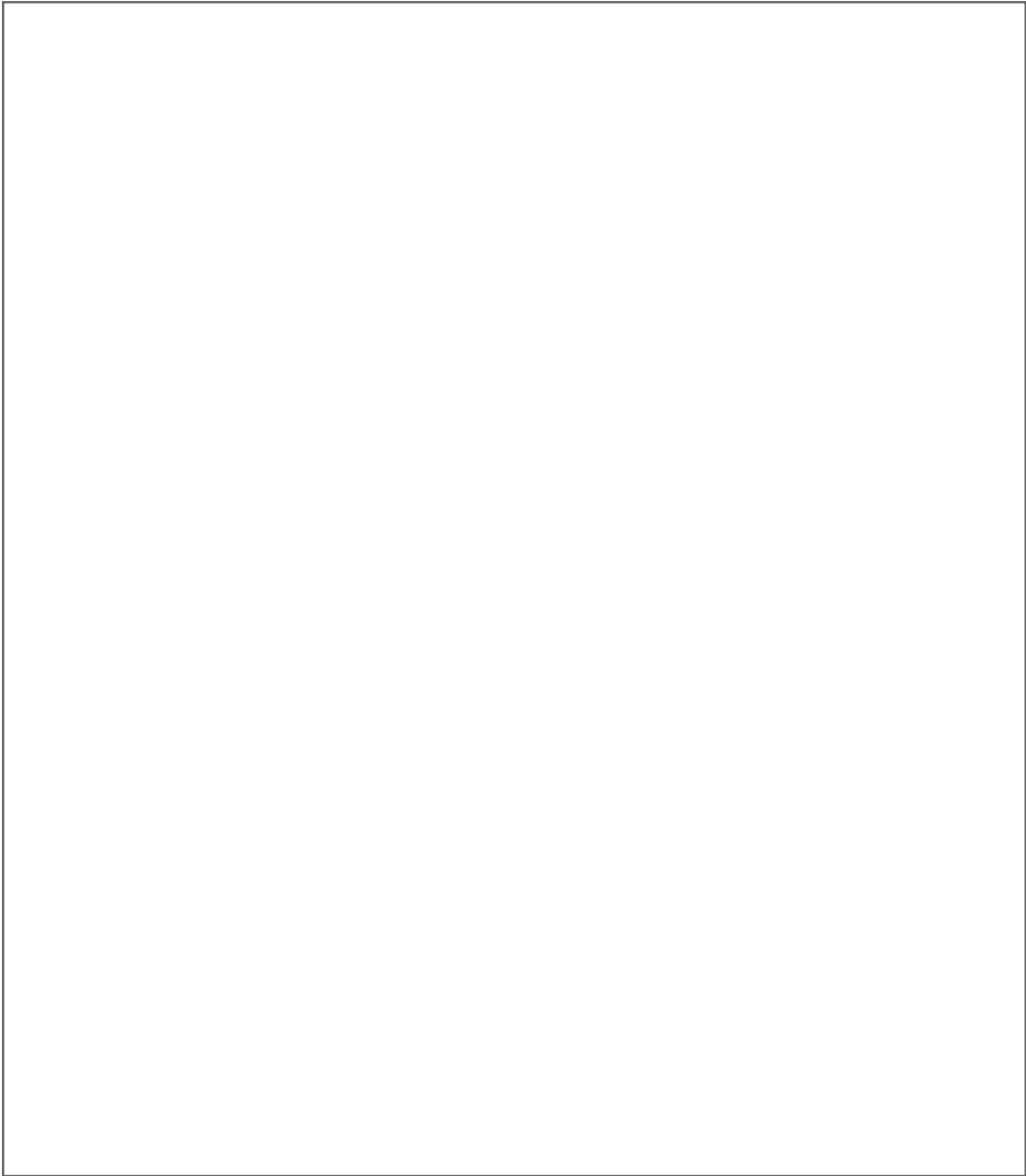



# 8. Noise level

## 8-1. Overall

### ◆ 1-way cassette type

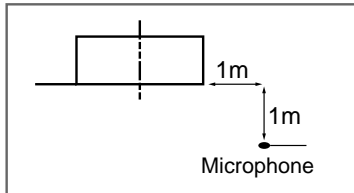

Model	230V/50Hz		220V/60Hz	
	High	Low	High	Low
**020**	32.0	29.0	32.0	29.0
**026/032**	36.0	32.0	36.0	32.0
**035/040**	38.0	35.0	38.0	35.0

### ◆ 4-way cassette type

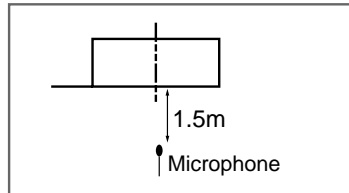

Model	230V/50Hz		220V/60Hz	
	High	Low	High	Low
**052**	31.0	28.0	31.0	28.0
**070/072**	35.0	32.0	35.0	32.0
**105**	41.0	34.0	41.0	34.0

### ◆ Duct type(Low silhouette)

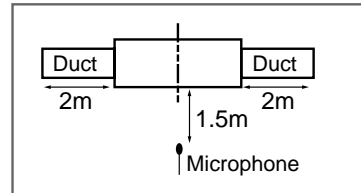

Model	230V/50Hz		220V/60Hz	
	High	Low	High	Low
**052**	35.0	32.0	35.0	32.0
**070/072**	38.0	36.0	38.0	36.0

### ◆ Duct type(Built-in)

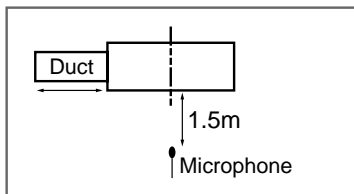

Model	230V/50Hz		220V/60Hz	
	High	Low	High	Low
**020**	37.0	34.0	37.0	34.0
**026/032**	40.0	37.0	40.0	37.0
**035/040**	40.0	38.0	40.0	38.0
**052**	40.0	38.0	40.0	38.0
**070/072**	42.0	40.0	42.0	40.0

### ◆ Duct type(High pressure)

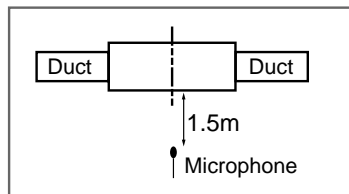

Model	230V/50Hz		220V/60Hz	
	High	Low	High	Low
**105**	43.0	45.0	43.0	45.0
**128**	42.0	44.0	42.0	44.0

### ◆ Wall-mounted type

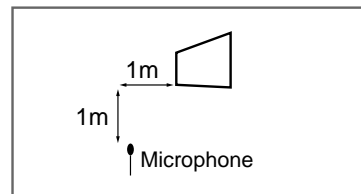

Model	230V/50Hz		220V/60Hz	
	High	Low	High	Low
**020**	29.0	28.0	29.0	28.0
**026/032**	34.0	30.0	34.0	30.0
**035/040**	38.0	35.0	38.0	35.0
**052**	41.0	37.0	41.0	37.0
**070/072**	44.0	41.0	44.0	41.0

### ◆ Floor standing type

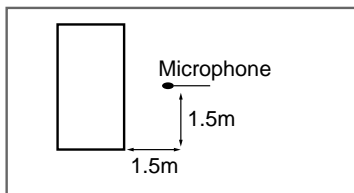

Model	230V/50Hz		220V/60Hz	
	High	Low	High	Low
**060**	37.0	35.0	37.0	35.0
**070/072**	42.0	40.0	42.0	40.0
**082/083**	44.0	41.0	44.0	41.0

### ◆ Ceiling type

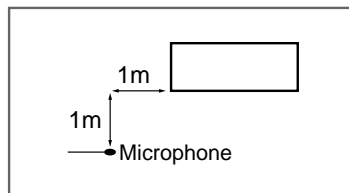

Model	230V/50Hz		220V/60Hz	
	High	Low	High	Low
**052**	43.0	40.0	43.0	40.0
**070/072**	45.0	40.0	45.0	40.0



- ◆ These test results are based on the standard installation condition.
- ◆ Actual noise level may differ, depending on the room structure, etc. since these noise values are from an anechoic room.

## 8-2. Octave band level

### (1) 1-way cassette type

**\*\*020\*\***

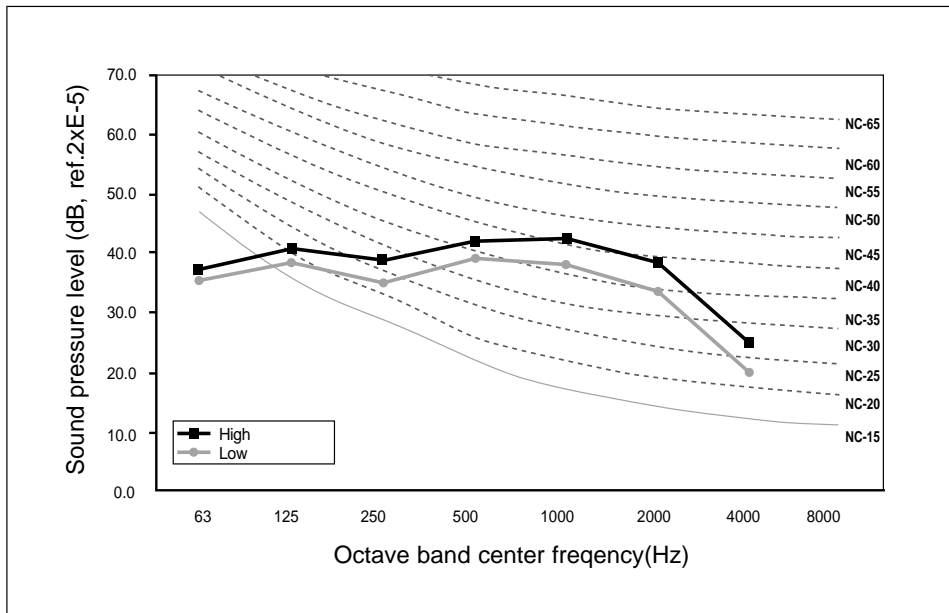

**\*\*026/032\*\***

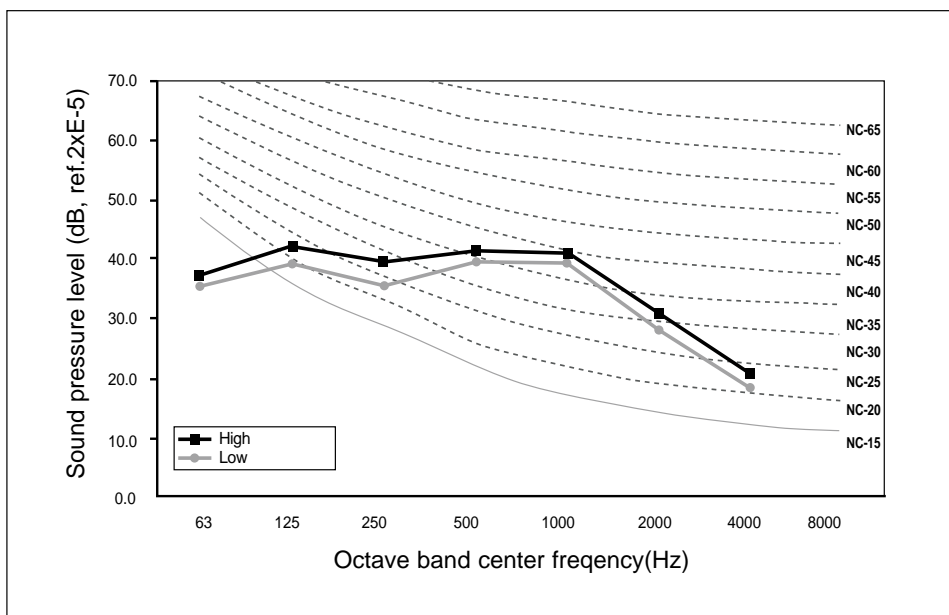



## 8. Noise level

**\*\*035/040\*\***

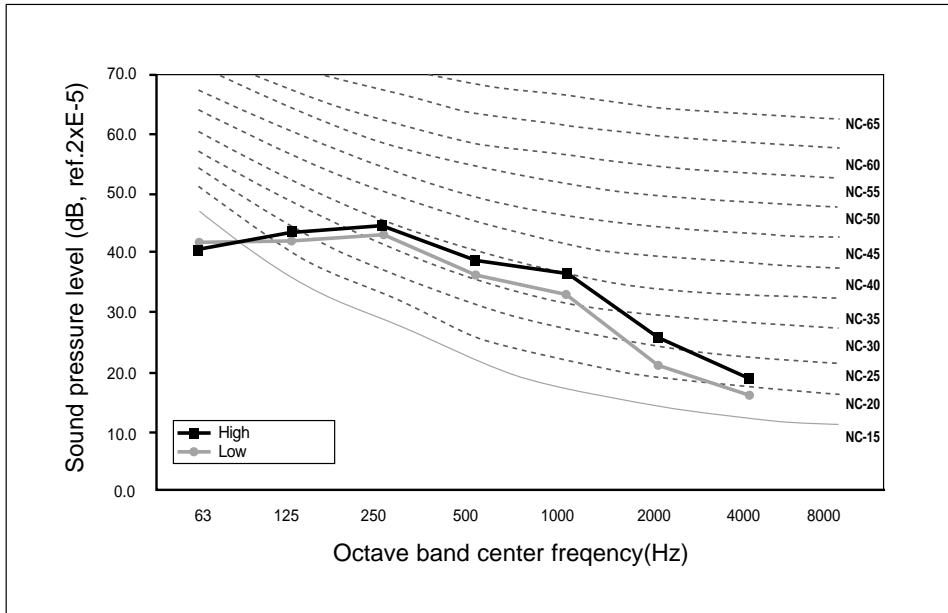

**(2) 4-way cassette type**

**\*\*052\*\***

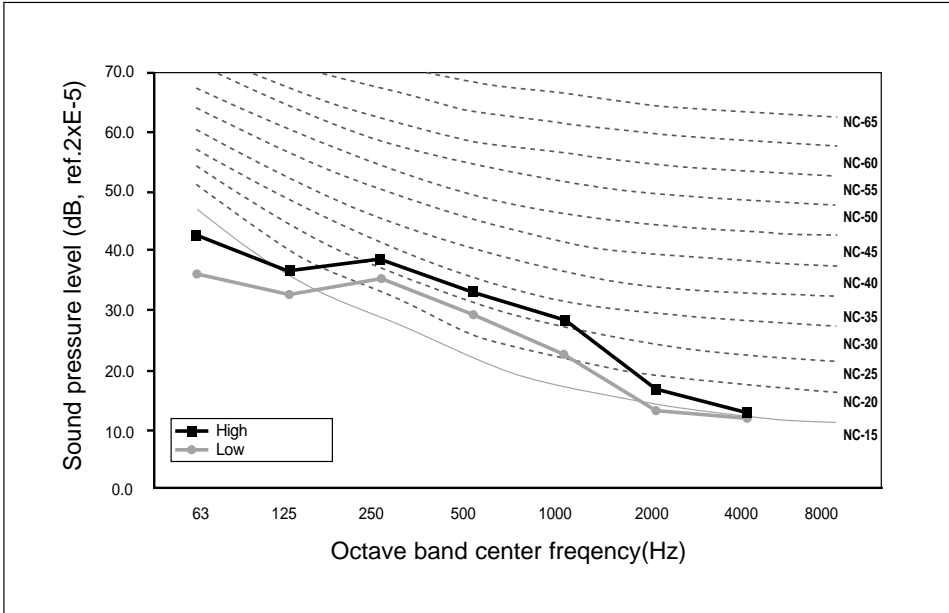

**\*\*070/072\*\***

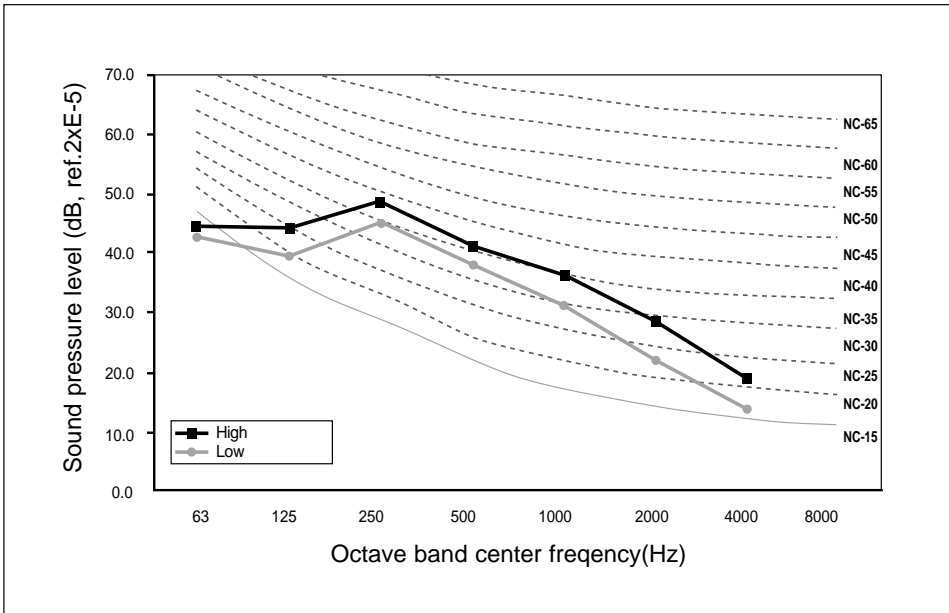



# 8. Noise level

**\*\*105\*\***

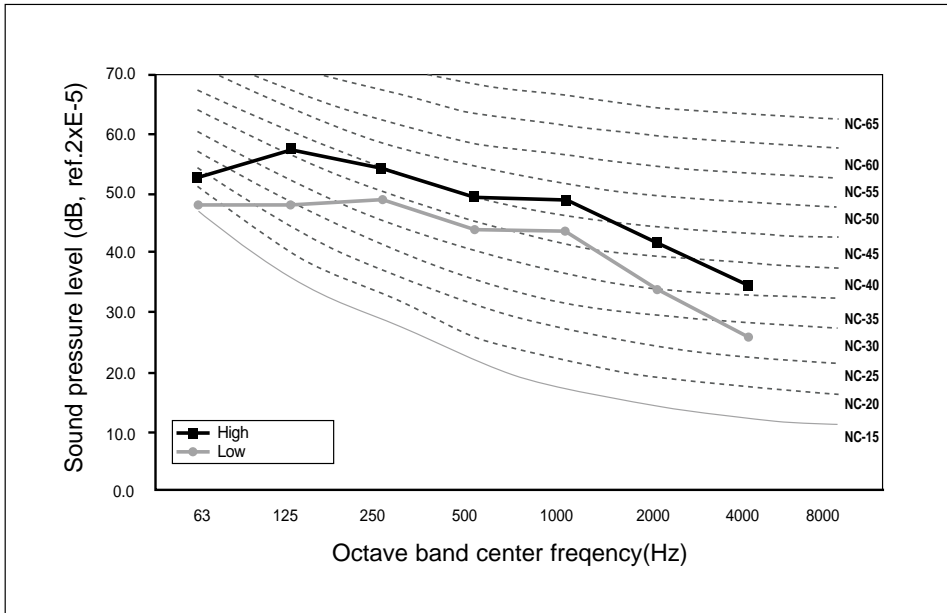

**(3) Duct type (Low silhouette)**

**\*\*052\*\***

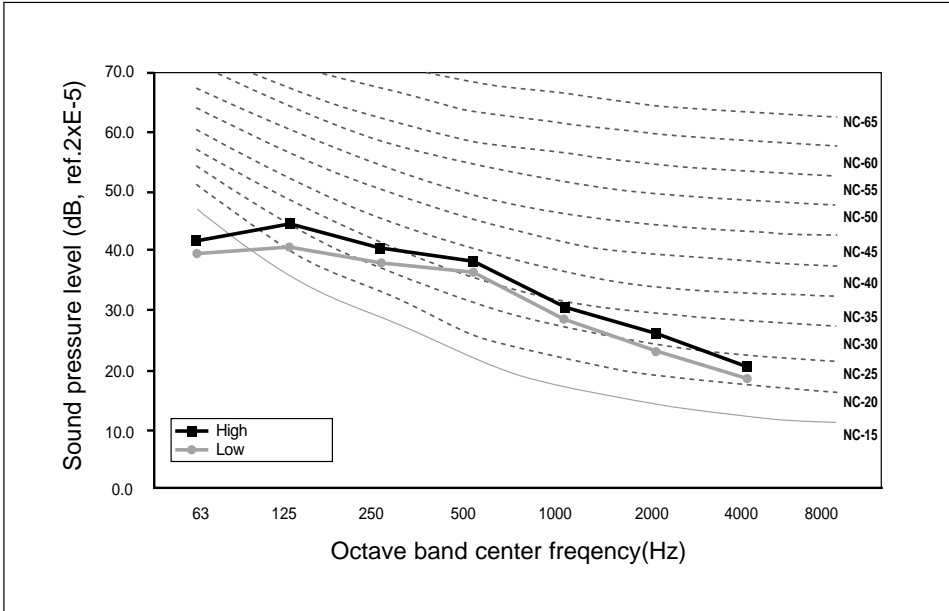

**\*\*070/072\*\***

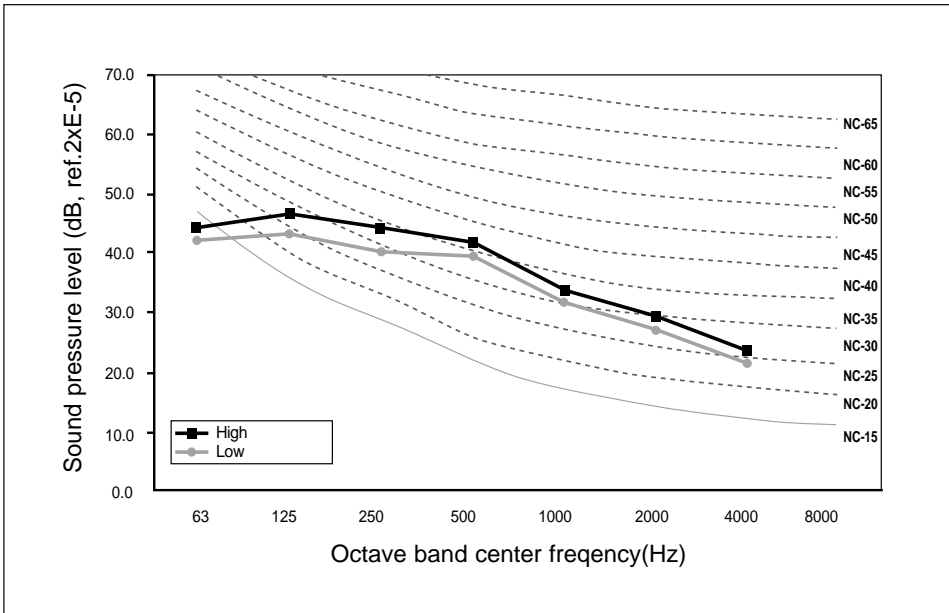



# 8. Noise level

## (4) Duct type (Built-in)

**\*\*020\*\***

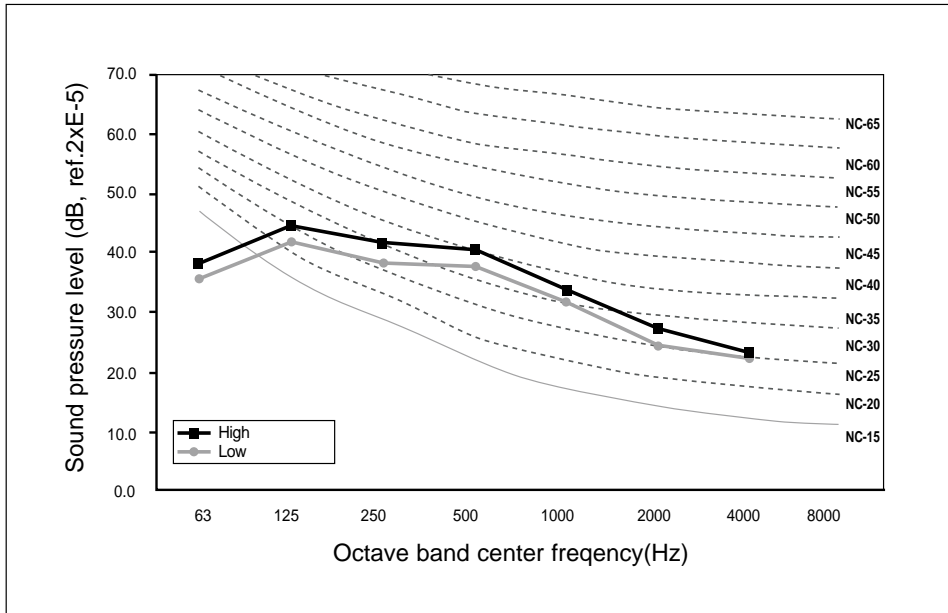

**\*\*026/032\*\***

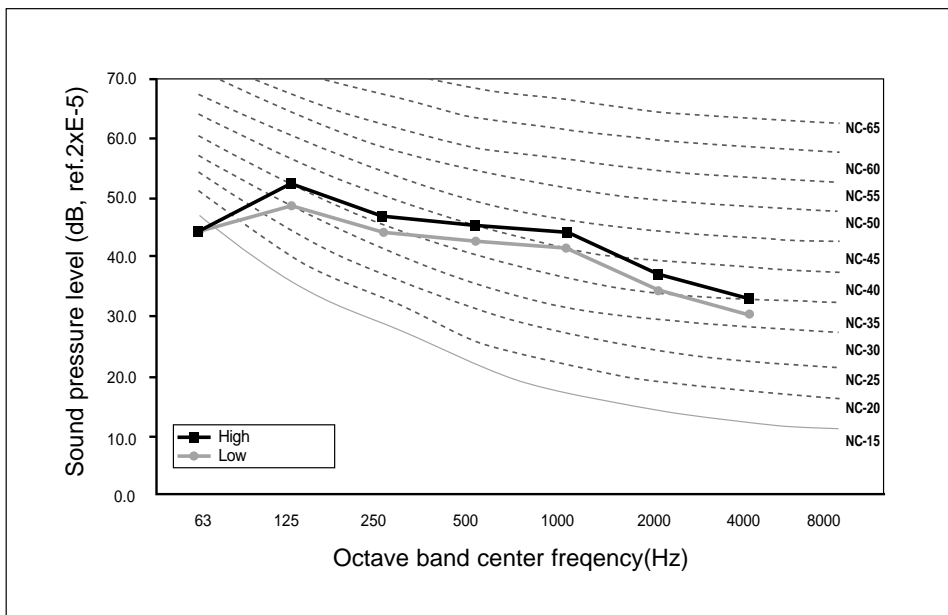



**\*\*035/040\*\***

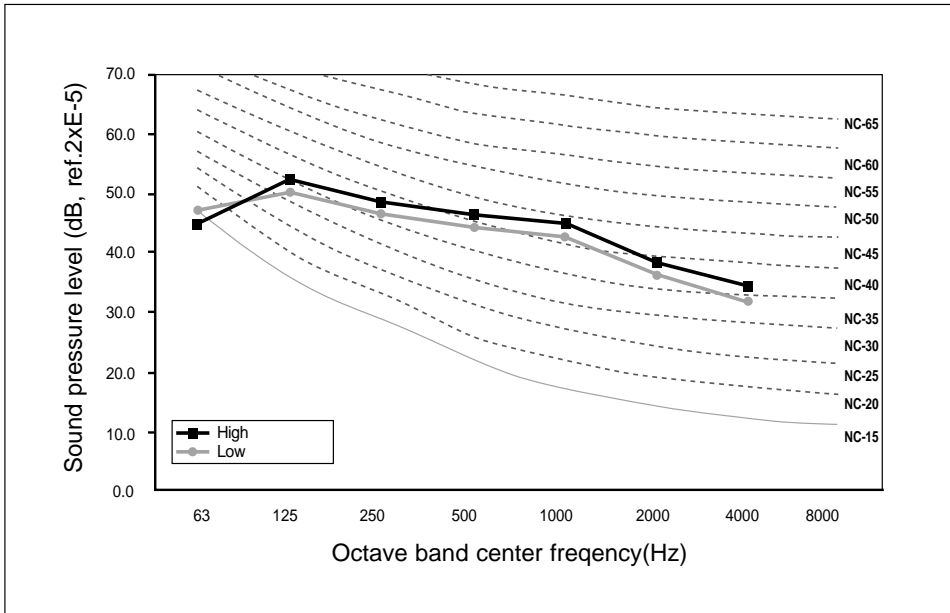

**\*\*052\*\***

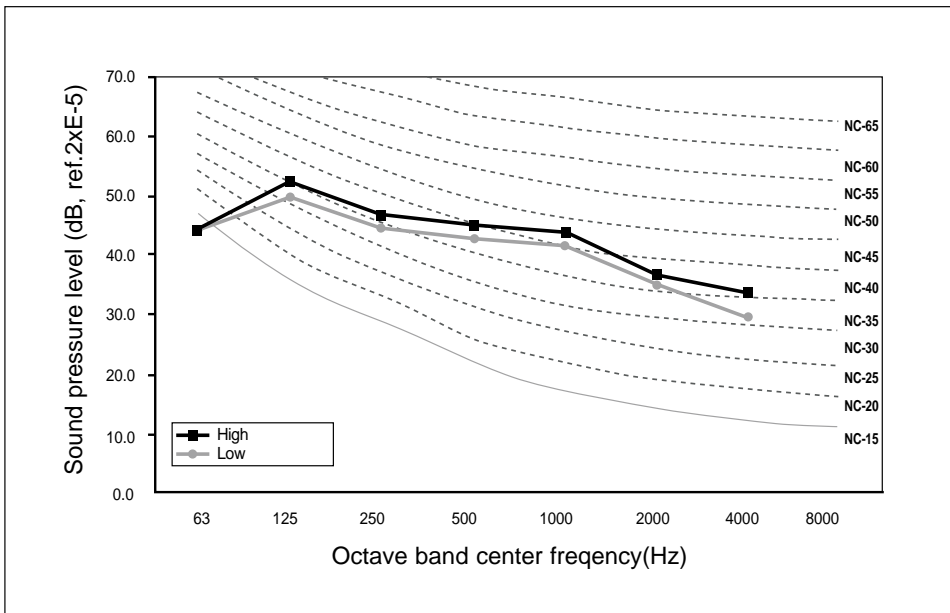



# 8. Noise level

**\*\*070/072\*\***

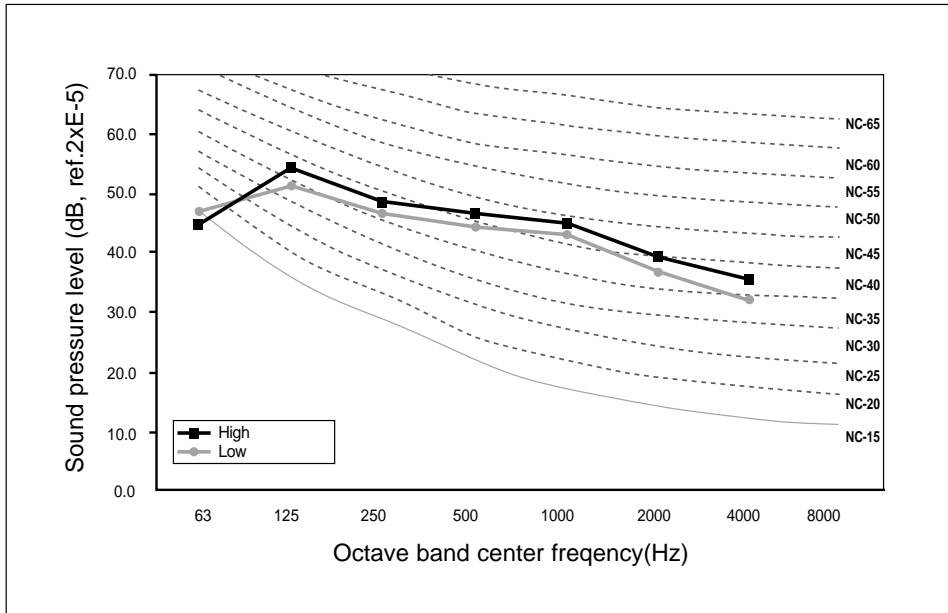

**(5) Duct type (High pressure)**

**\*\*105\*\***

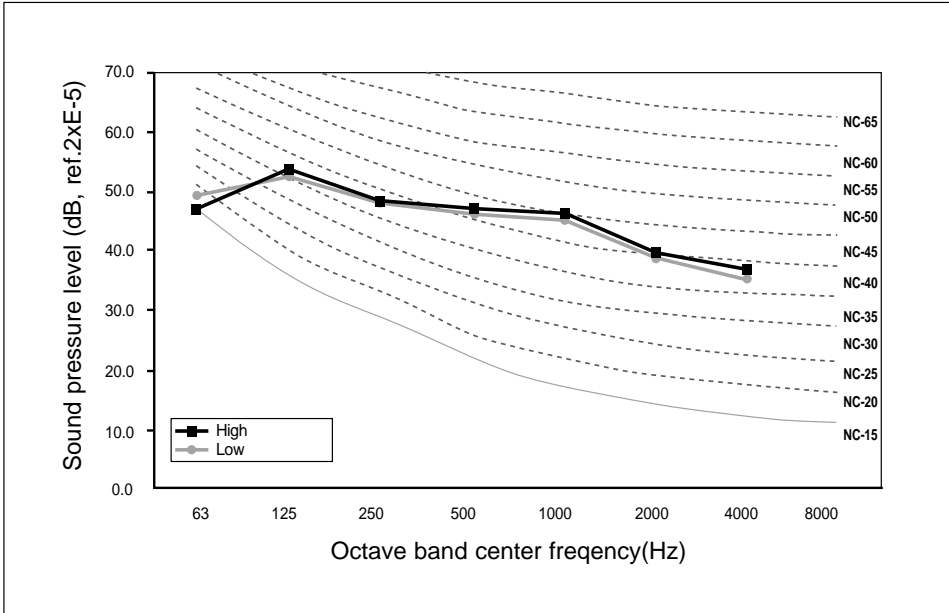

**\*\*128\*\***

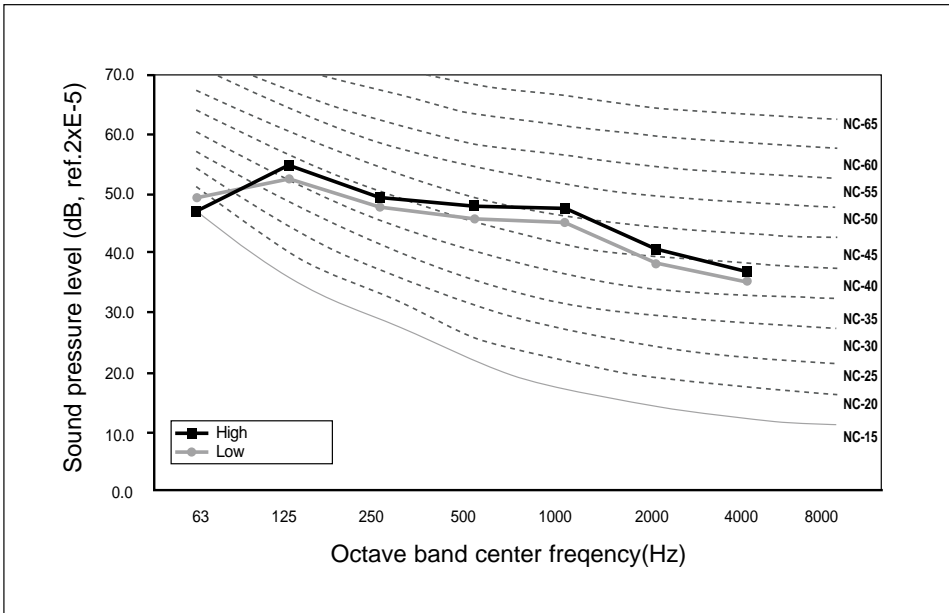



# 8. Noise level

## (6) Wall-mounted type

**\*\*020\*\***

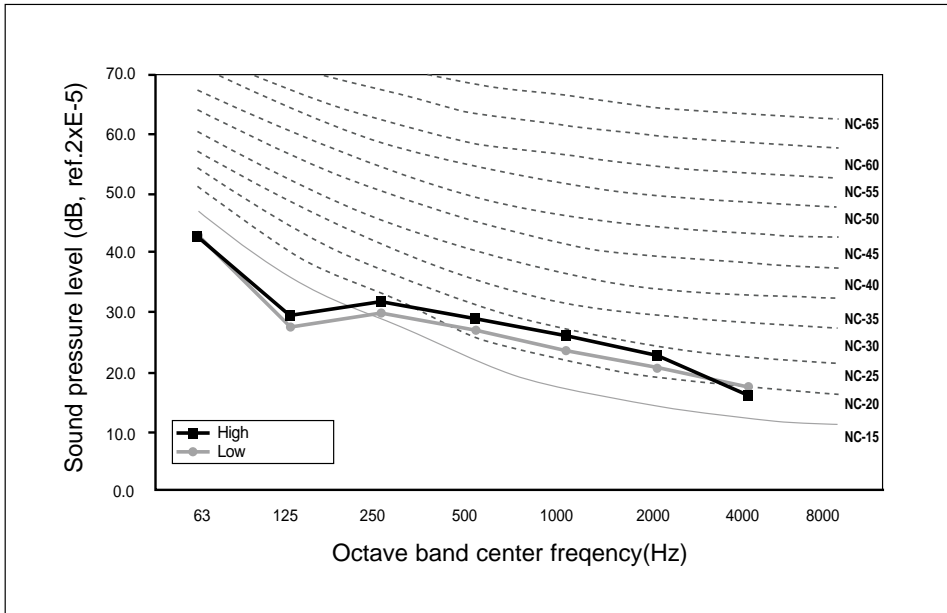

**\*\*026/032\*\***

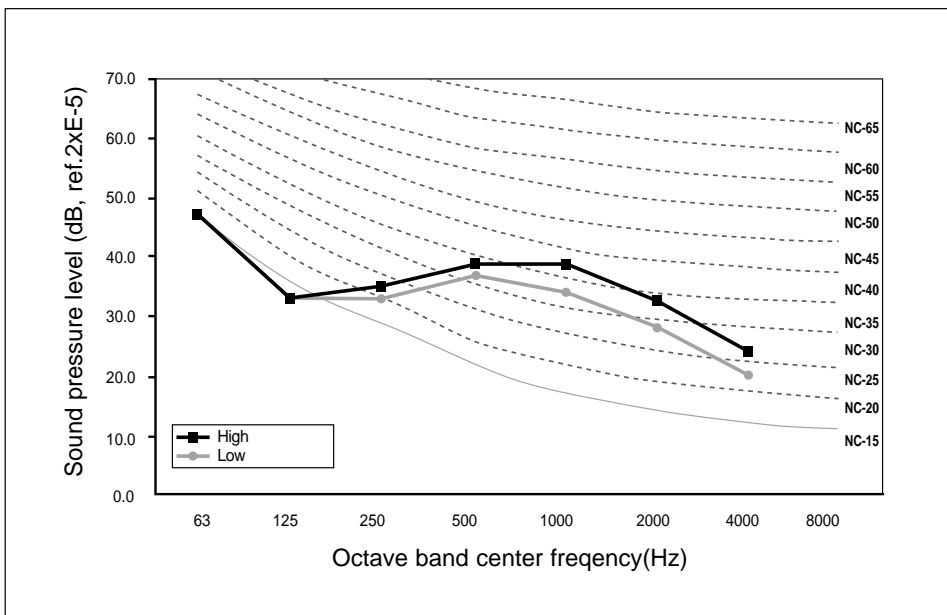

**\*\*035/040\*\***

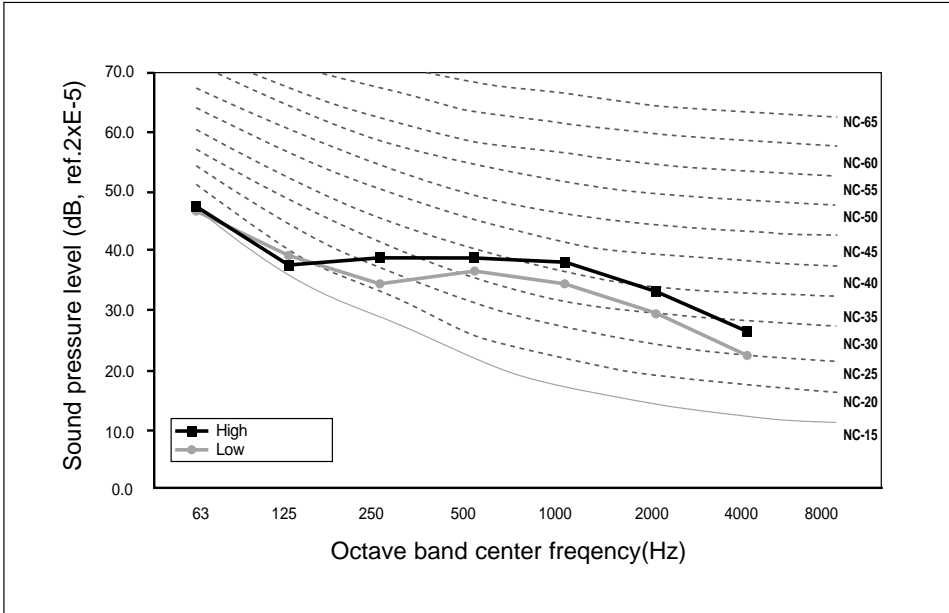

**\*\*052\*\***

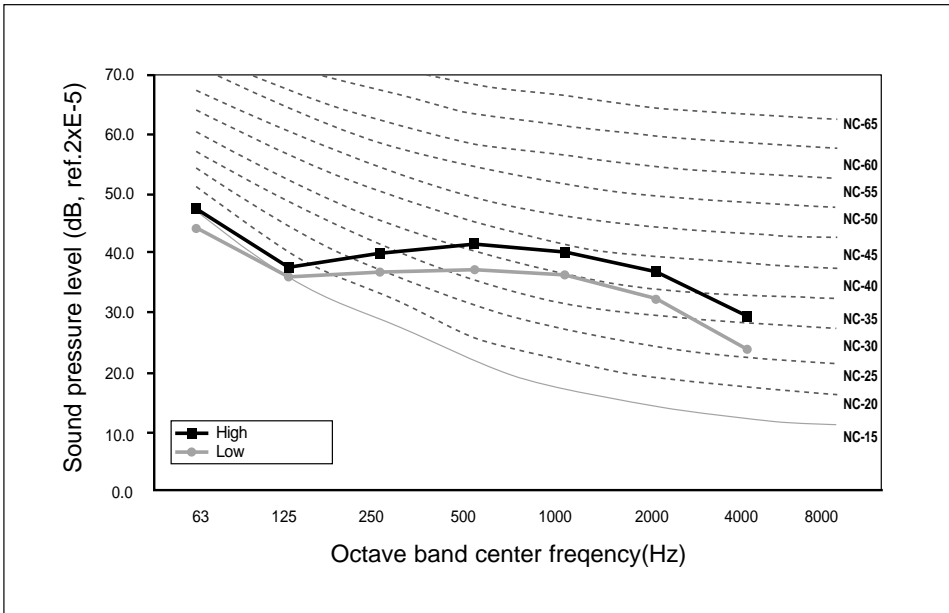



# 8. Noise level

**\*\*070/072\*\***

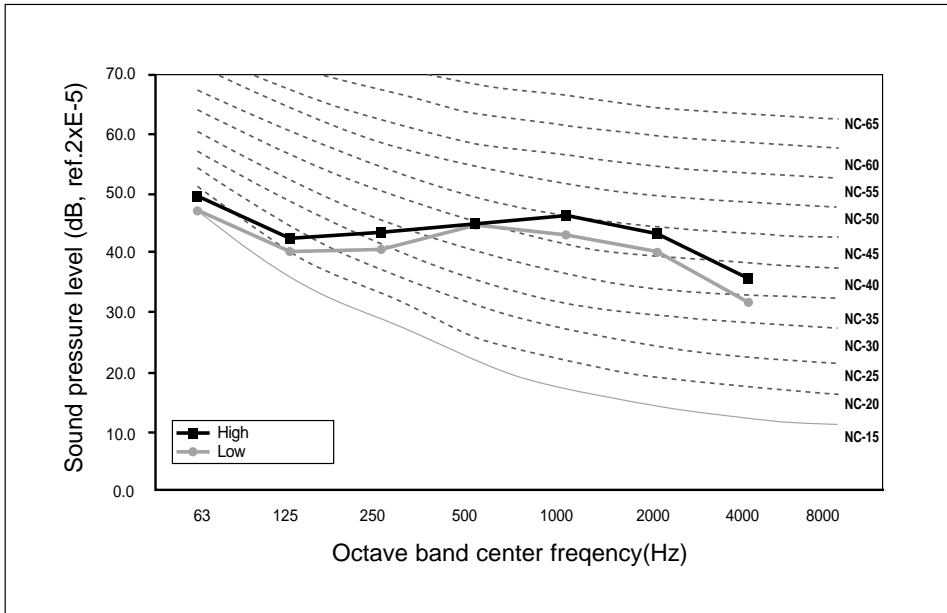

**(7) Floor standing type**

**\*\*060\*\***

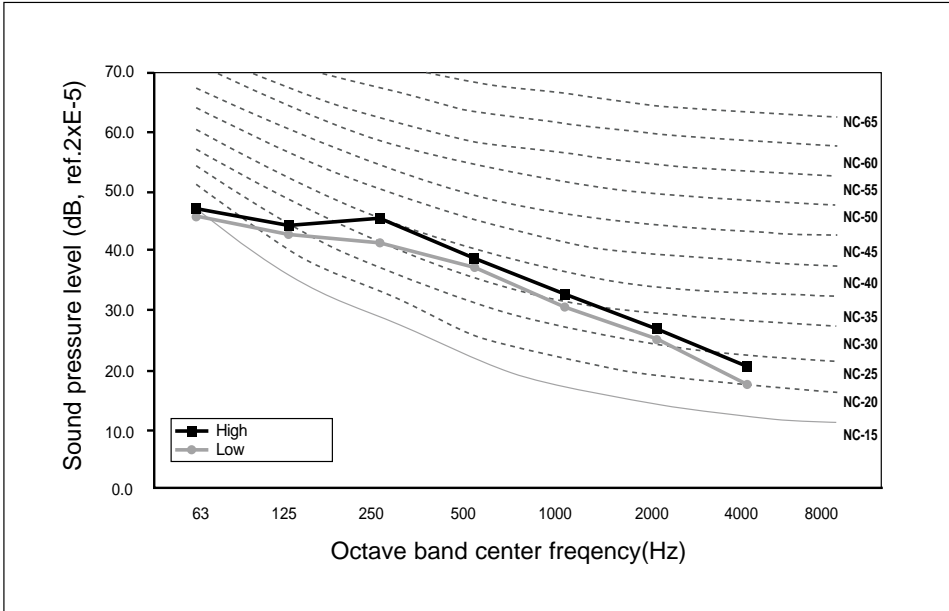

**\*\*070/072\*\***

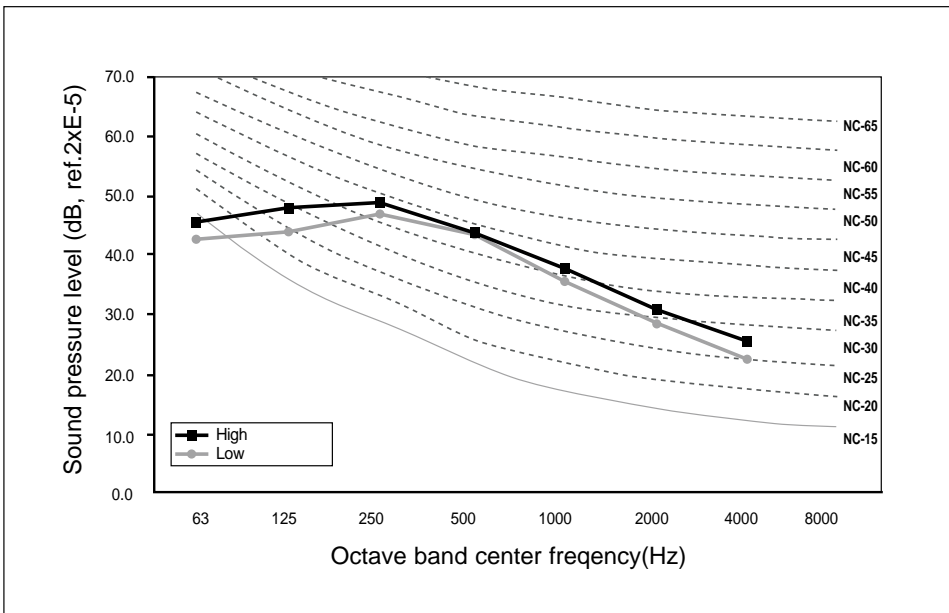



## 8. Noise level

**\*\*082/083\*\***

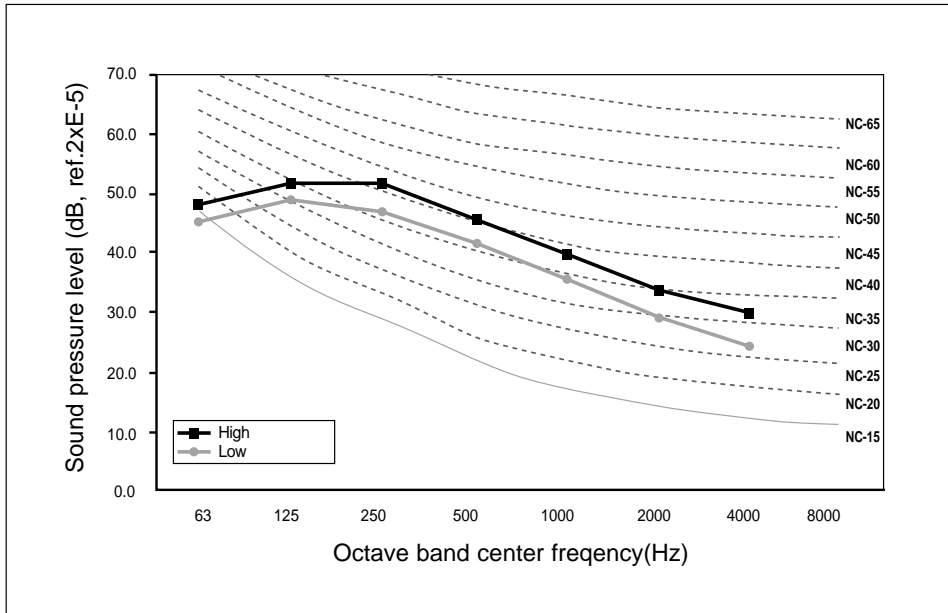



**(8) Ceiling type**

**\*\*052\*\***

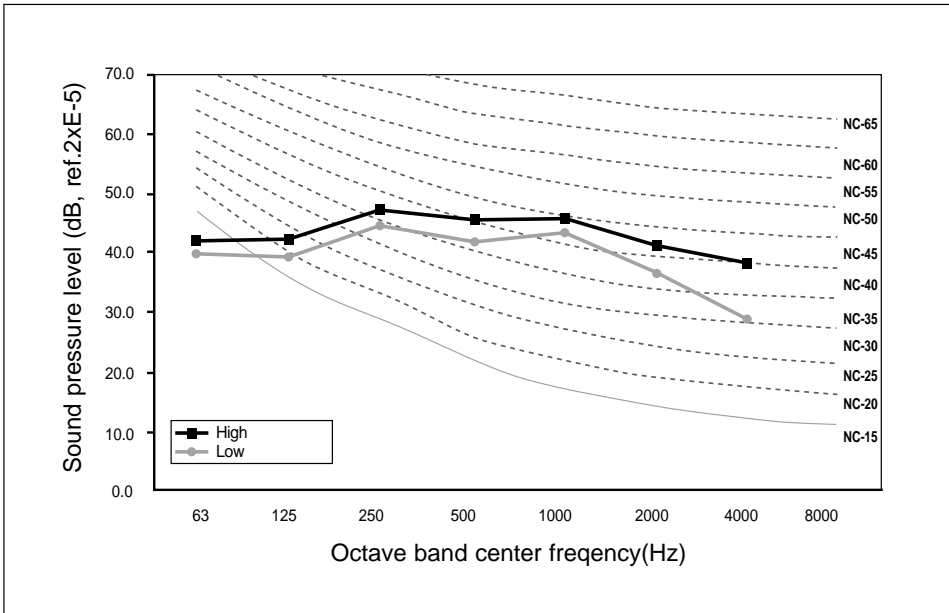

**\*\*070/072\*\***

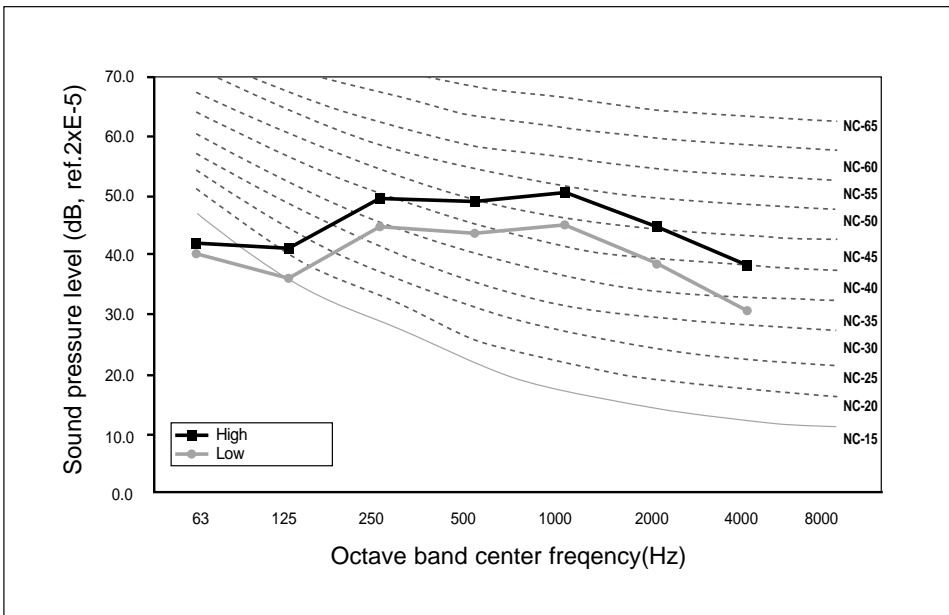



## 9. Velocity of air flow & temperature distribution

### 9-1. 1-way cassette type

#### (1) AVMKH035\*

##### 1) Velocity of air flow

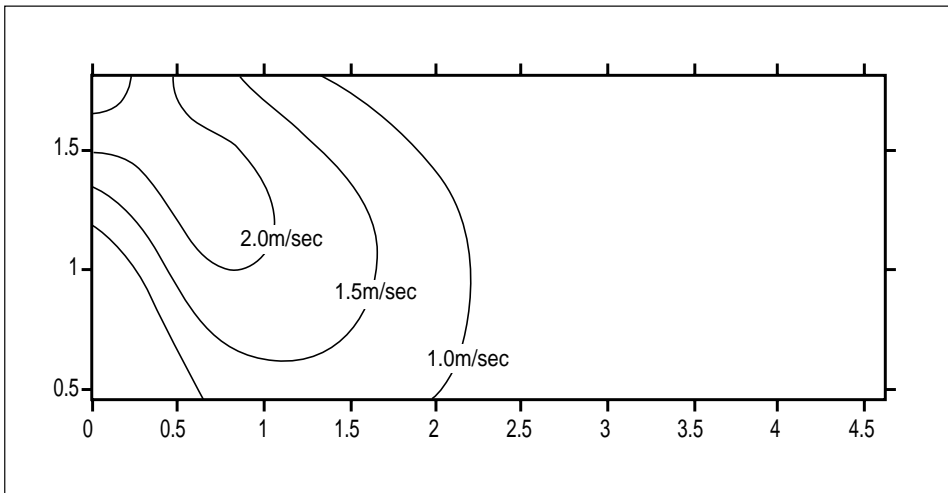

##### 2) Heating temperature distribution

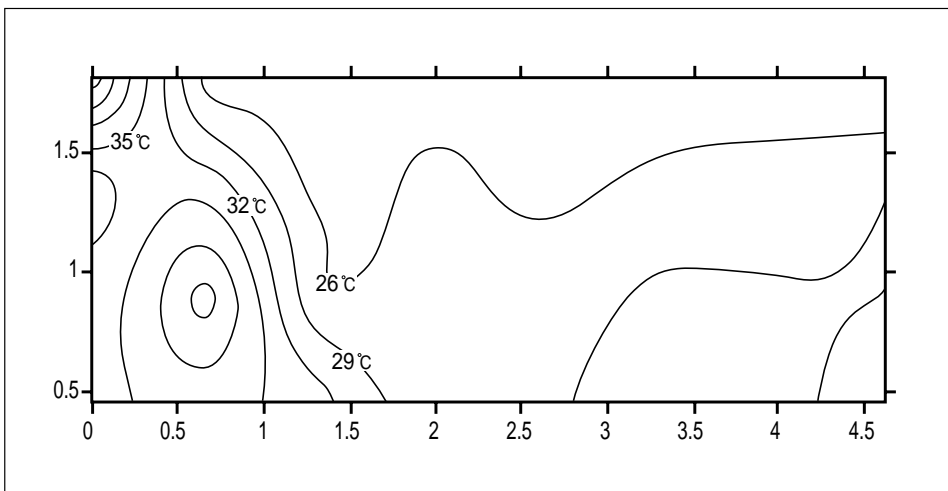

- Note**
- ◆ If a ceiling is high, you can apply a 1-way cassette type air conditioner.
  - ◆ The standard ceiling height is 3 meters and those values are tested at the standard height.

## 9-2. 4-way cassette type

### (1) AVMCH070\*

#### 1) Velocity of air flow

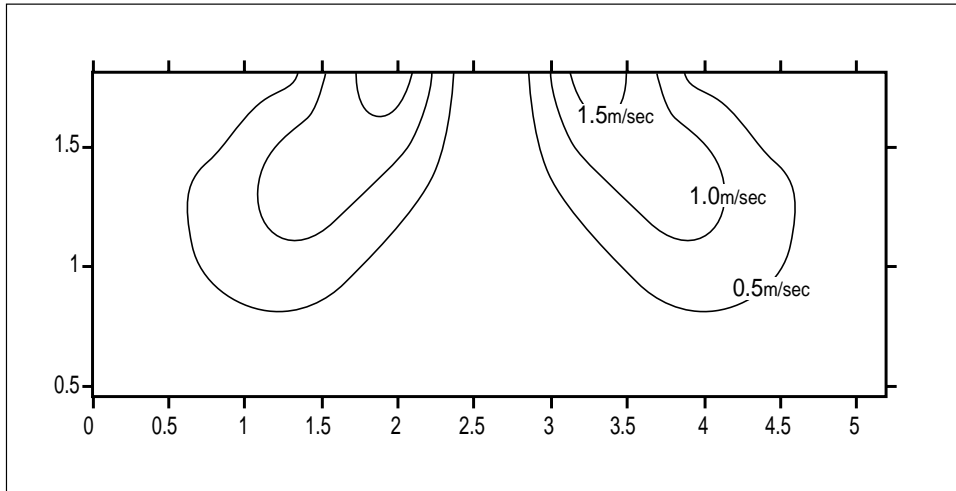

#### 2) Heating temperature distribution

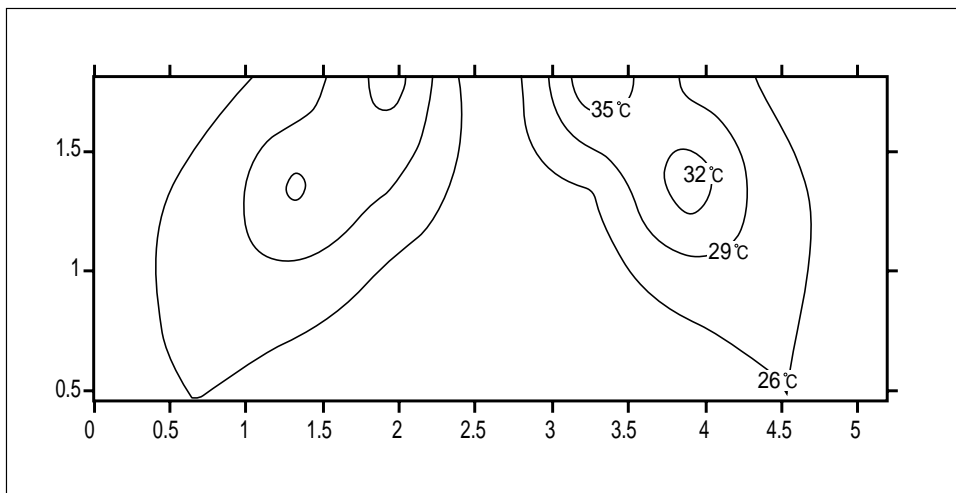

**Note** ◆ The standard ceiling height is 2.7 meters and those values are tested at the standard height.



## 9. Velocity of air flow & temperature distribution

### (2) AVMCH105\*

#### 1) Velocity of air flow

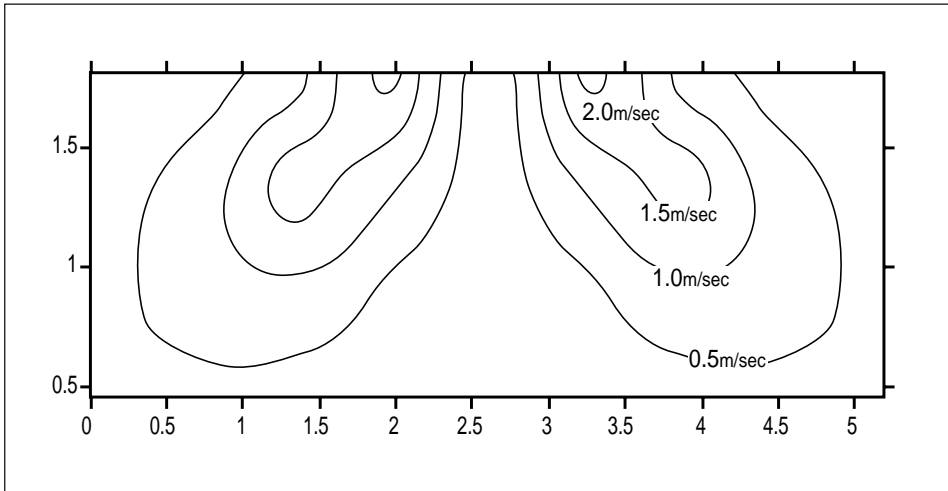

#### 2) Heating temperature distribution

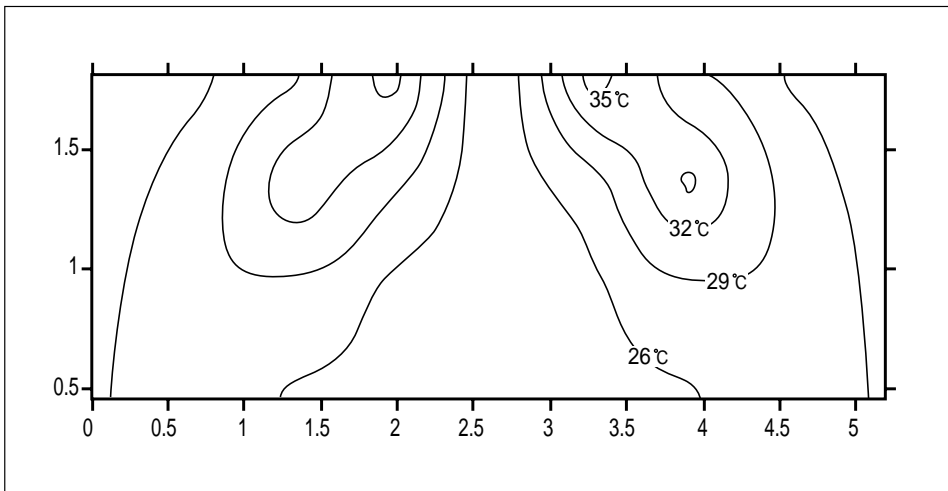

**Note** ◆ The standard ceiling height is 2.7 meters and those values are tested at the standard height.

## 9-3. Wall-mounted type

### (1) AVMWH035\*

#### 1) Velocity of air flow

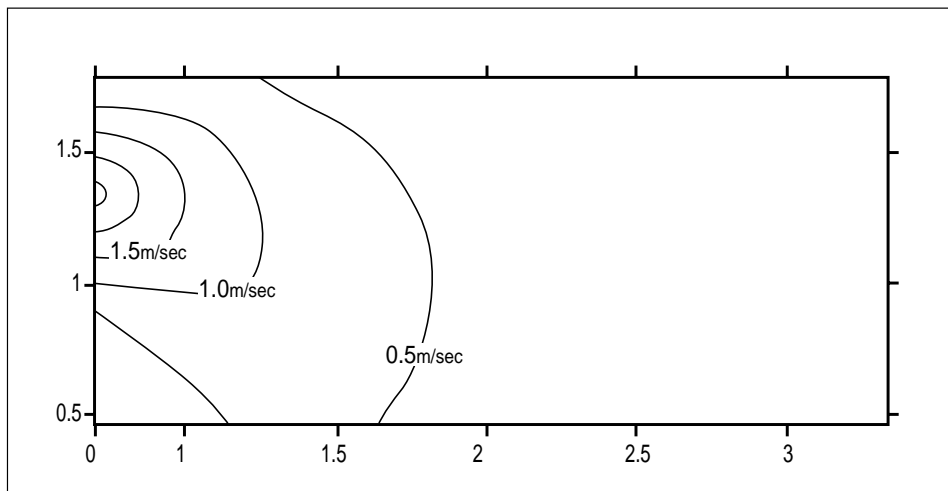

#### 2) Heating temperature distribution

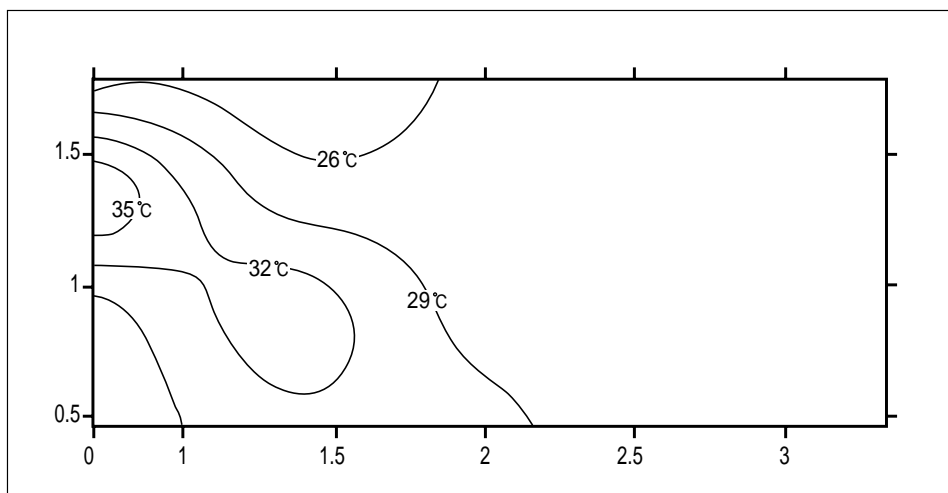

**Note** ◆ The standard ceiling height is 2.7 meters and those values are tested at the standard height.



## 9. Velocity of air flow & temperature distribution

### (2) AVMWH070\*

#### 1) Velocity of air flow

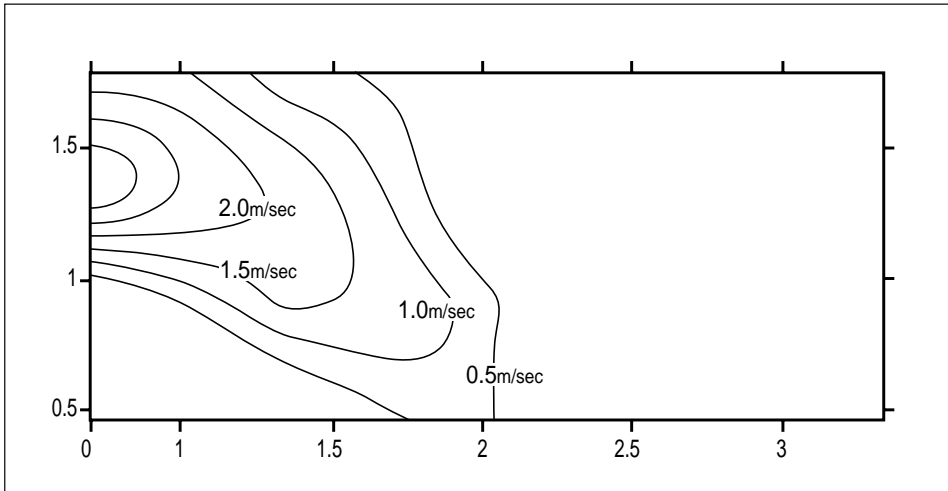

#### 2) Heating temperature distribution

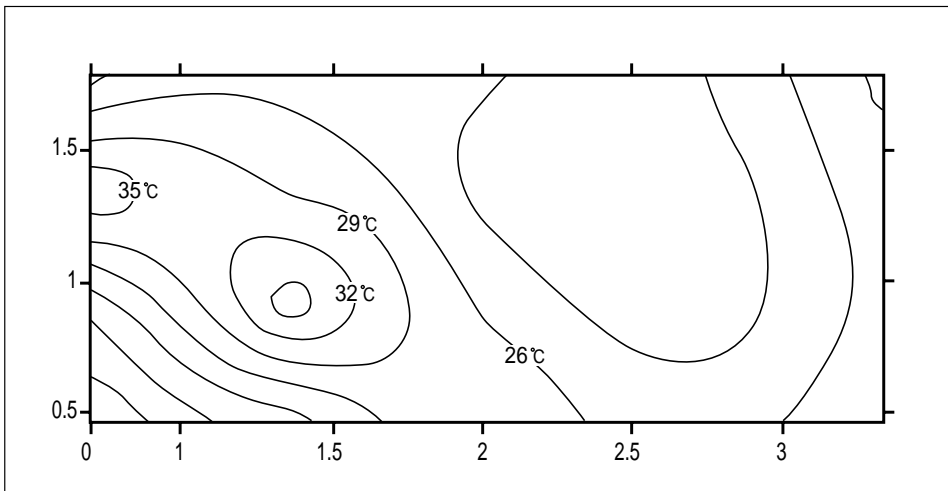

**Note** ◆ The standard ceiling height is 2.7 meters and those values are tested at the standard height.

## 9-4. Ceiling type

### (1) AVMFH070\*

#### 1) Velocity of air flow

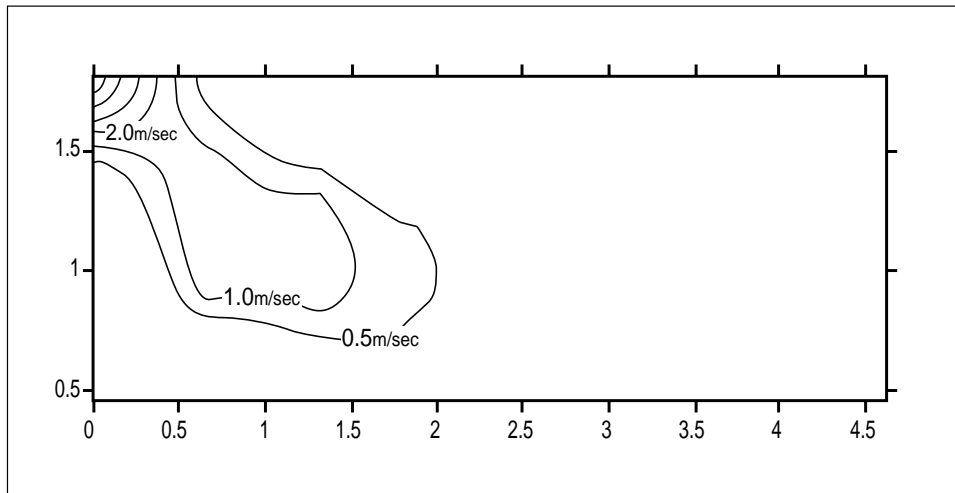

#### 2) Heating temperature distribution

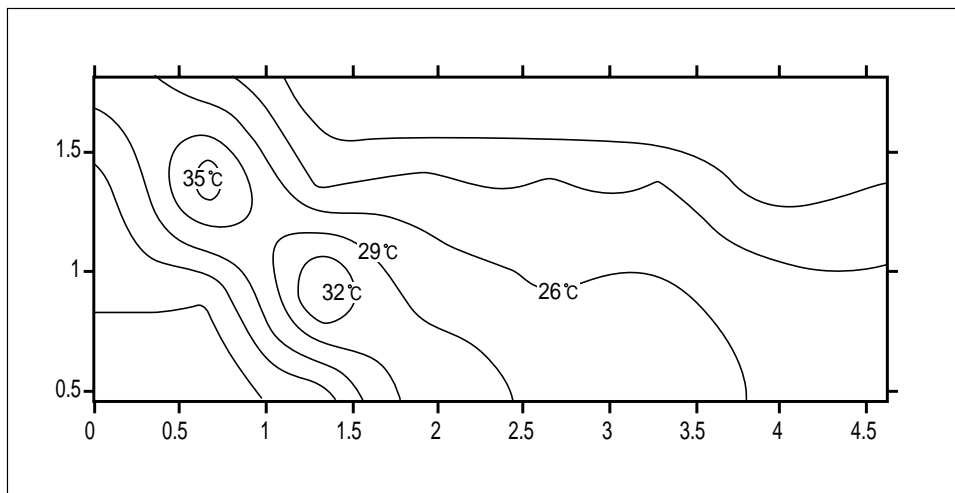

**Note** ◆ The standard ceiling height is 2.7 meters and those values are tested at the standard height.



# 10. Fan specifications

## 10-1. Duct type (Low silhouette)

(1) \*\*052\*\*

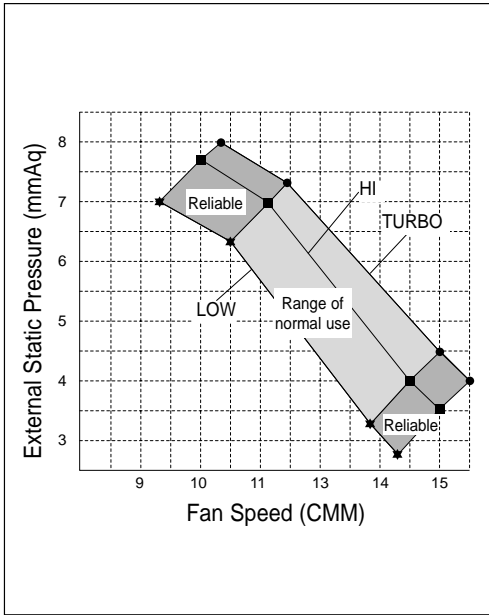

(2) \*\*070/072\*\*

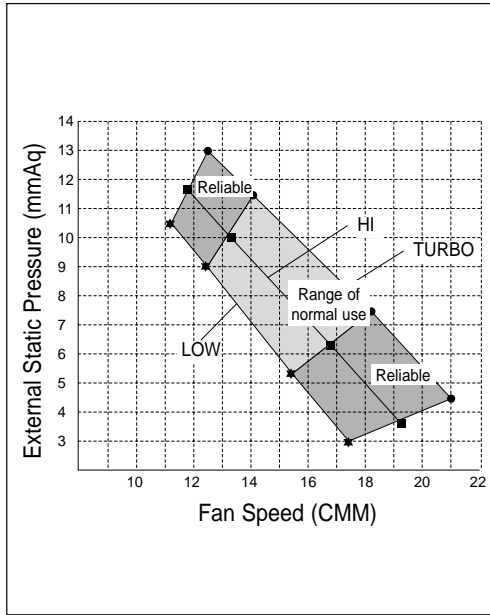

## 10-2. Duct type (Built-in)

(1) \*\*020\*\*

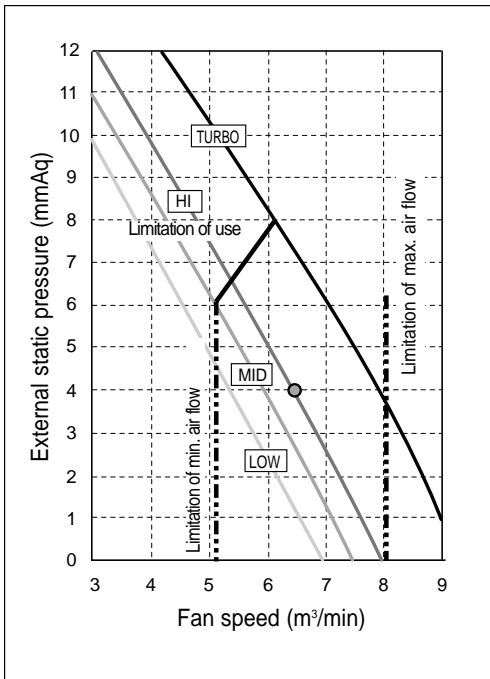

(2) \*\*026/032\*\*

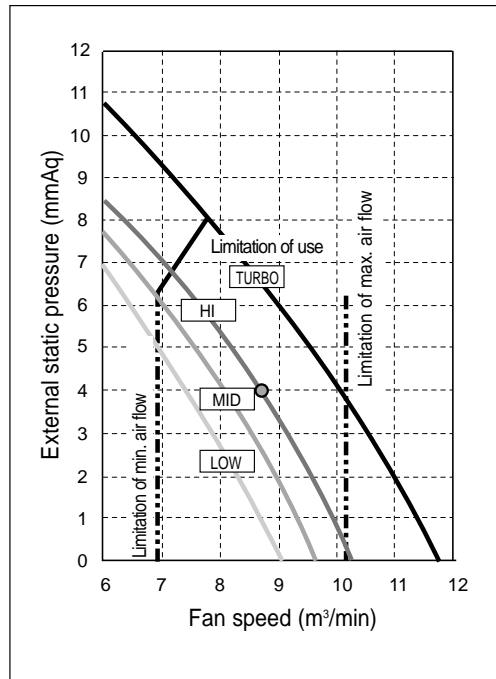



(3) \*\*035/040\*\*

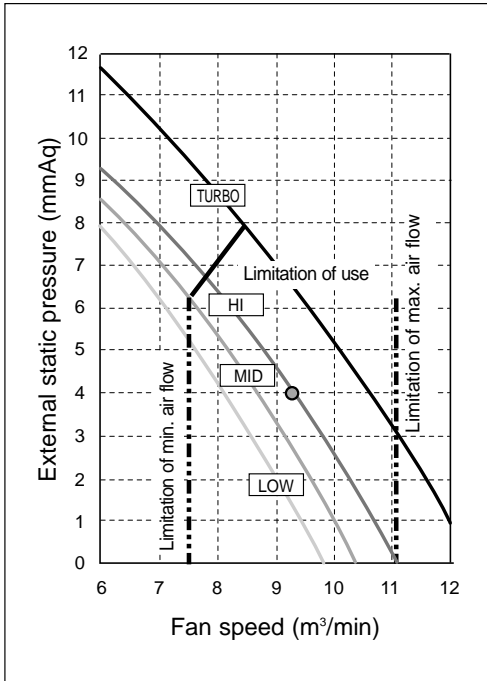

(4) \*\*026/032\*\*

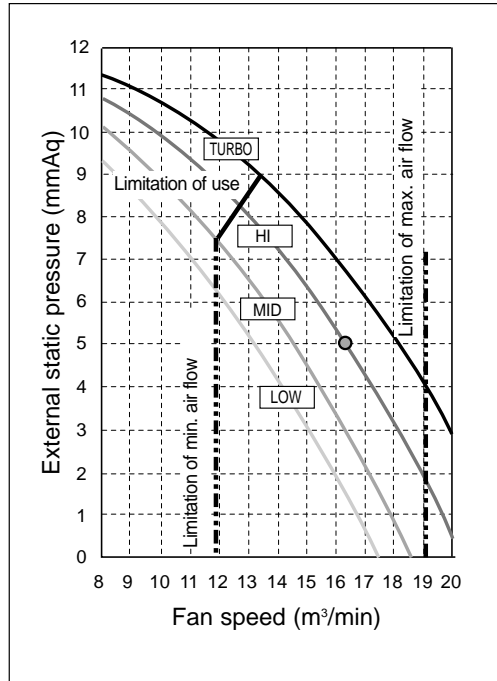

(5) \*\*070/072\*\*

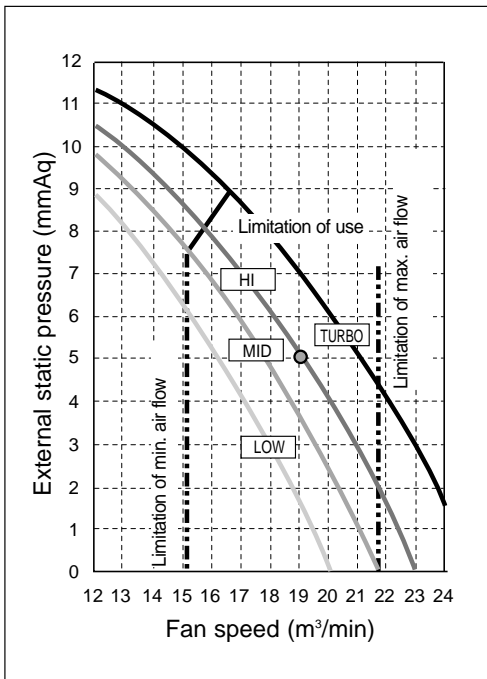



## 10. Fan specifications

### 10-3. Duct type (High pressure)

(1) \*\*105\*\*

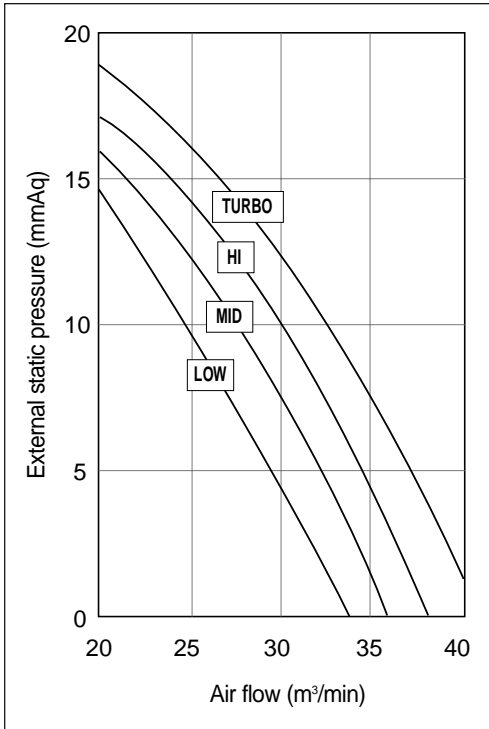

(2) \*\*128\*\*

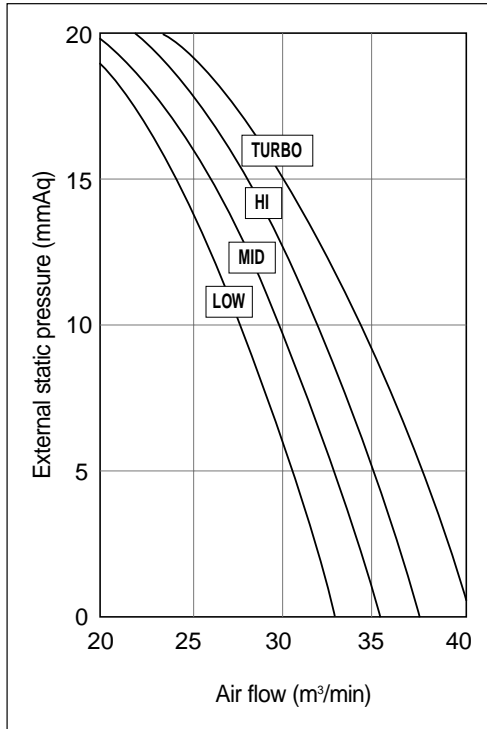

# 11. Panel

## 11-1. 1-way cassette type

### (1) Design

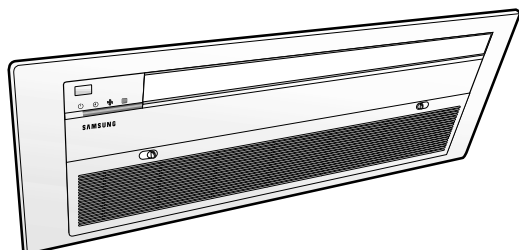

### (2) Status

Item	Model	Language
Cooling only	MGKC118IE0	English only
	MGKC118IM0	English, Spanish, Italian, Portuguese, French, German, Greek, Russian
	MGKC118IA0	English & Arabic
	MGKC118IC0	Chinese
Heat pump	MGKH118IE0	English only
	MGKH118IM0	English, Spanish, Italian, Portuguese, French, German, Greek, Russian
	MGKH118IA0	English & Arabic
	MGKH118IC0	Chinese



# 11. Panel

## 11-2. 4-way cassette type

### (1) Design

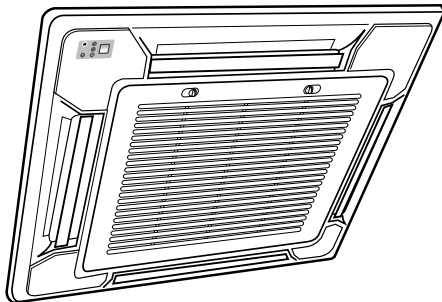

### (2) Status

Item	Model	Language
Cooling only	MGCC095IE0	English only
	MGCC095IM0	English, Spanish, Italian, Portuguese, French, German, Greek, Russian
	MGCC095IA0	English & Arabic
	MGCC095IC0	Chinese
Heat pump	MGCH095IE0	English only
	MGCH095IM0	English, Spanish, Italian, Portuguese, French, German, Greek, Russian
	MGCH095IA0	English & Arabic
	MGCH095IC0	Chinese

# 12. Electronic expansion valve kit

## 12-1. Design

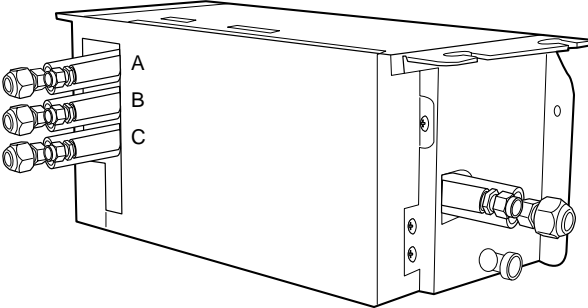

## 12-2. Status depending on the combination

Item	MEV-14			MEV-18		
	#1	#2	#3	#1	#2	#3
MXD14K300A	O	O	O			
MXD14K218A	O	O				O

◆ An electronic expansion valve can be applied to 1~3 indoor units. If you want to install more indoor units, separate it properly.



# 13. Options

Item		Mandatory items			Drain pump	
		Panel	Electronic expansion valve kit	Remote controller		
1-way cassette type	C/O	O	O	O	Integrated	
	H/P	O	O	O	Integrated	
4-way cassette type	C/O	O	Integrated	O	Integrated	
	H/P	O	Integrated	O	Integrated	
Duct type	Low silhouette	C/O	-	Integrated	O	
		H/P	-	Integrated	O	
	Built-in	C/O	-	Integrated	O	O
		H/P	-	Integrated	O	O
	High pressure	C/O	-	Integrated	O	O
		H/P	-	Integrated	O	O
Wall-mounted type	C/O	-	O	O	-	
	H/P	-	O	O	-	
Floor standing type	C/O	-	O	O	-	
	H/P	-	O	O	-	
Ceiling type	C/O	-	O	O	-	
	H/P	-	O	O	-	

- Note**
- ◆ For specifications of panel and electronic expansion valve, refer to pages 111~113 at this chapter.
  - ◆ In case of the wireless remote controller, which is the option for duct type, wireless remote controller, receiver & display unit wire and receiver & display unit should be purchased together.

Item		Optional items						Fresh air intake	
		Drain pump	Wireless remote controller	Receiver & display unit wire	Receiver & display unit (Concealed type)	Receiver & display unit (Standard type)	Wired remote controller		
1-way cassette type	C/O	-	MR-AC01	-	-	-	MWR-AC01	X	
	H/P	-	MR-AH01	-	-	-	MWR-AH01	X	
4-way cassette type	C/O	-	MR-AC01	-	-	-	MWR-AC01	X	
	H/P	-	MR-AH01	-	-	-	MWR-AH01	X	
Duct type	Low silhouette	C/O	MDP-075SA	MR-AC00	MRW-10A	MRK-B00	MRK-A00	MWR-AC00	O
		H/P	MDP-075SA	MR-AH00	MRW-10A	MRK-B00	MRK-A00	MWR-AH00	O
	Built-in	C/O	MDP-075SA	MR-AC00	MRW-10A	MRK-B00	MRK-A00	MWR-AC00	O
		H/P	MDP-075SA	MR-AH00	MRW-10A	MRK-B00	MRK-A00	MWR-AH00	O
	High pressure	C/O	MDP-075SA	MR-AC00	MRW-10A	MRK-B00	MRK-A00	MWR-AC00	O
		H/P	MDP-075SA	MR-AH00	MRW-10A	MRK-B00	MRK-A00	MWR-AH00	O
Wall-mounted type	C/O	-	MR-AC01	-	-	-	MWR-AC01	X	
	H/P	-	MR-AH01	-	-	-	MWR-AH01	X	
Floor standing type	C/O	-	MR-AC01	-	-	-	MWR-AC01	X	
	H/P	-	MR-AH01	-	-	-	MWR-AH01	X	
Ceiling type	C/O	-	MR-AC01	-	-	-	MWR-AC01	X	
	H/P	-	MR-AH01	-	-	-	MWR-AH01	X	

- Note**
- ◆ For specifications of panel and electronic expansion valve, refer to pages 111~113 at this chapter.
  - ◆ In case of the wireless remote controller, which is the option for duct type, wireless remote controller, receiver & display unit wire and receiver & display unit should be purchased together.





# IV Outdoor unit

1	Selection of outdoor units (based on cooling load)	
2	Specification	
	2-1. 50Hz .....	4
	2-2. 60Hz .....	6
3	Functional parts and safety devices	
	3-1. Outdoor unit .....	8
	3-2. Super cooler .....	13
4	Capacity table	
	4-1. 50Hz .....	14
	4-2. 60Hz .....	20
5	Dimension	
	5-1. Upward (2-FAN) .....	31
	5-2. Onward .....	32
	5-3. Upward (1-FAN) .....	33
	5-4. Upward (Super cooler) .....	34
6	Refrigerant system diagram	
	6-1. Cooling .....	35
	6-2. Heating .....	38
7	Electric circuit diagram	
	7-1. Cooling only .....	42
	7-2. Heat pump .....	44
8	Consideration for outdoor unit selection	
	8-1. Change of capacity depending on refrigerant piping length .....	45
	8-2. Condition of operating restriction .....	46
9	Noise level	
10	Options	



# 1. Unit selection (with cooling load)

## 1-1. Indoor unit selection

Select the nearest load capacity indoor unit with given load after finding indoor and outdoor temperature using indoor unit capacity table. (The indoor unit capacity should larger than given load.)



◆ The described capacity may be different to each indoor unit according to combination. So, the real capacity should be calculated with outdoor unit capacity table.

## 1-2. Outdoor unit selection

The allowable combination is described on the indoor unit combination total capacity index table.

For the standard of indoor unit and outdoor unit combination, select the nearest value that the total indoor unit capacity index is less than a 100% outdoor unit combination capacity index.

### ■ Indoor unit combination total capacity index

outdoor unit	indoor unit combination rate					
	100%	90%	80%	70%	60%	50%
RVMH060GBM0	160	144	128	112	96	80
RVMH100GBM0	280	252	224	196	168	140
RVMH100FAM0	280(ISO)	252	224	196	168	140

### ■ Indoor unit capacity index

- 50Hz

Unit size	020	026	035	052	070	105	128
capacity index	20.0	26.0	35.0	52.0	70.0	105.0	128.0

- 60Hz

Unit size	020	032	040	052	072	083	105	128
capacity index	20.0	32.0	40.0	52.0	72.0	83.0	105.0	128.0

## 1-3. Real function data

- (1) Select the exact table according to outdoor unit model and combination rate using outdoor unit capacity table. According to given indoor and outdoor temperature, find outdoor unit capacity and power input using the table. Each indoor unit capacity (power input) is calculated as follow.**

$$IUC = AUC \times INX / TNX$$

IUC: Each indoor unit capacity (power input)

OUC: Outdoor unit capacity (power input)

INX: Each indoor unit capacity index

TNX: Total capacity index

- (2) According to pipe length, change the indoor unit capacity. If the changed capacity is smaller than load, change it to larger capacity indoor unit and repeat the selecting progress.**

## 1-4. Example for unit selection with cooling load

### (1) Given condition

- 1) Design condition <Cooling: Indoor 20°C(WB), Outdoor 33°C(DB)>
- 2) Cooling load

Location	Room A	Room B	Room C	Room D	Room E	Room F
Load (kW)	2.4	2.8	3.2	3.4	4.8	7.2

- 3) Power supply unit: 3 Phase 380V 50Hz
- 4) Pipe length: 30m

### (2) Indoor unit selection

Select the suitable capacity for condition of 'Indoor 20°C(WB), Outdoor 33°C(DB)' using indoor unit capacity table. The selected result is as follow.

Location	Room A	Room B	Room C	Room D	Room E	Room F
Load (kW)	2.4	2.8	3.2	3.4	4.8	7.2
Unit size	26	26	35	35	52	70
Capacity(kW)	2.8	2.8	3.77	3.77	5.6	7.54

### (3) Outdoor unit selection

- 1) Assume the indoor unit and outdoor unit combination as follow.

Outdoor unit: RVMH100GBM0

Indoor unit: AVMKH026EA0 x 2,AVMKH035EA0 x 2,AVMCH052EA0 x 1,AVMCH070EA0 x 1

- 2) Indoor unit combination total capacity index

$$26 \times 2 + 35 \times 2 + 52 \times 1 + 70 \times 1 = 244, (244/280) \times 100\% = 87\%$$

- 3) Result: Because it is within 50~100%, it is 'Right' selection.

### (4) Real function data with indoor unit combination

- 1) For the 87% combination, calculate the cooling capacity of outdoor unit (RVMH100GBM0).

27.14kW ← 90% (Indoor temperature: WB 20°C, Outdoor temperature: DB 33°C)

24.12kW ← 80% (Indoor temperature: WB 20°C, Outdoor temperature: DB 33°C)

Therefore,  $26.23 = 24.12 + ((27.14 - 24.12)/10) \times 7$ : Calculated in 87%

- 2) Outdoor unit (RVMH100GBM0) cooling capacity: 26.23kW ← 87%

(Indoor temperature: WB 20°C, Outdoor temperature: DB 33°C)

- 3) Capacity change factor with pipe length (30m): 0.95(30m).

- 4) Each cooling capacity

AVMKH026EA0:  $26.23 \times 2/244 \times 0.95 = 2.66(\text{kW})$

AVMKH035EA0:  $26.23 \times 35/244 \times 0.95 = 3.57(\text{kW})$

AVMCH052EA0:  $26.23 \times 52/244 \times 0.95 = 5.31(\text{kW})$

AVMCH070EA0:  $26.23 \times 70/244 \times 0.95 = 7.15(\text{kW})$

Location	Room A	Room B	Room C	Room D	Room E	Room F
Load (kW)	2.4	2.8	3.2	3.4	4.8	7.1
Unit size	26	26	35	35	52	70
Capacity(kW)	2.66	2.66	3.57	3.57	5.31	7.15



## 2. Specification

### 2-1. 50Hz

Model				RVMC060GAM0 RVMC060GAM1	RVMC060GDM0	RVMC100GAM0	
Power supply			ø, V, Hz	3, 380-415, 50	3, 380-415, 50	3, 380-415, 50	
Remark				Cooling only			
				Set	Set	Set	
Performance	Capacity	Cooling * 1)	Btu/h	55000(7000-55000)	55000(7000-55000)	95500(7000-95500)	
			kW	16.0(2.0-16.0)	16.0(2.0-16.0)	28.0(2.0-28.0)	
		Heating * 2)	Btu/h	-	-	-	
			kW	-	-	-	
	Sound Level (Front View) * 3)	Cooling	dB	54	57	59	
		Heating	dB	-	-	-	
Power	Compressor	Model	-	ZRD72KC-TFD	ZRD72KCE-TFD	ZRDT14MC-TFD	
		Type	-	Digital scroll	Digital scroll	Digital scroll +Fixed scroll Fixed scroll	
		Piston displacement	cc/Rev	98.04	98.04	98.04+98.04	
		Output	kW	4.2	4.2	4.2+4.2	
	Fan output	Type	-	Propeller	Propeller	Propeller	
		Output	Watt	128 x 2	128 x 2	450	
		Air flow rate	m <sup>3</sup> /min	90	95	150	
	Running current	Cooling	A	8.0(4.5-8.0)	10.5	20(5.8-20)	
		Heating	A	-	-	-	
	Power input	Cooling	Watt	5255(1865-5255)	6200	11000(2300-11000)	
		Heating	Watt	-	-	-	
	Others	Design pressure		Mpa	2.9	2.9	2.9
		Refrigerant	Name	-	R-22	R407C	R-22
			Charge	kg	9	8.0	14
Control			-	EEV	EEV	EEV	
Refrigerant oil		Name	-	Sontex 200LT	POE	Sontex 200LT	
		Charge	cc	1890	1890	1890 x 2	
Connecting pipe		Liquid	mm	12.70	9.52	12.70	
		Gas	mm	25.40	22.20	28.60	
		Drain	mm	-	-	-	
Size		Net weight		kg	178	142	300
	Shipping weight		kg	186	158	310	
	Net dimension (WxHxD)		mm	1170x1090x600	930x1270x385	990x1765x780	
	Shipping dimension(Carton/Case) (WxHxD)		mm	1237x1225x685	1124x1404x509	1084x2090x984	
Function / Option	Temperature range (Outdoor)	Cooling	°C	-5 to 54	-5 to 43	-5 to 54	
		Heating	°C	-	-	-	
	Max. piping length		m	70	70	100	
	Max level difference		m	30	30	50	

\* 1) Indoor temperature : 27°C DB, 19°C WB / Outdoor temperature : 35°C DB, 24°C WB / Piping length : 10m, difference : 0m

\* 2) Indoor temperature : 20°C DB / Outdoor temperature : 7°C DB, 6°C WB / Piping length : 10m, difference : 0m

\* 3) Actual noise level may differ, depending on the room structure, etc, since these noise values are from an anechoic room.

Model				RVMH060GBM0	RVMH060GDM0	RVMH080GAM0	RVMH100GAM0	RVMH100GCM0	
Power supply		ø, V, Hz		3, 380-415, 50	3, 380-415, 50	3, 380-415, 50	3, 380-415, 50	3, 380-415, 50	
Remark				Heat pump					
				Set	Set	Set	Set	Set	
Performance	Capacity	Cooling * 1)	Btu/h	55000(7000-55000)	55000(7000-55000)	76000(7000-76000)	95500(7000-95500)	95500(7000-95500)	
			kW	16.0(2.0-16.0)	16.0(2.0-16.0)	22.4(2-22.4)	28.0(2.0-28.0)	28.0(2.0-28.0)	
		Heating * 2)	Btu/h	61000(7500-61000)	61000(7500-61000)	85000(7500-85000)	107500(7500-107500)	107500(7500-107500)	
			kW	18.0(2.2-18)	18.0(2.2-18)	25.0(2.2-25)	31.5(2.2-31.5)	31.5(2.2-31.5)	
	Sound Level (Front View) * 3)	Cooling	dB	57	57	59	59	59	
		Heating	dB	57	57	59	59	59	
Power	Compressor	Model	-	ZRD72KC-TFD	ZRD72KCE-TFD	ZRDU13MC-TFD	ZRDT14MC-TFD	ZRDT14MCE-TFD	
		Type	-	Digital scroll	Digital scroll	Digital scroll + Fixed scroll	Digital scroll + Fixed scroll	Digital scroll + Fixed scroll	
		Piston displacement	cc/Rev	98.04	98.04	98.04+82.59	98.04+98.04	98.04+98.04	
		Output	kW	4.2	4.2	4.2+3.5	4.2+4.2	4.2+4.2	
	Fan output	Type	-	Propeller	Propeller	Propeller	Propeller	Propeller	
		Output	Watt	128 x 2	128 x 2	450	450	450	
		Air flow rate	m <sup>3</sup> /min	95	95	150	150	150	
	Running current	Cooling	A	8.0(5.0-8.0)	10.5	17.0	20 (5.8-20)	22.0	
		Heating	A	8.6(6.0-8.6)	10.5	16.0	19 (6.5-19)	21.0	
	Power input	Cooling	Watt	5600(1800-5600)	6200	9500	11000 (2300-11000)	12000	
		Heating	Watt	5900(2800-5900)	6200	9500	11000 (2300-10500)	12000	
	Others	Design pressure		Mpa	2.9	2.9	2.9	2.9	2.9
		Refrigerant	Name	-	R-22	R407C	R-22	R-22	R407C
			Charge	kg	8.0	8.0	13	14	14
Control			-	EEV	EEV	EEV	EEV	EEV	
Refrigerant oil		Name	-	Sontex 200LT	POE	Sontex 200LT	Sontex 200LT	POE	
		Charge	cc	1890	1890	1890 x 2	1890 x 2	1890 x 2	
Connecting pipe		Liquid	mm	9.52	9.52	12.70	12.70	12.70	
		Gas	mm	22.20	22.20	25.40	28.10	28.10	
		Drain	mm	-	-	-	-	-	
Size		Net weight		kg	150	150	310	310	310
	Shipping weight		kg	166	166	320	320	320	
	Net dimension (WxHxD)		mm	930x1270x385	930x1270x385	990x1765x780	990x1765x780	990x1765x780	
	Shipping dimension(Carton/Case) (WxHxD)		mm	1124x1404x509	1124x1404x509	1084x2090x984	1084x2090x984	1084x2090x984	
Function / Option	Temperature range (Outdoor)	Cooling	°C	-5 to 43	-5 to 43	-5 to 43	-5 to 54	-5 to 43	
		Heating	°C	-15 to 21	-15 to 21	-15 to 21	-15 to 21	-15 to 21	
	Max. piping length		m	70	70	100	100	100	
	Max level difference		m	30	30	50	50	50	

- \* 1) Indoor temperature : 27°C DB, 19°C WB / Outdoor temperature : 35°C DB, 24°C WB / Piping length : 10m, difference : 0m  
\* 2) Indoor temperature : 20°C DB / Outdoor temperature : 7°C DB, 6°C WB / Piping length : 10m, difference : 0m  
\* 3) Actual noise level may differ, depending on the room structure, etc, since these noise values are from an anechoic room.



## 2. Specification

### 2-2. 60Hz

Model			RVMC050CBM0	RVMC080FAM0	RVMC100FAM0	RVMH050CBM0	RVMH100FAM0		
Power supply			ø, V, Hz		1, 208-230, 60	3, 208-230, 60	3, 208-230, 60		
Remark			Cooling only			Heat pump			
			Set	Set	Set	Set	Set		
Performance	Capacity (ISO)	Cooling * 1)	Btu/h	50000(7000-50000)	76000(7000-76000)	95500(7000-95500)	50000(7000-50000)	95500(7000-95500)	
			kW	14.5(2.0-14.5)	22.4(2.0-22.4)	28.0(2.0-28.0)	14.5(2.0-14.5)	28.0(2.0-28.0)	
		Heating * 2)	Btu/h	-	-	-	55000(7500-55000)	107500(7500-107500)	
			kW	-	-	-	16.0(2.2-16.0)	31.5(2.2-31.5)	
	Capacity (SASO)	Cooling * 3)	Btu/h	-	60500	81000	-	81000	
			kW	-	17.7	23.7	-	23.7	
	Sound Level (Front View) * 4)	Cooling	dB	57	59	59	57	59	
		Heating	dB	-	-	-	57	59	
Power	Compressor	Model	-	ZRD49KC-PFV	ZRD72KC-TF5	ZRDU13MC-TF5	ZRD49KC-PFV	ZRDU13MC-TF5	
		Type	-	Digital scroll	Digital scroll	Digital scroll +Fixed scroll	Digital scroll	Digital scroll +Fixed scroll	
		Piston displacement	cc/Rev	67.12	98.04	98.04+82.59	67.12	98.04+82.59	
		Output	kW	3.7	5.5	5.5+4.3	3.7	5.5+4.3	
	Fan output	Type	-	Propeller	Propeller	Propeller	Propeller	Propeller	
		Output	Watt	138 x 2	450	450	138 x 2	450	
		Air flow rate	m <sup>3</sup> /min	95	150	150	95	150	
	Running current (ISO)	Cooling	A	22.2	17.0	31.0 (6.4-31.0)	22.2	31.0(6.4-31.0)	
		Heating	A	-	-	-	25.0	29.0(7.9-29.0)	
	Power input (ISO)	Cooling	Watt	4400	7850	11000 (2300-11000)	4400	11000(2300-11000)	
		Heating	Watt	-	-	-	4950	10500(2800-10500)	
	Running current (SASO)	Cooling	A	-	-	35.4	-	35.4	
		Heating	A	-	-	-	-	29.0	
	Power input (SASO)	Cooling	Watt	-	-	12540	-	12540	
		Heating	Watt	-	-	-	-	10500	
	Others	Design pressure	Mpa	2.9	2.9	2.9	2.9	2.9	
		Refrigerant	Name	-	R-22	R-22	R-22	R-22	R-22
			Charge	kg	9	13	14	10	14
Control			-	EEV	EEV	EEV	EEV	EEV	
Refrigerant oil		Name	-	Sontex 200LT	Sontex 200LT	Sontex 200LT	Sontex 200LT	Sontex 200LT	
		Charge	cc	1890	1890	1890 x 2	1890	1890 x 2	
Connecting pipe		Liquid	mm	9.52	12.70	12.70	9.52	12.70	
		Gas	mm	19.05	25.40	28.60	19.05	28.60	
		Drain	mm	-	-	-	-	-	
Size		Net weight	kg	142	270	300	150	310	
	Shipping weight	kg	158	280	310	166	320		
	Net dimension (WxHxD)	mm	930x1270x385	990X1765X780	990X1765X780	930x1270x385	990X1765X780		
	Shipping dimension(Carton/Case) (WxHxD)	mm	1124x1404x509	1084X2090X984	1084X2090X984	1124x1404x509	1084X2090X984		
Function / Option	Temperature range (Outdoor)	Cooling	°C	-5 to 43	-5 to 43	-5 to 54	-5 to 43	-5 to 54	
		Heating	°C	-	-	-	-15 to 21	-15 to 21	
	Max. piping length	m	100	100	100	70	100		
	Max level difference	m	30	50	50	30	50		

\* 1) Indoor temperature : 27°C DB, 19°C WB / Outdoor temperature : 35°C DB, 24°C WB / Piping length : 10m, difference : 0m

\* 2) Indoor temperature : 20°C DB / Outdoor temperature : 7°C DB, 6°C WB / Piping length : 10m, difference : 0m

\* 3) Indoor temperature : 29°C DB, 19°C WB / Outdoor temperature : 46°C DB, 24°C WB / Piping length : 10m, difference : 0m

\* 4) Actual noise level may differ, depending on the room structure, etc, since these noise values are from an anechoic room.

Model				RVMC075FAM0	MUF7201F1	
Power supply			ø, V, Hz	3, 208-230, 60	3, 380, 60	1, 220, 60
Remark				Cooling only		
				Set	Set	Super Cooler
Performance	Capacity (ISO)	Cooling * 1)	Btu/h	71000	71000	-
			kW	20.8	20.8	-
		Heating * 2)	Btu/h	-	-	-
			kW	-	-	-
	Capacity (SASO)	Cooling * 3)	Btu/h	?	60500	-
			kW	?	17.7	-
Sound Level (Front View) * 4)	Cooling	dB	54	54	-	
	Heating	dB	-	-	-	
Power	Compressor	Model	-	ZRD72KC-TF5	ZRD72KC-TF7	-
		Type	-	Digital scroll	Digital scroll	-
		Piston displacement	cc/Rev	98.04	98.04	-
		Output	kW	5.5	5.5	-
	Fan output	Type	-	Propeller	Propeller	Propeller
		Output	Watt	106 x 2	106 x 2	106
		Air flow rate	m <sup>3</sup> /min	90	90	45
	Running current (ISO)	Cooling	A	24	11.5	1.5
		Heating	A	-	-	-
	Power input (ISO)	Cooling	Watt	7100	7100	160
		Heating	Watt	-	-	-
	Running current (SASO)	Cooling	A	27.4	13.2	-
		Heating	A	-	-	-
	Power input (SASO)	Cooling	Watt	8100	8100	-
Heating		Watt	-	-	-	
Others	Design pressure		Mpa	2.9	2.9	2.9
	Refrigerant	Name	-	R-22	R-22	-
		Charge	kg	9.0	9.0	-
		Control	-	EEV	EEV	-
	Refrigerant oil	Name	-	Sontex 200LT	Sontex 200LT	-
		Charge	cc	1890	1890	-
	Connecting pipe	Liquid	mm	12.70	12.70	12.70
		Gas	mm	25.40	25.40	25.40
		Drain	mm	-	-	-
Size	Net weight		kg	178	178	40
	Shipping weight		kg	186	186	45
	Net dimension (WxHxD)		mm	1170x1090x600	1170x1090x600	600x1090x600
	Shipping dimension (Carton/Case) (WxHxD)		mm	1237x1225x685	1237x1225x685	770x1225x685
Function / Option	Temperature range (Outdoor)	Cooling	°C	-5 to 54	-5 to 54	-
		Heating	°C	-	-	-
	Max. piping length		m	100	100	-
	Max level difference		m	30	30	-

\* 1) Indoor temperature : 27°C DB, 19°C WB / Outdoor temperature : 35°C DB, 24°C WB / Piping length : 10m, difference : 0m

\* 2) Indoor temperature : 20°C DB / Outdoor temperature : 7°C DB, 6°C WB / Piping length : 10m, difference : 0m

\* 3) Indoor temperature : 29°C DB, 19°C WB / Outdoor temperature : 46°C DB, 24°C WB / Piping length : 10m, difference : 0m

\* 4) Actual noise level may differ, depending on the room structure, etc, since these noise values are from an anechoic room.



## 3. Functional parts and safety devices

### 3-1. Outdoor unit

Item	Code	Name	RVMC050CBM0	RVMC060GAM0 RVMC060GAM1	RVMC060GDM0	
Compressor	-	Motor output	ZRD49KC-PFV 3.7kW	ZRD72KC-TFD 4.5kW	ZRD72KCE-TFD 4.5kW	
	-	Compressor safety OLP	open temp.	120°C	145°C	145°C
			trip current	37A	48A	48A
	CCH	Crank case heater	90W	90W	90W	
Safety devices	Motor	Fan motor	model	-	OSME1284SRC	OSME1284SRC
			output	138W + 138W	128W + 128W	128W + 128W
		Safety thermostat	on	135°C	150°C	150°C
			off	90°C	100°C	100°C
	HPS	High pressure switch	OFF : 30(±1)kg/cm <sup>2</sup> ON : 22(±1)kg/cm <sup>2</sup>			
LPS	Low pressure switch	OFF : 1.2(±0.2)kg/cm <sup>2</sup> ON : 2.2(±0.2)kg/cm <sup>2</sup>				
Temperature sensor	DTS	Thermistor (discharge)	Model : 0166-01, Rt=150°C, 25°C=86Ω			
	CMS	Thermistor (condenser center)	103AT (25°C=10kΩ)			
	COS	Thermistor (condenser outlet)	103AT (25°C=10kΩ)			
	OATS	Thermistor (outdoor temperature)	103AT (25°C=10kΩ)			
	SUC.S	Suction sensor	-	-	-	
	OIL.S	Oil sensor	-	-	-	
Functional parts	PWM	Solenoid valve (for compressor operation)	Coil : Copeland (Part # 023-0028-03) Body : EPV-1530D			
	HGBV	Solenoid valve (for bypass of high temperature gas)	Coil : Signomiya Body : NEV-603D			
	LBV	Solenoid valve (liquid injection)	Coil : Signomiya			
	VBV	Solenoid valve (for exhaust air)	Body : NEV-202D			
	BV1	Solenoid valve (for capacity control)	-	-	-	
	BV2	Solenoid valve (for capacity control)	-	-	-	
	4-W/V	4-way valve	-	-	-	
	C/V	Check valve	-	-	-	



Item	Code	Name	MUF7201F1	RVMC075FAM0	RVMC080FAM0	RVMC100GAM0	RVMC100FAM0	
Compressor	-	Motor output	ZRD72KC-TF7 5.5kW	ZRD72KC-TF5 5.5kW	ZRD72KC-TF5 5.5kW	ZRDT14MC-TFD 4.2kW + 4.2kW	ZRDU13MC-TF5 5.5kW + 4.3kW	
	-	Compressor safety OLP	open temp.	155°C				
			trip current	70A				
	CCH	Crank case heater	90W	90W	90W	90W	90W	
Safety devices	Motor	Fan motor	model	OSM1076SRC	OSM1076SRC	OSM4508SRC	OSM4506SRC	OSM4508SRC
			output	106W + 106W	106W + 106W	580W	450W	450W
		Safety thermostat	on	150°C	150°C	150°C	150°C	150°C
			off	100°C	100°C	100°C	100°C	100°C
	HPS	High pressure switch	OFF : 30(±1)kg/cm <sup>2</sup> ON : 22(±1)kg/cm <sup>2</sup>					
LPS	Low pressure switch	OFF : 1.2(±0.2)kg/cm <sup>2</sup> ON : 2.2(±0.2)kg/cm <sup>2</sup>						
Temperature sensor	DTS	Thermistor (discharge)	Model : 0166-01, Rt=150°C, 25°C=86Ω					
	CMS	Thermistor (condenser center)	103AT (25°C=10kΩ)					
	COS	Thermistor (condenser outlet)	103AT (25°C=10kΩ)					
	OATS	Thermistor (outdoor temperature)	103AT (25°C=10kΩ)					
	SUC.S	Suction sensor	-	-	-	-	-	
	OIL.S	Oil sensor	-	-	-	-	-	
Functional parts	PWM	Solenoid valve (for compressor operation)	Coil : Copeland (Part # 023-0028-03) Body : EPV-1530D					
	HGBV	Solenoid valve (for bypass of high temperature gas)	Coil : Siginomiya Body : NEV-603D					
	LBV	Solenoid valve (liquid injection)	Coil : Siginomiya					
	VBV	Solenoid valve (for exhaust air)	Body : NEV-202D					
	BV1	Solenoid valve (for capacity control)	-	-	-	-	-	
	BV2	Solenoid valve (for capacity control)	-	-	-	-	-	
	4-W/V	4-way valve	-	-	-	-	-	
	C/V	Check valve	-	-	-	-	-	



### 3. Functional parts and safety devices

Item	Code	Name	RVMH050CBM0	RVMH060GBM0	RVMH060GDM0	RVMH080GAM0	
Compressor	-	Motor output	ZRD49KC-PFV 3.7kW	ZRD72KC-TFD 4.5kW	ZRD72KCE-TFD 4.5kW	ZRDU13MC-TFD 4.2kW + 3.5kW	
	-	Compressor safety OLP	open temp.	120°C	145°C	145°C	155°C
			trip current	37A	48A	48A	70A
	CCH	Crank case heater	90W	90W	90W	90W	
Safety devices	Motor	Fan motor	model	-	OSME1596SRC	OSME1596SRC	OSME4506SRC
			output	138W + 138W	128W + 128W	128W + 128W	450W
	Safety thermostat	on	135°C	150°C	150°C	150°C	
		off	90°C	100°C	100°C	100°C	
	HPS	High pressure switch	OFF : 30(±1)kg/cm <sup>2</sup> ON : 22(±1)kg/cm <sup>2</sup>				
LPS	Low pressure switch	OFF : 1.2(±0.2)kg/cm <sup>2</sup> ON : 2.2(±0.2)kg/cm <sup>2</sup>					
Temperature sensor	DTS	Thermistor (discharge)	Model : 0166-01, Rt=150°C, 25°C=86Ω				
	CMS	Thermistor (condenser center)	103AT (25°C=10kΩ)				
	COS	Thermistor (condenser outlet)	103AT (25°C=10kΩ)				
	OATS	Thermistor (outdoor temperature)	103AT (25°C=10kΩ)				
	SUC.S	Suction sensor	103AT (25°C=10kΩ)				
	OIL.S	Oil sensor	103AT (25°C=10kΩ)				
	FDTS	Thermistor (fixed discharge)	204CTB (25°C=200kΩ)				
Functional parts	PWM	Solenoid valve (for compressor operation)	Coil : Copeland (Part # 023-0028-03) Body : EPV-1530D				
	HGBV	Solenoid valve (for bypass of high temperature gas)	Coil : Signomiya Body : NEV-603D				
	LBV	Solenoid valve (liquid injection)	Coil : Signomiya Body : NEV-202D				
	VBV	Solenoid valve (for exhaust air)					
	BV1	Solenoid valve (for capacity control)	-	-	-	-	
	BV2	Solenoid valve (for capacity control)	-	-	-	-	
	4-W/V	4-way valve	Coil & Body : JAPAN RANCO VH-60100			Coil & Body : JAPAN RANCO VH-61100	
	C/V	Check valve	Fujikoki (30kg/cm <sup>2</sup> )				

Item	Code	Name	RVMH100GAM0	RVMH100FAM0	
Compressor	-	Motor output	ZRDT14MC-TFD 4.2kW + 4.2kW	ZRDU13MC-TF5 5.5kW + 4.3kW	
	-	Compressor safety OLP	open temp.	155°C	155°C
			trip current	70A	70A
	CCH	Crank case heater	90W	90W	
Safety devices	Motor	Fan motor	model	OSME4506SRC	OSME4508SRC
			output	450W	450W
	Safety thermostat	on	150°C	150°C	
		off	100°C	100°C	
	HPS	High pressure switch	OFF : 30(±1)kg/cm <sup>2</sup> ON : 22(±1)kg/cm <sup>2</sup>		
LPS	Low pressure switch	OFF : 1.2(±0.2)kg/cm <sup>2</sup> ON : 2.2(±0.2)kg/cm <sup>2</sup>			
Temperature sensor	DTS	Thermistor (discharge)	Model : 0166-01, Rt=150°C, 25°C=86Ω		
	CMS	Thermistor (condenser center)	103AT (25°C=10kΩ)		
	COS	Thermistor (condenser outlet)	103AT (25°C=10kΩ)		
	OATS	Thermistor (outdoor temperature)	103AT (25°C=10kΩ)		
	SUC.S	Suction sensor	103AT (25°C=10kΩ)		
	OIL.S	Oil sensor	103AT (25°C=10kΩ)		
	FDTS	Thermistor (fixed discharge)	204CTB (25°C=200kΩ)		
Functional parts	PWM	Solenoid valve (for compressor operation)	Coil : Copeland (Part # 023-0028-03) Body : EPV-1530D		
	HGBV	Solenoid valve (for bypass of high temperature gas)	Coil : Siginomiya Body : NEV-603D		
	LBV	Solenoid valve (liquid injection)	Coil : Siginomiya		
	VBV	Solenoid valve (for exhaust air)	Body : NEV-202D		
	BV1	Solenoid valve (for capacity control)	-		
	BV2	Solenoid valve (for capacity control)	-		
	4-W/V	4-way valve	Coil & Body : JAPAN RANCO VH-61100		
	C/V	Check valve	Fujikoki (30kg/cm <sup>2</sup> )		



### 3. Functional parts and safety devices

Item	Code	Name	RVMH100GCM0	
Compressor	-	Motor output	ZRDT14MCE-TFD 4.2kW + 4.2kW	
	-	Compressor safety OLP	open temp.	155°C
			trip current	70A
	CCH	Crank case heater	90W	
Safety devices	Motor	Fan motor	model	OSME4506SRC
			output	450W
	Safety thermostat	on	150°C	
		off	100°C	
	HPS	High pressure switch	OFF : 30(±1)kg/cm <sup>2</sup> ON : 22(±1)kg/cm <sup>2</sup>	
LPS	Low pressure switch	OFF : 1.2(±0.2)kg/cm <sup>2</sup> ON : 2.2(±0.2)kg/cm <sup>2</sup>		
Temperature sensor	DTS	Thermistor (discharge)	Model : 0166-01, Rt=150°C, 25°C=86Ω	
	CMS	Thermistor (condenser center)	103AT (25°C=10kΩ)	
	COS	Thermistor (condenser outlet)	103AT (25°C=10kΩ)	
	OATS	Thermistor (outdoor temperature)	103AT (25°C=10kΩ)	
	SUC.S	Suction sensor	103AT (25°C=10kΩ)	
	OIL.S	Oil sensor	103AT (25°C=10kΩ)	
	FDTS	Thermistor (fixed discharge)	204CTB (25°C=200kΩ)	
Functional parts	PWM	Solenoid valve (for compressor operation)	Coil : Copeland (Part # 023-0028-03) Body : EPV-1530D	
	HGBV	Solenoid valve (for bypass of high temperature gas)	Coil : Signomiya Body : NEV-603D	
	LBV	Solenoid valve (liquid injection)	Coil : Signomiya	
	VBV	Solenoid valve (for exhaust air)	Body : NEV-202D	
	BV1	Solenoid valve (for capacity control)	-	
	BV2	Solenoid valve (for capacity control)	-	
	4-W/V	4-way valve	Coil & Body : JAPAN RANCO VH-61100	
	C/V	Check valve	Fujikoki (30kg/cm <sup>2</sup> )	

### 3-2. Super cooler

Item	Code	Name	MUF7201F1 (SUB)
Compressor	-	Motor output	-
	-	Compressor safety OLP	open temp.
			trip current
	CCH	Crank case heater	-
Safety devices	Motor	Fan motor	model
			output
	Safety thermostat	on	
		off	
	HPS	High pressure switch	-
LPS	Low pressure switch	-	
Temperature sensor	DTS	Thermistor (discharge)	-
	CMS	Thermistor (condenser center)	-
	COS	Thermistor (condenser outlet)	-
	OATS	Thermistor (outdoor temperature)	-
	SUC.S	Suction senser	-
	OIL.S	Oil senser	-
	FDTS	Thermistor (fixed discharge)	-
Functional parts	PWM	Solenoid valve (for compressor operation)	-
	HGBV	Solenoid valve (for bypass of high temperature gas)	-
	LBV	Solenoid valve (liquid injection)	-
	VBV	Solenoid valve (for exhaust air)	-
	BV1	Solenoid valve (for capacity control)	-
	BV2	Solenoid valve (for capacity control)	-
	4-W/V	4-way valve	-
	C/V	Check valve	-



# 4. Capacity table

## 4-1. 50Hz

### (1) Cooling

1) \*\*060\*\*

TC : Total capacity, PI : Power input

Combination, %(Capacity index)	Outdoor temperature (°C, DB)	Indoor temperature (°C, WB)													
		14		16		18		19		20		22		24	
		TC	PI	TC	PI	TC	PI	TC	PI	TC	PI	TC	PI	TC	PI
		kW	kW	kW	kW	kW	kW	kW	kW	kW	kW	kW	kW	kW	kW
100	10	11.7	2.3	13.8	2.9	16.4	3.5	17.3	3.8	18.4	4.1	20.5	4.7	22.7	5.3
	12	11.7	2.4	13.8	2.9	16.4	3.5	17.3	3.8	18.4	4.1	20.5	4.8	22.7	5.4
	14	11.7	2.4	13.8	3.0	16.4	3.6	17.3	3.9	18.4	4.2	20.5	4.9	22.7	5.5
	16	11.7	2.4	13.8	3.0	16.4	3.6	17.3	4.0	18.4	4.3	20.5	4.9	22.7	5.6
	18	11.7	2.5	13.8	3.1	16.4	3.7	17.3	4.0	18.4	4.4	20.5	5.0	22.7	5.7
	20	11.7	2.5	13.8	3.2	16.4	3.8	17.3	4.2	18.4	4.5	20.5	5.2	22.7	5.8
	21	11.7	2.6	13.8	3.2	16.4	3.9	17.3	4.2	18.4	4.6	20.5	5.3	22.7	6.0
	23	11.7	2.7	13.8	3.3	16.4	4.0	17.3	4.4	18.4	4.7	20.5	5.4	22.6	6.0
	25	11.7	2.8	13.8	3.5	16.4	4.2	17.1	4.6	18.2	5.0	20.3	5.7	22.0	6.1
	27	11.7	2.9	13.8	3.7	16.4	4.4	16.9	4.8	17.9	5.2	20.0	5.9	21.3	6.1
	29	11.7	3.1	13.8	3.8	16.4	4.6	16.7	5.0	17.7	5.4	19.6	6.0	20.7	6.2
	31	11.7	3.2	13.8	4.0	16.1	4.8	16.4	5.2	17.5	5.6	19.0	6.0	20.1	6.1
	33	11.7	3.3	13.8	4.1	15.8	5.0	16.2	5.4	17.2	5.8	18.4	6.0	19.5	6.1
	35	11.7	3.4	13.8	4.3	15.7	5.2	16.0	5.6	16.8	5.8	17.8	6.0	18.9	6.1
	37	11.7	3.7	13.8	4.6	15.5	5.5	15.7	5.9	16.2	6.3	17.2	6.1	18.2	6.3
	39	11.7	4.0	13.6	5.0	15.3	5.9	15.4	6.1	15.6	6.2	16.6	6.3	17.5	6.5
42	11.7	4.4	13.2	5.5	14.7	6.2	15.1	6.3	14.9	6.4	15.8	6.6	16.7	6.8	
44	11.6	4.7	13.1	5.8	14.4	6.3	14.9	6.4	14.3	6.5	15.2	6.7	16.2	6.9	
46	11.5	5.1	12.9	6.2	14.1	6.5	14.6	6.6	13.8	6.7	14.7	6.9	15.5	7.1	
90	10	10.54	2.11	12.44	2.59	14.79	3.11	15.58	3.38	16.55	3.66	18.46	4.22	20.41	4.78
	12	10.54	2.14	12.44	2.63	14.79	3.16	15.58	3.44	16.55	3.72	18.46	4.29	20.41	4.86
	14	10.54	2.17	12.44	2.67	14.79	3.22	15.58	3.50	16.55	3.79	18.46	4.38	20.41	4.97
	16	10.54	2.20	12.44	2.72	14.79	3.28	15.58	3.56	16.55	3.85	18.46	4.45	20.41	5.01
	18	10.54	2.24	12.44	2.77	14.79	3.34	15.58	3.63	16.55	3.95	18.46	4.52	20.41	5.13
	20	10.54	2.29	12.44	2.85	14.79	3.44	15.58	3.75	16.55	4.03	18.46	4.65	20.41	5.24
	21	10.54	2.34	12.44	2.90	14.79	3.50	15.58	3.81	16.55	4.12	18.46	4.74	20.41	5.36
	23	10.54	2.41	12.44	3.00	14.79	3.63	15.58	3.93	16.55	4.27	18.46	4.90	20.34	5.40
	25	10.54	2.53	12.44	3.15	14.79	3.79	15.38	4.12	16.34	4.48	18.23	5.11	19.78	5.47
	27	10.54	2.64	12.44	3.30	14.79	3.98	15.19	4.30	16.13	4.66	18.00	5.34	19.19	5.50
	29	10.54	2.77	12.44	3.44	14.79	4.14	14.99	4.49	15.93	4.87	17.60	5.38	18.64	5.54
	31	10.54	2.88	12.44	3.58	14.53	4.30	14.79	4.67	15.72	5.04	17.07	5.36	18.06	5.51
	33	10.54	3.00	12.44	3.73	14.20	4.49	14.60	4.86	15.51	5.25	16.55	5.37	17.53	5.53
	35	10.54	3.10	12.44	3.88	14.14	4.65	14.40	5.04	15.08	5.22	16.04	5.37	16.97	5.52
	37	10.54	3.33	12.44	4.14	13.94	4.96	14.14	5.29	14.55	5.65	15.46	5.50	16.38	5.65
	39	10.54	3.61	12.24	4.49	13.75	5.35	13.88	5.47	14.00	5.56	14.90	5.71	15.77	5.87
42	10.54	3.96	11.91	4.92	13.25	5.56	13.61	5.65	13.37	5.75	14.19	5.90	15.04	6.08	
44	10.41	4.25	11.78	5.23	12.96	5.69	13.42	5.78	12.91	5.85	13.72	6.03	14.56	6.18	
46	10.34	4.56	11.65	5.62	12.67	5.87	13.16	5.96	12.42	6.06	13.19	6.21	13.98	6.40	
80	10	9.37	1.87	11.05	2.30	13.15	2.77	13.85	3.00	14.71	3.25	16.41	3.75	18.14	4.25
	12	9.37	1.90	11.05	2.34	13.15	2.81	13.85	3.06	14.71	3.31	16.41	3.81	18.14	4.32
	14	9.37	1.93	11.05	2.38	13.15	2.86	13.85	3.11	14.71	3.37	16.41	3.89	18.14	4.41
	16	9.37	1.96	11.05	2.41	13.15	2.91	13.85	3.17	14.71	3.42	16.41	3.96	18.14	4.46
	18	9.37	1.99	11.05	2.46	13.15	2.97	13.85	3.22	14.71	3.51	16.41	4.02	18.14	4.56
	20	9.37	2.04	11.05	2.53	13.15	3.05	13.85	3.33	14.71	3.58	16.41	4.13	18.14	4.66
	21	9.37	2.08	11.05	2.58	13.15	3.11	13.85	3.39	14.71	3.66	16.41	4.21	18.14	4.76
	23	9.37	2.15	11.05	2.66	13.15	3.23	13.85	3.50	14.71	3.79	16.41	4.36	18.08	4.80
	25	9.37	2.25	11.05	2.80	13.15	3.37	13.67	3.66	14.53	3.98	16.21	4.54	17.58	4.86
	27	9.37	2.35	11.05	2.93	13.15	3.54	13.50	3.82	14.34	4.14	16.00	4.74	17.05	4.89
	29	9.37	2.46	11.05	3.05	13.15	3.68	13.32	3.99	14.16	4.33	15.64	4.78	16.57	4.92
	31	9.37	2.56	11.05	3.18	12.92	3.82	13.15	4.15	13.97	4.48	15.17	4.76	16.05	4.90
	33	9.37	2.67	11.05	3.31	12.63	3.99	12.97	4.32	13.79	4.67	14.71	4.78	15.58	4.91
	35	9.37	2.76	11.05	3.45	12.57	4.14	12.80	4.48	13.40	4.64	14.26	4.77	15.09	4.90
	37	9.37	2.96	11.05	3.68	12.39	4.40	12.57	4.70	12.93	5.02	13.75	4.89	14.56	5.02
	39	9.37	3.21	10.88	3.99	12.22	4.75	12.33	4.86	12.44	4.94	13.24	5.08	14.01	5.22
42	9.37	3.52	10.59	4.37	11.78	4.94	12.10	5.03	11.89	5.11	12.62	5.24	13.37	5.41	
44	9.25	3.77	10.47	4.65	11.52	5.06	11.93	5.14	11.47	5.20	12.19	5.36	12.94	5.50	
46	9.19	4.05	10.36	4.99	11.26	5.22	11.69	5.30	11.04	5.38	11.72	5.52	12.43	5.69	

TC : Total capacity, PI : Power input

Combination, %(Capacity index)	Outdoor temperature (°C, DB)	Indoor temperature (°C, WB)													
		14		16		18		19		20		22		24	
		TC	PI	TC	PI	TC	PI	TC	PI	TC	PI	TC	PI	TC	PI
		kW	kW	kW	kW	kW	kW	kW	kW	kW	kW	kW	kW	kW	kW
70	10	8.20	1.64	9.67	2.02	11.51	2.42	12.12	2.63	12.87	2.85	14.36	3.28	15.88	3.72
	12	8.20	1.66	9.67	2.05	11.51	2.46	12.12	2.68	12.87	2.90	14.36	3.33	15.88	3.78
	14	8.20	1.68	9.67	2.08	11.51	2.50	12.12	2.72	12.87	2.95	14.36	3.41	15.88	3.86
	16	8.20	1.71	9.67	2.11	11.51	2.55	12.12	2.77	12.87	3.00	14.36	3.46	15.88	3.90
	18	8.20	1.74	9.67	2.16	11.51	2.60	12.12	2.82	12.87	3.07	14.36	3.52	15.88	3.99
	20	8.20	1.78	9.67	2.21	11.51	2.67	12.12	2.92	12.87	3.13	14.36	3.62	15.88	4.08
	21	8.20	1.82	9.67	2.26	11.51	2.72	12.12	2.96	12.87	3.20	14.36	3.68	15.88	4.17
	23	8.20	1.88	9.67	2.33	11.51	2.83	12.12	3.06	12.87	3.32	14.36	3.81	15.82	4.20
	25	8.20	1.97	9.67	2.45	11.51	2.95	11.96	3.20	12.71	3.48	14.18	3.97	15.38	4.25
	27	8.20	2.06	9.67	2.57	11.51	3.09	11.81	3.35	12.55	3.62	14.00	4.15	14.92	4.28
	29	8.20	2.15	9.67	2.67	11.51	3.22	11.66	3.49	12.39	3.79	13.69	4.18	14.49	4.31
	31	8.20	2.24	9.67	2.79	11.30	3.34	11.51	3.63	12.22	3.92	13.28	4.17	14.05	4.29
	33	8.20	2.33	9.67	2.90	11.05	3.49	11.35	3.78	12.06	4.09	12.87	4.18	13.63	4.30
	35	8.20	2.41	9.67	3.02	11.00	3.62	11.20	3.92	11.73	4.06	12.48	4.18	13.20	4.29
	37	8.20	2.59	9.67	3.22	10.84	3.85	11.00	4.11	11.32	4.39	12.03	4.27	12.74	4.39
	39	8.20	2.80	9.52	3.49	10.69	4.16	10.79	4.25	10.89	4.33	11.59	4.44	12.26	4.56
	42	8.20	3.08	9.27	3.82	10.30	4.33	10.59	4.40	10.40	4.47	11.04	4.59	11.70	4.73
44	8.09	3.30	9.16	4.07	10.08	4.43	10.44	4.50	10.04	4.55	10.67	4.69	11.32	4.81	
46	8.04	3.54	9.06	4.37	9.86	4.56	10.23	4.64	9.66	4.71	10.26	4.83	10.87	4.98	
60	10	7.03	1.41	8.29	1.73	9.86	2.07	10.39	2.25	11.03	2.44	12.31	2.81	13.61	3.19
	12	7.03	1.42	8.29	1.75	9.86	2.11	10.39	2.29	11.03	2.48	12.31	2.86	13.61	3.24
	14	7.03	1.44	8.29	1.78	9.86	2.15	10.39	2.34	11.03	2.53	12.31	2.92	13.61	3.31
	16	7.03	1.47	8.29	1.81	9.86	2.18	10.39	2.38	11.03	2.57	12.31	2.97	13.61	3.34
	18	7.03	1.49	8.29	1.85	9.86	2.23	10.39	2.42	11.03	2.63	12.31	3.02	13.61	3.42
	20	7.03	1.53	8.29	1.90	9.86	2.29	10.39	2.50	11.03	2.68	12.31	3.10	13.61	3.49
	21	7.03	1.56	8.29	1.94	9.86	2.33	10.39	2.54	11.03	2.75	12.31	3.16	13.61	3.57
	23	7.03	1.61	8.29	2.00	9.86	2.42	10.39	2.62	11.03	2.84	12.31	3.27	13.56	3.60
	25	7.03	1.69	8.29	2.10	9.86	2.53	10.25	2.75	10.90	2.99	12.15	3.40	13.18	3.65
	27	7.03	1.76	8.29	2.20	9.86	2.65	10.12	2.87	10.76	3.11	12.00	3.56	12.79	3.67
	29	7.03	1.84	8.29	2.29	9.86	2.76	9.99	2.99	10.62	3.25	11.73	3.59	12.42	3.69
	31	7.03	1.92	8.29	2.39	9.69	2.87	9.86	3.11	10.48	3.36	11.38	3.57	12.04	3.67
	33	7.03	2.00	8.29	2.48	9.47	2.99	9.73	3.24	10.34	3.50	11.03	3.58	11.69	3.68
	35	7.03	2.07	8.29	2.58	9.43	3.10	9.60	3.36	10.05	3.48	10.69	3.58	11.31	3.68
	37	7.03	2.22	8.29	2.76	9.29	3.30	9.43	3.52	9.70	3.76	10.31	3.66	10.92	3.76
	39	7.03	2.40	8.16	2.99	9.16	3.57	9.25	3.65	9.33	3.71	9.93	3.81	10.51	3.91
	42	7.03	2.64	7.94	3.28	8.83	3.71	9.08	3.77	8.91	3.83	9.46	3.93	10.03	4.06
44	6.94	2.83	7.85	3.49	8.64	3.79	8.95	3.86	8.61	3.90	9.15	4.02	9.70	4.12	
46	6.89	3.04	7.77	3.75	8.45	3.91	8.77	3.97	8.28	4.04	8.79	4.14	9.32	4.27	
50	10	5.85	1.17	6.91	1.44	8.22	1.73	8.65	1.88	9.20	2.03	10.26	2.35	11.34	2.66
	12	5.85	1.19	6.91	1.46	8.22	1.76	8.65	1.91	9.20	2.07	10.26	2.38	11.34	2.70
	14	5.85	1.20	6.91	1.49	8.22	1.79	8.65	1.95	9.20	2.11	10.26	2.43	11.34	2.76
	16	5.85	1.22	6.91	1.51	8.22	1.82	8.65	1.98	9.20	2.14	10.26	2.47	11.34	2.78
	18	5.85	1.24	6.91	1.54	8.22	1.86	8.65	2.01	9.20	2.19	10.26	2.51	11.34	2.85
	20	5.85	1.27	6.91	1.58	8.22	1.91	8.65	2.08	9.20	2.24	10.26	2.58	11.34	2.91
	21	5.85	1.30	6.91	1.61	8.22	1.95	8.65	2.12	9.20	2.29	10.26	2.63	11.34	2.98
	23	5.85	1.34	6.91	1.66	8.22	2.02	8.65	2.19	9.20	2.37	10.26	2.72	11.30	3.00
	25	5.85	1.41	6.91	1.75	8.22	2.10	8.55	2.29	9.08	2.49	10.13	2.84	10.99	3.04
	27	5.85	1.47	6.91	1.83	8.22	2.21	8.44	2.39	8.96	2.59	10.00	2.97	10.66	3.06
	29	5.85	1.54	6.91	1.91	8.22	2.30	8.33	2.49	8.85	2.70	9.78	2.99	10.35	3.08
	31	5.85	1.60	6.91	1.99	8.07	2.39	8.22	2.60	8.73	2.80	9.48	2.98	10.03	3.06
	33	5.85	1.67	6.91	2.07	7.89	2.49	8.11	2.70	8.62	2.92	9.20	2.99	9.74	3.07
	35	5.85	1.72	6.91	2.15	7.85	2.58	8.00	2.80	8.38	2.90	8.91	2.98	9.43	3.07
	37	5.85	1.85	6.91	2.30	7.75	2.75	7.85	2.94	8.08	3.14	8.59	3.05	9.10	3.14
	39	5.85	2.00	6.80	2.50	7.64	2.97	7.71	3.04	7.78	3.09	8.28	3.17	8.76	3.26
	42	5.85	2.20	6.62	2.73	7.36	3.09	7.56	3.14	7.43	3.19	7.88	3.28	8.36	3.38
44	5.78	2.36	6.55	2.91	7.20	3.16	7.45	3.21	7.17	3.25	7.62	3.35	8.09	3.44	
46	5.75	2.53	6.47	3.12	7.04	3.26	7.31	3.31	6.90	3.36	7.33	3.45	7.77	3.55	



## 4. Capacity table

2) \*\*100\*\*

TC : Total capacity, PI : Power input

Combination, %(Capacity index)	Outdoor temperature (°C, DB)	Indoor temperature (°C, WB)													
		14		16		18		19		20		22		24	
		TC	PI	TC	PI	TC	PI	TC	PI	TC	PI	TC	PI	TC	PI
		kW	kW	kW	kW	kW	kW	kW	kW	kW	kW	kW	kW	kW	kW
100	10	20.5	4.6	24.2	5.7	28.8	6.8	30.3	7.4	32.2	8.0	35.9	9.2	39.7	10.4
	12	20.5	4.7	24.2	5.7	28.8	6.9	30.3	7.5	32.2	8.1	35.9	9.4	39.7	10.6
	14	20.5	4.7	24.2	5.8	28.8	7.0	30.3	7.6	32.2	8.3	35.9	9.6	39.7	10.8
	16	20.5	4.8	24.2	5.9	28.8	7.2	30.3	7.8	32.2	8.4	35.9	9.7	39.7	10.9
	18	20.5	4.9	24.2	6.0	28.8	7.3	30.3	7.9	32.2	8.6	35.9	9.9	39.7	11.2
	20	20.5	5.0	24.2	6.2	28.8	7.5	30.3	8.2	32.2	8.8	35.9	10.2	39.7	11.4
	21	20.5	5.1	24.2	6.3	28.8	7.6	30.3	8.3	32.2	9.0	35.9	10.3	39.7	11.7
	23	20.5	5.3	24.2	6.5	28.8	7.9	30.3	8.6	32.2	9.3	35.9	10.7	39.6	11.8
	25	20.5	5.5	24.2	6.9	28.8	8.3	29.9	9.0	31.8	9.8	35.5	11.1	38.5	11.9
	27	20.5	5.8	24.2	7.2	28.8	8.7	29.5	9.4	31.4	10.2	35.0	11.6	37.3	12.0
	29	20.5	6.0	24.2	7.5	28.8	9.0	29.1	9.8	31.0	10.6	34.2	11.7	36.2	12.1
	31	20.5	6.3	24.2	7.8	28.3	9.4	28.8	10.2	30.6	11.0	33.2	11.7	35.1	12.0
	33	20.5	6.5	24.2	8.1	27.6	9.8	28.4	10.6	30.2	11.5	32.2	11.7	34.1	12.1
	35	20.5	6.8	24.2	8.5	27.5	10.2	28.0	11.0	29.3	11.4	31.2	11.7	33.0	12.0
	37	20.5	7.3	24.2	9.0	27.1	10.8	27.5	11.5	28.3	12.3	30.1	12.0	31.8	12.3
	39	20.5	7.9	23.8	9.8	26.7	11.7	27.0	11.9	27.2	12.1	29.0	12.5	30.7	12.8
42	20.5	8.7	23.2	10.7	25.8	12.1	26.5	12.3	26.0	12.5	27.6	12.9	29.3	13.3	
44	20.2	9.3	22.9	11.4	25.2	12.4	26.1	12.6	25.1	12.8	26.7	13.2	28.3	13.5	
46	20.1	9.9	22.7	12.3	24.6	12.8	25.6	13.0	24.2	13.2	25.6	13.6	27.2	14.0	
90	10	18.44	4.14	21.76	5.09	25.89	6.11	27.26	6.64	28.97	7.19	32.31	8.29	35.72	9.39
	12	18.44	4.19	21.76	5.16	25.89	6.22	27.26	6.76	28.97	7.31	32.31	8.42	35.72	9.54
	14	18.44	4.25	21.76	5.25	25.89	6.32	27.26	6.88	28.97	7.45	32.31	8.60	35.72	9.75
	16	18.44	4.32	21.76	5.33	25.89	6.44	27.26	7.00	28.97	7.57	32.31	8.74	35.72	9.85
	18	18.44	4.39	21.76	5.44	25.89	6.57	27.26	7.12	28.97	7.76	32.31	8.89	35.72	10.09
	20	18.44	4.51	21.76	5.59	25.89	6.75	27.26	7.36	28.97	7.91	32.31	9.14	35.72	10.30
	21	18.44	4.59	21.76	5.71	25.89	6.88	27.26	7.49	28.97	8.09	32.31	9.31	35.72	10.52
	23	18.44	4.74	21.76	5.89	25.89	7.14	27.26	7.73	28.97	8.38	32.31	9.63	35.60	10.61
	25	18.44	4.98	21.76	6.19	25.89	7.44	26.92	8.09	28.60	8.80	31.91	10.03	34.61	10.74
	27	18.44	5.19	21.76	6.48	25.89	7.82	26.57	8.45	28.24	9.15	31.50	10.48	33.57	10.80
	29	18.44	5.43	21.76	6.75	25.89	8.13	26.23	8.81	27.87	9.56	30.80	10.56	32.61	10.88
	31	18.44	5.65	21.76	7.03	25.43	8.44	25.89	9.18	27.51	9.91	29.87	10.52	31.61	10.83
	33	18.44	5.89	21.76	7.32	24.86	8.82	25.54	9.54	27.14	10.32	28.96	10.56	30.68	10.86
	35	18.44	6.09	21.76	7.62	24.74	9.14	25.20	9.90	26.38	10.25	28.07	10.54	29.70	10.84
	37	18.44	6.55	21.76	8.14	24.40	9.73	24.74	10.38	25.46	11.09	27.06	10.80	28.66	11.09
	39	18.44	7.08	21.42	8.82	24.05	10.51	24.28	10.75	24.50	10.93	26.07	11.23	27.59	11.53
42	18.44	7.79	20.85	9.66	23.18	10.93	23.83	11.11	23.40	11.29	24.84	11.59	26.33	11.95	
44	18.21	8.34	20.62	10.27	22.68	11.18	23.48	11.36	22.59	11.48	24.01	11.84	25.47	12.15	
46	18.10	8.95	20.39	11.04	22.18	11.53	23.02	11.71	21.74	11.89	23.08	12.20	24.46	12.57	
80	10	16.39	3.68	19.35	4.52	23.01	5.43	24.23	5.90	25.75	6.39	28.72	7.37	31.75	8.35
	12	16.39	3.73	19.35	4.59	23.01	5.52	24.23	6.01	25.75	6.50	28.72	7.49	31.75	8.48
	14	16.39	3.78	19.35	4.67	23.01	5.62	24.23	6.12	25.75	6.62	28.72	7.65	31.75	8.67
	16	16.39	3.84	19.35	4.74	23.01	5.72	24.23	6.22	25.75	6.73	28.72	7.77	31.75	8.75
	18	16.39	3.91	19.35	4.84	23.01	5.84	24.23	6.33	25.75	6.90	28.72	7.90	31.75	8.96
	20	16.39	4.01	19.35	4.97	23.01	6.00	24.23	6.55	25.75	7.03	28.72	8.12	31.75	9.15
	21	16.39	4.08	19.35	5.07	23.01	6.11	24.23	6.65	25.75	7.19	28.72	8.27	31.75	9.35
	23	16.39	4.21	19.35	5.23	23.01	6.34	24.23	6.87	25.75	7.45	28.72	8.56	31.64	9.43
	25	16.39	4.42	19.35	5.50	23.01	6.62	23.93	7.19	25.42	7.82	28.36	8.92	30.76	9.55
	27	16.39	4.61	19.35	5.76	23.01	6.95	23.62	7.51	25.10	8.13	28.00	9.32	29.84	9.60
	29	16.39	4.83	19.35	6.00	23.01	7.22	23.32	7.83	24.77	8.50	27.38	9.39	28.99	9.67
	31	16.39	5.02	19.35	6.25	22.60	7.50	23.01	8.16	24.45	8.81	26.56	9.35	28.10	9.62
	33	16.39	5.24	19.35	6.51	22.09	7.84	22.71	8.48	24.12	9.17	25.75	9.38	27.27	9.65
	35	16.39	5.42	19.35	6.77	21.99	8.12	22.40	8.80	23.45	9.11	24.95	9.37	26.40	9.63
	37	16.39	5.82	19.35	7.24	21.69	8.65	21.99	9.23	22.63	9.86	24.05	9.60	25.48	9.86
	39	16.39	6.30	19.04	7.84	21.38	9.34	21.59	9.55	21.78	9.71	23.18	9.98	24.52	10.24
42	16.39	6.92	18.53	8.59	20.61	9.71	21.18	9.87	20.80	10.03	22.08	10.30	23.40	10.62	
44	16.19	7.41	18.33	9.13	20.16	9.94	20.87	10.10	20.08	10.21	21.34	10.53	22.64	10.80	
46	16.09	7.96	18.12	9.81	19.71	10.25	20.47	10.41	19.32	10.57	20.51	10.85	21.74	11.17	



TC : Total capacity, PI : Power input

Combination, %(Capacity index)	Outdoor temperature (°C, DB)	Indoor temperature (°C, WB)													
		14		16		18		19		20		22		24	
		TC	PI	TC	PI	TC	PI	TC	PI	TC	PI	TC	PI	TC	PI
		kW	kW	kW	kW	kW	kW	kW	kW	kW	kW	kW	kW	kW	kW
70	10	14.34	3.22	16.93	3.96	20.13	4.75	21.20	5.16	22.53	5.59	25.13	6.45	27.78	7.30
	12	14.34	3.26	16.93	4.02	20.13	4.83	21.20	5.26	22.53	5.69	25.13	6.55	27.78	7.42
	14	14.34	3.31	16.93	4.09	20.13	4.92	21.20	5.35	22.53	5.79	25.13	6.69	27.78	7.59
	16	14.34	3.36	16.93	4.15	20.13	5.01	21.20	5.45	22.53	5.89	25.13	6.80	27.78	7.66
	18	14.34	3.42	16.93	4.23	20.13	5.11	21.20	5.54	22.53	6.03	25.13	6.91	27.78	7.84
	20	14.34	3.51	16.93	4.35	20.13	5.25	21.20	5.73	22.53	6.15	25.13	7.11	27.78	8.01
	21	14.34	3.57	16.93	4.44	20.13	5.35	21.20	5.82	22.53	6.29	25.13	7.24	27.78	8.18
	23	14.34	3.69	16.93	4.58	20.13	5.55	21.20	6.01	22.53	6.52	25.13	7.49	27.69	8.25
	25	14.34	3.87	16.93	4.81	20.13	5.79	20.94	6.29	22.24	6.85	24.82	7.80	26.92	8.36
	27	14.34	4.04	16.93	5.04	20.13	6.08	20.67	6.57	21.96	7.12	24.50	8.15	26.11	8.40
	29	14.34	4.22	16.93	5.25	20.13	6.32	20.40	6.85	21.68	7.44	23.95	8.22	25.37	8.46
	31	14.34	4.40	16.93	5.47	19.78	6.57	20.13	7.14	21.39	7.71	23.24	8.18	24.58	8.42
	33	14.34	4.58	16.93	5.69	19.33	6.86	19.87	7.42	21.11	8.02	22.53	8.21	23.86	8.44
	35	14.34	4.74	16.93	5.92	19.24	7.11	19.60	7.70	20.52	7.97	21.83	8.20	23.10	8.43
	37	14.34	5.09	16.93	6.33	18.98	7.57	19.24	8.08	19.80	8.63	21.05	8.40	22.29	8.63
	39	14.34	5.51	16.66	6.86	18.71	8.17	18.89	8.36	19.06	8.50	20.28	8.73	21.46	8.96
42	14.34	6.06	16.21	7.51	18.03	8.50	18.53	8.64	18.20	8.78	19.32	9.01	20.48	9.30	
44	14.17	6.49	16.04	7.99	17.64	8.70	18.26	8.84	17.57	8.93	18.67	9.21	19.81	9.45	
46	14.08	6.96	15.86	8.58	17.25	8.97	17.91	9.11	16.91	9.25	17.95	9.49	19.03	9.78	
60	10	12.29	2.76	14.51	3.39	17.26	4.07	18.17	4.43	19.31	4.79	21.54	5.53	23.81	6.26
	12	12.29	2.80	14.51	3.44	17.26	4.14	18.17	4.51	19.31	4.88	21.54	5.61	23.81	6.36
	14	12.29	2.84	14.51	3.50	17.26	4.21	18.17	4.59	19.31	4.97	21.54	5.73	23.81	6.50
	16	12.29	2.88	14.51	3.56	17.26	4.29	18.17	4.67	19.31	5.05	21.54	5.83	23.81	6.56
	18	12.29	2.93	14.51	3.63	17.26	4.38	18.17	4.75	19.31	5.17	21.54	5.92	23.81	6.72
	20	12.29	3.00	14.51	3.73	17.26	4.50	18.17	4.91	19.31	5.27	21.54	6.09	23.81	6.86
	23	12.29	3.16	14.51	3.92	17.26	4.76	18.17	5.15	19.31	5.59	21.54	6.42	23.73	7.07
	25	12.29	3.32	14.51	4.12	17.26	4.96	17.95	5.39	19.07	5.87	21.27	6.69	23.07	7.16
	27	12.29	3.46	14.51	4.32	17.26	5.21	17.72	5.63	18.82	6.10	21.00	6.99	22.38	7.20
	29	12.29	3.62	14.51	4.50	17.26	5.42	17.49	5.88	18.58	6.38	20.53	7.04	21.74	7.25
	31	12.29	3.77	14.51	4.69	16.95	5.63	17.26	6.12	18.34	6.61	19.92	7.01	21.07	7.22
	33	12.29	3.93	14.51	4.88	16.57	5.88	17.03	6.36	18.09	6.88	19.31	7.04	20.45	7.24
	35	12.29	4.06	14.51	5.08	16.49	6.09	16.80	6.60	17.59	6.83	18.71	7.03	19.80	7.22
	37	12.29	4.37	14.51	5.43	16.27	6.49	16.49	6.92	16.97	7.39	18.04	7.20	19.11	7.39
	39	12.29	4.72	14.28	5.88	16.04	7.00	16.19	7.16	16.33	7.28	17.38	7.48	18.39	7.68
	42	12.29	5.19	13.90	6.44	15.46	7.28	15.88	7.40	15.60	7.53	16.56	7.73	17.55	7.97
44	12.14	5.56	13.75	6.85	15.12	7.45	15.65	7.57	15.06	7.65	16.00	7.90	16.98	8.10	
46	12.07	5.97	13.59	7.36	14.78	7.68	15.35	7.81	14.49	7.93	15.38	8.13	16.31	8.38	
50	10	10.25	2.30	12.09	2.83	14.38	3.40	15.15	3.69	16.09	3.99	17.95	4.61	19.84	5.22
	12	10.25	2.33	12.09	2.87	14.38	3.45	15.15	3.76	16.09	4.06	17.95	4.68	19.84	5.30
	14	10.25	2.36	12.09	2.92	14.38	3.51	15.15	3.82	16.09	4.14	17.95	4.78	19.84	5.42
	16	10.25	2.40	12.09	2.96	14.38	3.58	15.15	3.89	16.09	4.20	17.95	4.86	19.84	5.47
	18	10.25	2.44	12.09	3.02	14.38	3.65	15.15	3.96	16.09	4.31	17.95	4.94	19.84	5.60
	20	10.25	2.50	12.09	3.11	14.38	3.75	15.15	4.09	16.09	4.39	17.95	5.08	19.84	5.72
	21	10.25	2.55	12.09	3.17	14.38	3.82	15.15	4.16	16.09	4.50	17.95	5.17	19.84	5.84
	23	10.25	2.63	12.09	3.27	14.38	3.97	15.15	4.29	16.09	4.66	17.95	5.35	19.78	5.89
	25	10.25	2.76	12.09	3.44	14.38	4.13	14.95	4.49	15.89	4.89	17.73	5.57	19.23	5.97
	27	10.25	2.88	12.09	3.60	14.38	4.34	14.76	4.70	15.69	5.08	17.50	5.82	18.65	6.00
	29	10.25	3.02	12.09	3.75	14.38	4.51	14.57	4.90	15.48	5.31	17.11	5.87	18.12	6.04
	31	10.25	3.14	12.09	3.91	14.13	4.69	14.38	5.10	15.28	5.51	16.60	5.85	17.56	6.02
	33	10.25	3.27	12.09	4.07	13.81	4.90	14.19	5.30	15.08	5.73	16.09	5.87	17.04	6.03
	35	10.25	3.38	12.09	4.23	13.75	5.08	14.00	5.50	14.66	5.70	15.59	5.86	16.50	6.02
	37	10.25	3.64	12.09	4.52	13.55	5.41	13.75	5.77	14.14	6.16	15.03	6.00	15.92	6.16
	39	10.25	3.94	11.90	4.90	13.36	5.84	13.49	5.97	13.61	6.07	14.48	6.24	15.33	6.40
42	10.25	4.33	11.58	5.37	12.88	6.07	13.24	6.17	13.00	6.27	13.80	6.44	14.63	6.64	
44	10.12	4.63	11.45	5.71	12.60	6.21	13.05	6.31	12.55	6.38	13.34	6.58	14.15	6.75	
46	10.05	4.97	11.33	6.13	12.32	6.40	12.79	6.51	12.08	6.61	12.82	6.78	13.59	6.98	



## 4. Capacity table

### (2) Heating

1) \*\*060\*\*

TC : Total capacity, PI : Power input

Combination, %(Capacity index)	Outdoor temperature		Indoor temperature (°C, DB)											
			16		18		20		21		22		24	
	°C, DB	°C, WB	TC	PI	TC	PI	TC	PI	TC	PI	TC	PI	TC	PI
100	-15	-14	11.9	5.0	11.7	5.4	11.5	5.5	11.3	5.7	11.2	5.8	11.2	5.8
	-12	-13	13.3	5.2	13.1	5.5	13.0	5.6	12.8	5.8	12.6	6.0	12.6	6.0
	-10	-11	14.9	5.4	14.6	5.7	14.2	5.8	14.0	6.0	13.9	6.1	13.9	6.1
	-7	-8	16.2	5.8	15.8	6.0	15.3	6.0	14.9	6.2	14.6	6.3	14.6	6.3
	-5	-6	17.5	6.1	16.7	6.2	16.2	6.3	15.8	6.4	15.5	6.5	15.5	6.5
	-3	-4	18.4	6.5	17.6	6.6	17.0	6.7	16.6	6.8	15.5	6.8	15.5	6.8
	0	-1	19.1	6.6	18.4	6.7	18.0	6.8	16.6	7.0	15.5	6.6	15.5	6.6
	3	2.2	19.4	6.3	19.1	6.4	18.0	6.5	16.6	6.6	15.5	6.2	15.5	6.2
	5	4.1	20.2	6.0	19.4	6.1	18.0	6.2	16.6	6.0	15.5	5.6	15.5	5.6
	7	6	20.7	5.7	19.4	5.8	18.0	5.9	16.6	5.5	15.5	5.1	15.5	5.1
	9	7.9	21.1	5.7	19.4	5.8	18.0	5.7	16.6	5.5	15.5	4.9	15.5	4.9
	11	9.8	21.1	5.9	19.4	6.0	18.0	5.6	16.6	5.2	15.5	4.8	15.5	4.8
	13	12	21.1	6.0	19.4	5.8	18.0	5.5	16.6	5.1	15.5	4.7	15.5	4.7
	15	14	21.1	6.0	19.4	5.7	18.0	5.3	16.6	4.9	15.5	4.5	15.5	4.5
	90	-15	-14	11.5	4.9	11.3	5.2	11.1	5.3	11.0	5.5	10.8	5.7	10.8
-12		-13	12.9	5.1	12.7	5.3	12.6	5.4	12.4	5.7	12.2	5.8	12.2	5.8
-10		-11	14.2	5.1	13.9	5.4	13.5	5.5	13.3	5.7	13.2	5.8	13.2	5.8
-7		-8	15.4	5.5	15.0	5.7	14.6	5.7	14.2	5.9	13.9	6.0	13.9	6.0
-5		-6	16.1	5.6	15.4	5.7	14.9	5.8	14.6	5.9	14.2	6.0	14.2	6.0
-3		-4	16.9	5.9	16.2	6.1	15.7	6.2	15.2	6.3	14.2	6.2	14.2	6.2
0		-1	17.6	6.1	16.9	6.2	16.6	6.3	15.2	6.4	14.2	6.1	14.2	6.1
3		2.2	17.5	5.7	17.2	5.8	16.2	5.9	14.9	5.9	13.9	5.6	13.9	5.6
5		4.1	18.1	5.4	17.5	5.5	16.2	5.6	14.9	5.4	13.9	5.1	13.9	5.1
7		6	18.6	5.1	17.5	5.2	16.2	5.3	14.9	5.0	13.9	4.6	13.9	4.6
9		7.9	19.0	5.2	17.5	5.3	16.2	5.1	14.9	4.8	13.9	4.4	13.9	4.4
11		9.8	19.0	5.3	17.5	5.4	16.2	5.0	14.9	4.7	13.9	4.3	13.9	4.3
13		12	19.0	5.4	17.5	5.3	16.2	4.9	14.9	4.6	13.9	4.2	13.9	4.2
15		14	19.0	5.4	17.5	5.1	16.2	4.8	14.9	4.4	13.9	4.0	13.9	4.0
80		-15	-14	11.3	4.8	11.1	5.1	10.9	5.2	10.8	5.4	10.6	5.5	10.6
	-12	-13	12.3	4.8	12.1	5.0	12.0	5.1	11.8	5.4	11.6	5.5	11.6	5.5
	-10	-11	13.7	5.0	13.4	5.2	13.1	5.3	12.9	5.5	12.8	5.6	12.8	5.6
	-7	-8	14.9	5.3	14.6	5.5	14.1	5.5	13.7	5.7	13.4	5.8	13.4	5.8
	-5	-6	16.1	5.6	15.4	5.7	14.9	5.8	14.6	5.9	14.2	6.0	14.2	6.0
	-3	-4	16.9	5.9	16.2	6.1	15.7	6.2	15.2	6.3	14.2	6.2	14.2	6.2
	0	-1	17.2	9.0	16.9	6.2	16.6	6.3	15.2	6.4	14.2	6.1	14.2	6.1
	3	2.2	15.6	5.0	15.3	5.1	14.4	5.2	13.2	5.3	12.4	4.9	12.4	4.9
	5	4.1	16.1	4.8	15.6	4.9	14.4	5.0	13.2	4.8	12.4	4.5	12.4	4.5
	7	6	16.6	4.6	15.6	4.6	14.4	4.7	13.2	4.4	12.4	4.1	12.4	4.1
	9	7.9	16.8	4.6	15.6	4.7	14.4	4.6	13.2	4.3	12.4	3.9	12.4	3.9
	11	9.8	16.8	4.7	15.6	4.8	14.4	4.5	13.2	4.2	12.4	3.8	12.4	3.8
	13	12	16.8	4.8	15.6	4.7	14.4	4.4	13.2	4.1	12.4	3.8	12.4	3.8
	15	14	16.8	4.8	15.6	4.5	14.4	4.2	13.2	3.9	12.4	3.6	12.4	3.6

2) \*\*100\*\*

TC : Total capacity, PI : Power input

Combination, %(Capacity index)	Outdoor temperature		Indoor temperature (°C, DB)											
			16		18		20		21		22		24	
	°C, DB	°C, WB	TC	PI	TC	PI	TC	PI	TC	PI	TC	PI	TC	PI
100	-15	-14	20.8	9.0	20.5	9.6	20.1	9.7	19.8	10.1	19.5	10.4	19.5	10.4
	-12	-13	23.3	9.3	23.0	9.7	22.8	9.9	22.4	10.4	22.1	10.7	22.1	10.7
	-10	-11	26.1	9.6	25.5	10.1	24.9	10.3	24.6	10.6	24.3	10.8	24.3	10.8
	-7	-8	28.4	10.3	27.7	10.6	26.8	10.7	26.1	11.1	25.5	11.3	25.5	11.3
	-5	-6	30.6	10.9	29.3	11.1	28.3	11.3	27.7	11.5	27.1	11.6	27.1	11.6
	-3	-4	32.1	11.5	30.9	11.7	29.8	11.9	29.0	12.2	27.1	12.0	27.1	12.0
	0	-1	33.4	11.8	32.1	11.9	31.5	12.2	29.0	12.4	27.1	11.8	27.1	11.8
	3	2.2	34.0	11.2	33.4	11.4	31.5	11.6	29.0	11.8	27.1	11.0	27.1	11.0
	5	4.1	35.3	10.7	34.0	10.9	31.5	11.1	29.0	10.8	27.1	10.0	27.1	10.0
	7	6	36.2	10.1	34.0	10.3	31.5	10.5	29.0	9.9	27.1	9.1	27.1	9.1
	9	7.9	36.9	10.2	34.0	10.4	31.5	10.2	29.0	9.5	27.1	8.8	27.1	8.8
	11	9.8	36.9	10.4	34.0	10.6	31.5	9.9	29.0	9.3	27.1	8.5	27.1	8.5
	13	12	36.9	10.6	34.0	10.4	31.5	9.7	29.0	9.1	27.1	8.3	27.1	8.3
	15	14	36.9	10.7	34.0	10.1	31.5	9.4	29.0	8.7	27.1	8.0	27.1	8.0
	90	-15	-14	20.2	8.7	19.9	9.3	19.5	9.4	19.2	9.8	18.9	10.1	18.9
-12		-13	22.6	9.0	22.3	9.4	22.1	9.6	21.7	10.1	21.4	10.4	21.4	10.4
-10		-11	24.8	9.1	24.2	9.6	23.6	9.8	23.3	10.1	23.0	10.3	23.0	10.3
-7		-8	26.9	9.8	26.3	10.1	25.5	10.2	24.8	10.5	24.2	10.7	24.2	10.7
-5		-6	28.1	10.0	27.0	10.2	26.0	10.4	25.5	10.6	24.9	10.7	24.9	10.7
-3		-4	29.6	10.6	28.4	10.8	27.4	11.0	26.7	11.2	24.9	11.1	24.9	11.1
0		-1	30.7	10.8	29.6	11.0	29.0	11.2	26.7	11.4	24.9	10.9	24.9	10.9
3		2.2	30.6	10.1	30.1	10.3	28.4	10.4	26.1	10.6	24.4	9.9	24.4	9.9
5		4.1	31.8	9.6	30.6	9.8	28.4	9.9	26.1	9.7	24.4	9.0	24.4	9.0
7		6	32.6	9.1	30.6	9.3	28.4	9.5	26.1	8.9	24.4	8.2	24.4	8.2
9		7.9	33.2	9.2	30.6	9.4	28.4	9.2	26.1	8.5	24.4	7.9	24.4	7.9
11		9.8	33.2	9.4	30.6	9.5	28.4	9.0	26.1	8.4	24.4	7.7	24.4	7.7
13		12	33.2	9.6	30.6	9.4	28.4	8.8	26.1	8.2	24.4	7.5	24.4	7.5
15		14	33.2	9.6	30.6	9.1	28.4	8.5	26.1	7.8	24.4	7.2	24.4	7.2
80		-15	-14	19.8	8.5	19.5	9.1	19.1	9.2	18.9	9.6	18.6	9.9	18.6
	-12	-13	21.4	8.5	21.2	8.9	20.9	9.2	20.6	9.6	20.3	9.9	20.3	9.9
	-10	-11	24.1	8.8	23.5	9.3	22.9	9.5	22.6	9.8	22.3	10.0	22.3	10.0
	-7	-8	26.1	9.5	25.5	9.8	24.7	9.9	24.1	10.2	23.5	10.4	23.5	10.4
	-5	-6	28.1	10.0	27.0	10.2	26.0	10.4	25.5	10.6	24.9	10.7	24.9	10.7
	-3	-4	29.6	10.6	28.4	10.8	27.4	11.0	26.7	11.2	24.9	11.1	24.9	11.1
	0	-1	30.1	9.0	29.6	11.0	29.0	11.2	26.7	11.4	24.9	10.9	24.9	10.9
	3	2.2	27.2	9.0	26.7	9.1	25.2	9.3	23.2	9.4	21.7	8.8	21.7	8.8
	5	4.1	28.2	8.5	27.2	8.7	25.2	8.8	23.2	8.6	21.7	8.0	21.7	8.0
	7	6	29.0	8.1	27.2	8.3	25.2	8.4	23.2	7.9	21.7	7.3	21.7	7.3
	9	7.9	29.5	8.2	27.2	8.3	25.2	8.1	23.2	7.6	21.7	7.0	21.7	7.0
	11	9.8	29.5	8.3	27.2	8.5	25.2	8.0	23.2	7.4	21.7	6.8	21.7	6.8
	13	12	29.5	8.5	27.2	8.3	25.2	7.8	23.2	7.2	21.7	6.7	21.7	6.7
	15	14	29.5	8.5	27.2	8.0	25.2	7.5	23.2	6.9	21.7	6.4	21.7	6.4



# 4. Capacity table

## 4-2. 60Hz

### (1) Cooling

1) \*\*050\*\*

TC : Total capacity, PI : Power input

Combination, %(Capacity index)	Outdoor temperature (°C, DB)	Indoor temperature (°C, WB)													
		14		16		18		19		20		22		24	
		TC	PI	TC	PI	TC	PI	TC	PI	TC	PI	TC	PI	TC	PI
		kW	kW	kW	kW	kW	kW	kW	kW	kW	kW	kW	kW	kW	kW
100	10	10.6	1.8	12.5	2.3	14.9	2.7	15.7	3.0	16.7	3.2	18.6	3.7	20.6	4.2
	12	10.6	1.9	12.5	2.3	14.9	2.8	15.7	3.0	16.7	3.3	18.6	3.7	20.6	4.2
	14	10.6	1.9	12.5	2.3	14.9	2.8	15.7	3.1	16.7	3.3	18.6	3.8	20.6	4.3
	16	10.6	1.9	12.5	2.4	14.9	2.9	15.7	3.1	16.7	3.4	18.6	3.9	20.6	4.4
	18	10.6	2.0	12.5	2.4	14.9	2.9	15.7	3.2	16.7	3.4	18.6	3.9	20.6	4.5
	20	10.6	2.0	12.5	2.5	14.9	3.0	15.7	3.3	16.7	3.5	18.6	4.1	20.6	4.6
	21	10.6	2.0	12.5	2.5	14.9	3.1	15.7	3.3	16.7	3.6	18.6	4.1	20.6	4.7
	23	10.6	2.1	12.5	2.6	14.9	3.2	15.7	3.4	16.7	3.7	18.6	4.3	20.5	4.7
	25	10.6	2.2	12.5	2.7	14.9	3.3	15.5	3.6	16.5	3.9	18.4	4.5	19.9	4.8
	27	10.6	2.3	12.5	2.9	14.9	3.5	15.3	3.8	16.2	4.1	18.1	4.7	19.3	4.8
	29	10.6	2.4	12.5	3.0	14.9	3.6	15.1	3.9	16.0	4.3	17.7	4.7	18.8	4.8
	31	10.6	2.5	12.5	3.1	14.6	3.8	14.9	4.1	15.8	4.4	17.2	4.7	18.2	4.8
	33	10.6	2.6	12.5	3.3	14.3	3.9	14.7	4.2	15.6	4.6	16.7	4.7	17.7	4.8
	35	10.6	2.7	12.5	3.4	14.2	4.1	14.5	4.4	15.2	4.6	16.2	4.7	17.1	4.8
	37	10.6	2.9	12.5	3.6	14.0	4.3	14.2	4.6	14.6	4.9	15.6	4.8	16.5	4.9
	39	10.6	3.1	12.3	3.9	13.8	4.7	14.0	4.8	14.1	4.9	15.0	5.0	15.9	5.1
42	10.6	3.5	12.0	4.3	13.3	4.9	13.7	4.9	13.5	5.0	14.3	5.2	15.1	5.3	
44	10.5	3.7	11.9	4.6	13.1	5.0	13.5	5.0	13.0	5.1	13.8	5.3	14.7	5.4	
46	10.4	4.0	11.7	4.9	12.8	5.1	13.2	5.2	12.5	5.3	13.3	5.4	14.1	5.6	
90	10	9.55	1.66	11.27	2.04	13.41	2.44	14.12	2.66	15.00	2.87	16.73	3.32	18.50	3.76
	12	9.55	1.68	11.27	2.07	13.41	2.49	14.12	2.70	15.00	2.93	16.73	3.37	18.50	3.82
	14	9.55	1.70	11.27	2.10	13.41	2.53	14.12	2.75	15.00	2.98	16.73	3.44	18.50	3.90
	16	9.55	1.73	11.27	2.13	13.41	2.57	14.12	2.80	15.00	3.03	16.73	3.50	18.50	3.94
	18	9.55	1.76	11.27	2.18	13.41	2.63	14.12	2.85	15.00	3.10	16.73	3.55	18.50	4.03
	20	9.55	1.80	11.27	2.24	13.41	2.70	14.12	2.95	15.00	3.16	16.73	3.66	18.50	4.12
	21	9.55	1.84	11.27	2.28	13.41	2.75	14.12	2.99	15.00	3.24	16.73	3.72	18.50	4.21
	23	9.55	1.90	11.27	2.35	13.41	2.85	14.12	3.09	15.00	3.35	16.73	3.85	18.43	4.24
	25	9.55	1.99	11.27	2.47	13.41	2.98	13.94	3.24	14.81	3.52	16.52	4.01	17.92	4.30
	27	9.55	2.08	11.27	2.59	13.41	3.13	13.76	3.38	14.62	3.66	16.31	4.19	17.39	4.32
	29	9.55	2.17	11.27	2.70	13.41	3.25	13.58	3.53	14.43	3.83	15.95	4.23	16.89	4.35
	31	9.55	2.26	11.27	2.81	13.17	3.38	13.41	3.67	14.24	3.96	15.47	4.21	16.37	4.33
	33	9.55	2.36	11.27	2.93	12.87	3.53	13.23	3.82	14.05	4.13	15.00	4.22	15.89	4.34
	35	9.55	2.44	11.27	3.05	12.81	3.66	13.05	3.96	13.66	4.10	14.54	4.22	15.38	4.33
	37	9.55	2.62	11.27	3.26	12.63	3.89	12.81	4.15	13.18	4.44	14.01	4.32	14.84	4.44
	39	9.55	2.83	11.09	3.53	12.46	4.20	12.58	4.30	12.69	4.37	13.50	4.49	14.29	4.61
42	9.55	3.11	10.80	3.86	12.01	4.37	12.34	4.44	12.12	4.52	12.86	4.64	13.63	4.78	
44	9.43	3.34	10.68	4.11	11.75	4.47	12.16	4.54	11.70	4.59	12.43	4.74	13.19	4.86	
46	9.37	3.58	10.56	4.41	11.48	4.61	11.92	4.68	11.26	4.76	11.95	4.88	12.67	5.03	
80	10	8.49	1.47	10.02	1.81	11.92	2.17	12.55	2.36	13.33	2.55	14.87	2.95	16.44	3.34
	12	8.49	1.49	10.02	1.84	11.92	2.21	12.55	2.40	13.33	2.60	14.87	2.99	16.44	3.39
	14	8.49	1.51	10.02	1.87	11.92	2.25	12.55	2.45	13.33	2.65	14.87	3.06	16.44	3.47
	16	8.49	1.54	10.02	1.90	11.92	2.29	12.55	2.49	13.33	2.69	14.87	3.11	16.44	3.50
	18	8.49	1.56	10.02	1.94	11.92	2.33	12.55	2.53	13.33	2.76	14.87	3.16	16.44	3.59
	20	8.49	1.60	10.02	1.99	11.92	2.40	12.55	2.62	13.33	2.81	14.87	3.25	16.44	3.66
	21	8.49	1.63	10.02	2.03	11.92	2.45	12.55	2.66	13.33	2.88	14.87	3.31	16.44	3.74
	23	8.49	1.69	10.02	2.09	11.92	2.54	12.55	2.75	13.33	2.98	14.87	3.42	16.39	3.77
	25	8.49	1.77	10.02	2.20	11.92	2.65	12.39	2.88	13.17	3.13	14.69	3.57	15.93	3.82
	27	8.49	1.85	10.02	2.30	11.92	2.78	12.23	3.00	13.00	3.25	14.50	3.73	15.45	3.84
	29	8.49	1.93	10.02	2.40	11.92	2.89	12.07	3.13	12.83	3.40	14.18	3.76	15.01	3.87
	31	8.49	2.01	10.02	2.50	11.71	3.00	11.92	3.26	12.66	3.52	13.75	3.74	14.55	3.85
	33	8.49	2.09	10.02	2.60	11.44	3.14	11.76	3.39	12.49	3.67	13.33	3.75	14.12	3.86
	35	8.49	2.17	10.02	2.71	11.39	3.25	11.60	3.52	12.14	3.64	12.92	3.75	13.67	3.85
	37	8.49	2.33	10.02	2.89	11.23	3.46	11.39	3.69	11.72	3.94	12.46	3.84	13.19	3.94
	39	8.49	2.52	9.86	3.14	11.07	3.74	11.18	3.82	11.28	3.88	12.00	3.99	12.70	4.10
42	8.49	2.77	9.60	3.43	10.67	3.88	10.97	3.95	10.77	4.01	11.43	4.12	12.12	4.25	
44	8.38	2.97	9.49	3.65	10.44	3.97	10.81	4.04	10.40	4.08	11.05	4.21	11.73	4.32	
46	8.33	3.18	9.39	3.92	10.21	4.10	10.60	4.16	10.01	4.23	10.62	4.34	11.26	4.47	

TC : Total capacity, PI : Power input

Combination, %(Capacity index)	Outdoor temperature (°C, DB)	Indoor temperature (°C, WB)													
		14		16		18		19		20		22		24	
		TC	PI	TC	PI	TC	PI	TC	PI	TC	PI	TC	PI	TC	PI
		kW	kW	kW	kW	kW	kW	kW	kW	kW	kW	kW	kW	kW	kW
70	10	7.43	1.29	8.77	1.58	10.43	1.90	10.98	2.07	11.67	2.24	13.01	2.58	14.39	2.92
	12	7.43	1.30	8.77	1.61	10.43	1.93	10.98	2.10	11.67	2.28	13.01	2.62	14.39	2.97
	14	7.43	1.32	8.77	1.63	10.43	1.97	10.98	2.14	11.67	2.32	13.01	2.68	14.39	3.03
	16	7.43	1.34	8.77	1.66	10.43	2.00	10.98	2.18	11.67	2.35	13.01	2.72	14.39	3.06
	18	7.43	1.37	8.77	1.69	10.43	2.04	10.98	2.22	11.67	2.41	13.01	2.76	14.39	3.14
	20	7.43	1.40	8.77	1.74	10.43	2.10	10.98	2.29	11.67	2.46	13.01	2.84	14.39	3.20
	21	7.43	1.43	8.77	1.77	10.43	2.14	10.98	2.33	11.67	2.52	13.01	2.90	14.39	3.27
	23	7.43	1.47	8.77	1.83	10.43	2.22	10.98	2.40	11.67	2.61	13.01	2.99	14.34	3.30
	25	7.43	1.55	8.77	1.92	10.43	2.32	10.84	2.52	11.52	2.74	12.85	3.12	13.94	3.34
	27	7.43	1.62	8.77	2.02	10.43	2.43	10.70	2.63	11.37	2.85	12.69	3.26	13.52	3.36
	29	7.43	1.69	8.77	2.10	10.43	2.53	10.57	2.74	11.23	2.98	12.40	3.29	13.14	3.38
	31	7.43	1.76	8.77	2.19	10.24	2.63	10.43	2.85	11.08	3.08	12.03	3.27	12.73	3.37
	33	7.43	1.83	8.77	2.28	10.01	2.74	10.29	2.97	10.93	3.21	11.67	3.28	12.36	3.38
	35	7.43	1.90	8.77	2.37	9.97	2.84	10.15	3.08	10.63	3.19	11.31	3.28	11.96	3.37
	37	7.43	2.04	8.77	2.53	9.83	3.03	9.97	3.23	10.25	3.45	10.90	3.36	11.54	3.45
	39	7.43	2.20	8.63	2.75	9.69	3.27	9.78	3.34	9.87	3.40	10.50	3.49	11.11	3.59
42	7.43	2.42	8.40	3.00	9.34	3.40	9.60	3.46	9.43	3.51	10.00	3.61	10.60	3.72	
44	7.34	2.59	8.30	3.20	9.14	3.48	9.46	3.53	9.10	3.57	9.67	3.68	10.26	3.78	
46	7.29	2.79	8.21	3.43	8.93	3.59	9.27	3.64	8.76	3.70	9.29	3.80	9.85	3.91	
60	10	6.37	1.10	7.51	1.36	8.94	1.63	9.41	1.77	10.00	1.92	11.16	2.21	12.33	2.50
	12	6.37	1.12	7.51	1.38	8.94	1.66	9.41	1.80	10.00	1.95	11.16	2.25	12.33	2.55
	14	6.37	1.13	7.51	1.40	8.94	1.69	9.41	1.84	10.00	1.99	11.16	2.29	12.33	2.60
	16	6.37	1.15	7.51	1.42	8.94	1.72	9.41	1.87	10.00	2.02	11.16	2.33	12.33	2.63
	18	6.37	1.17	7.51	1.45	8.94	1.75	9.41	1.90	10.00	2.07	11.16	2.37	12.33	2.69
	20	6.37	1.20	7.51	1.49	8.94	1.80	9.41	1.96	10.00	2.11	11.16	2.44	12.33	2.75
	21	6.37	1.22	7.51	1.52	8.94	1.83	9.41	2.00	10.00	2.16	11.16	2.48	12.33	2.81
	23	6.37	1.26	7.51	1.57	8.94	1.90	9.41	2.06	10.00	2.24	11.16	2.57	12.29	2.83
	25	6.37	1.33	7.51	1.65	8.94	1.98	9.29	2.16	9.87	2.35	11.01	2.67	11.95	2.86
	27	6.37	1.38	7.51	1.73	8.94	2.08	9.17	2.25	9.75	2.44	10.87	2.80	11.59	2.88
	29	6.37	1.45	7.51	1.80	8.94	2.17	9.06	2.35	9.62	2.55	10.63	2.82	11.26	2.90
	31	6.37	1.51	7.51	1.88	8.78	2.25	8.94	2.45	9.50	2.64	10.31	2.81	10.91	2.89
	33	6.37	1.57	7.51	1.95	8.58	2.35	8.82	2.54	9.37	2.75	10.00	2.82	10.59	2.90
	35	6.37	1.62	7.51	2.03	8.54	2.44	8.70	2.64	9.11	2.73	9.69	2.81	10.25	2.89
	37	6.37	1.75	7.51	2.17	8.42	2.60	8.54	2.77	8.79	2.96	9.34	2.88	9.90	2.96
	39	6.37	1.89	7.40	2.35	8.30	2.80	8.38	2.87	8.46	2.91	9.00	2.99	9.53	3.07
42	6.37	2.08	7.20	2.58	8.00	2.91	8.23	2.96	8.08	3.01	8.57	3.09	9.09	3.19	
44	6.29	2.22	7.12	2.74	7.83	2.98	8.11	3.03	7.80	3.06	8.29	3.16	8.79	3.24	
46	6.25	2.39	7.04	2.94	7.66	3.07	7.95	3.12	7.51	3.17	7.97	3.25	8.45	3.35	
50	10	5.31	0.92	6.26	1.13	7.45	1.36	7.84	1.48	8.33	1.60	9.30	1.84	10.28	2.09
	12	5.31	0.93	6.26	1.15	7.45	1.38	7.84	1.50	8.33	1.63	9.30	1.87	10.28	2.12
	14	5.31	0.95	6.26	1.17	7.45	1.40	7.84	1.53	8.33	1.66	9.30	1.91	10.28	2.17
	16	5.31	0.96	6.26	1.19	7.45	1.43	7.84	1.56	8.33	1.68	9.30	1.94	10.28	2.19
	18	5.31	0.98	6.26	1.21	7.45	1.46	7.84	1.58	8.33	1.72	9.30	1.97	10.28	2.24
	20	5.31	1.00	6.26	1.24	7.45	1.50	7.84	1.64	8.33	1.76	9.30	2.03	10.28	2.29
	21	5.31	1.02	6.26	1.27	7.45	1.53	7.84	1.66	8.33	1.80	9.30	2.07	10.28	2.34
	23	5.31	1.05	6.26	1.31	7.45	1.59	7.84	1.72	8.33	1.86	9.30	2.14	10.24	2.36
	25	5.31	1.11	6.26	1.37	7.45	1.65	7.74	1.80	8.23	1.96	9.18	2.23	9.96	2.39
	27	5.31	1.15	6.26	1.44	7.45	1.74	7.65	1.88	8.12	2.03	9.06	2.33	9.66	2.40
	29	5.31	1.21	6.26	1.50	7.45	1.81	7.55	1.96	8.02	2.13	8.86	2.35	9.38	2.42
	31	5.31	1.26	6.26	1.56	7.32	1.88	7.45	2.04	7.91	2.20	8.59	2.34	9.09	2.41
	33	5.31	1.31	6.26	1.63	7.15	1.96	7.35	2.12	7.81	2.29	8.33	2.35	8.83	2.41
	35	5.31	1.35	6.26	1.69	7.12	2.03	7.25	2.20	7.59	2.28	8.08	2.34	8.54	2.41
	37	5.31	1.46	6.26	1.81	7.02	2.16	7.12	2.31	7.32	2.46	7.79	2.40	8.25	2.46
	39	5.31	1.57	6.16	1.96	6.92	2.33	6.99	2.39	7.05	2.43	7.50	2.49	7.94	2.56
42	5.31	1.73	6.00	2.15	6.67	2.43	6.85	2.47	6.73	2.51	7.15	2.58	7.57	2.66	
44	5.24	1.85	5.93	2.28	6.53	2.48	6.76	2.52	6.50	2.55	6.91	2.63	7.33	2.70	
46	5.21	1.99	5.87	2.45	6.38	2.56	6.62	2.60	6.25	2.64	6.64	2.71	7.04	2.79	



## 4. Capacity table

2) \*\*060\*\*

TC : Total capacity, PI : Power input

Combination, %(Capacity index)	Outdoor temperature (°C, DB)	Indoor temperature (°C, WB)													
		14		16		18		19		20		22		24	
		TC	PI	TC	PI	TC	PI	TC	PI	TC	PI	TC	PI	TC	PI
		kW	kW	kW	kW	kW	kW	kW	kW	kW	kW	kW	kW	kW	kW
100	10	11.7	2.9	13.8	3.6	16.4	4.3	17.3	4.7	18.4	5.1	20.5	5.9	22.7	6.6
	12	11.7	3.0	13.8	3.7	16.4	4.4	17.3	4.8	18.4	5.2	20.5	6.0	22.7	6.7
	14	11.7	3.0	13.8	3.7	16.4	4.5	17.3	4.9	18.4	5.3	20.5	6.1	22.7	6.9
	16	11.7	3.1	13.8	3.8	16.4	4.6	17.3	5.0	18.4	5.4	20.5	6.2	22.7	7.0
	18	11.7	3.1	13.8	3.8	16.4	4.6	17.3	5.0	18.4	5.5	20.5	6.3	22.7	7.1
	20	11.7	3.2	13.8	4.0	16.4	4.8	17.3	5.2	18.4	5.6	20.5	6.5	22.7	7.3
	21	11.7	3.2	13.8	4.0	16.4	4.9	17.3	5.3	18.4	5.7	20.5	6.6	22.7	7.4
	23	11.7	3.4	13.8	4.2	16.4	5.0	17.3	5.5	18.4	5.9	20.5	6.8	22.6	7.5
	25	11.7	3.5	13.8	4.4	16.4	5.3	17.1	5.7	18.2	6.2	20.3	7.1	22.0	7.6
	27	11.7	3.7	13.8	4.6	16.4	5.5	16.9	6.0	17.9	6.5	20.0	7.4	21.3	7.6
	29	11.7	3.8	13.8	4.8	16.4	5.7	16.7	6.2	17.7	6.8	19.6	7.5	20.7	7.7
	31	11.7	4.0	13.8	5.0	16.1	6.0	16.4	6.5	17.5	7.0	19.0	7.4	20.1	7.7
	33	11.7	4.2	13.8	5.2	15.8	6.2	16.2	6.7	17.2	7.3	18.4	7.5	19.5	7.7
	35	11.7	4.3	13.8	5.4	15.7	6.5	16.0	7.0	16.8	7.2	17.8	7.5	18.9	7.7
	37	11.7	4.6	13.8	5.8	15.5	6.9	15.7	7.3	16.2	7.8	17.2	7.6	18.2	7.8
	39	11.7	5.0	13.6	6.2	15.3	7.4	15.4	7.6	15.6	7.7	16.6	7.9	17.5	8.1
42	11.7	5.5	13.2	6.8	14.7	7.7	15.1	7.9	14.9	8.0	15.8	8.2	16.7	8.5	
44	11.6	5.9	13.1	7.3	14.4	7.9	14.9	8.0	14.3	8.1	15.2	8.4	16.2	8.6	
46	11.5	6.3	12.9	7.8	14.1	8.2	14.6	8.3	13.8	8.4	14.7	8.6	15.5	8.9	
90	10	10.54	2.64	12.44	3.24	14.79	3.89	15.58	4.23	16.55	4.57	18.46	5.28	20.41	5.98
	12	10.54	2.67	12.44	3.29	14.79	3.96	15.58	4.30	16.55	4.65	18.46	5.36	20.41	6.07
	14	10.54	2.71	12.44	3.34	14.79	4.02	15.58	4.38	16.55	4.74	18.46	5.47	20.41	6.21
	16	10.54	2.75	12.44	3.39	14.79	4.10	15.58	4.46	16.55	4.82	18.46	5.56	20.41	6.27
	18	10.54	2.80	12.44	3.46	14.79	4.18	15.58	4.53	16.55	4.94	18.46	5.65	20.41	6.42
	20	10.54	2.87	12.44	3.56	14.79	4.30	15.58	4.69	16.55	5.03	18.46	5.81	20.41	6.55
	21	10.54	2.92	12.44	3.63	14.79	4.38	15.58	4.76	16.55	5.15	18.46	5.92	20.41	6.69
	23	10.54	3.02	12.44	3.75	14.79	4.54	15.58	4.92	16.55	5.33	18.46	6.13	20.34	6.75
	25	10.54	3.17	12.44	3.94	14.79	4.74	15.38	5.15	16.34	5.60	18.23	6.38	19.78	6.84
	27	10.54	3.30	12.44	4.12	14.79	4.97	15.19	5.38	16.13	5.82	18.00	6.67	19.19	6.87
	29	10.54	3.46	12.44	4.30	14.79	5.17	14.99	5.61	15.93	6.09	17.60	6.72	18.64	6.92
	31	10.54	3.60	12.44	4.48	14.53	5.37	14.79	5.84	15.72	6.31	17.07	6.70	18.06	6.89
	33	10.54	3.75	12.44	4.66	14.20	5.61	14.60	6.07	15.51	6.57	16.55	6.72	17.53	6.91
	35	10.54	3.88	12.44	4.85	14.14	5.82	14.40	6.30	15.08	6.52	16.04	6.71	16.97	6.90
	37	10.54	4.17	12.44	5.18	13.94	6.19	14.14	6.61	14.55	7.06	15.46	6.87	16.38	7.06
	39	10.54	4.51	12.24	5.62	13.75	6.69	13.88	6.84	14.00	6.95	14.90	7.14	15.77	7.33
42	10.54	4.96	11.91	6.15	13.25	6.95	13.61	7.07	13.37	7.18	14.19	7.38	15.04	7.61	
44	10.41	5.31	11.78	6.54	12.96	7.11	13.42	7.23	12.91	7.31	13.72	7.54	14.56	7.73	
46	10.34	5.70	11.65	7.02	12.67	7.34	13.16	7.45	12.42	7.57	13.19	7.76	13.98	8.00	
80	10	9.37	2.34	11.05	2.88	13.15	3.46	13.85	3.76	14.71	4.06	16.41	4.69	18.14	5.31
	12	9.37	2.37	11.05	2.92	13.15	3.52	13.85	3.82	14.71	4.14	16.41	4.76	18.14	5.40
	14	9.37	2.41	11.05	2.97	13.15	3.58	13.85	3.89	14.71	4.21	16.41	4.87	18.14	5.52
	16	9.37	2.44	11.05	3.02	13.15	3.64	13.85	3.96	14.71	4.28	16.41	4.95	18.14	5.57
	18	9.37	2.49	11.05	3.08	13.15	3.71	13.85	4.03	14.71	4.39	16.41	5.03	18.14	5.70
	20	9.37	2.55	11.05	3.16	13.15	3.82	13.85	4.17	14.71	4.47	16.41	5.17	18.14	5.82
	21	9.37	2.60	11.05	3.23	13.15	3.89	13.85	4.23	14.71	4.58	16.41	5.26	18.14	5.95
	23	9.37	2.68	11.05	3.33	13.15	4.04	13.85	4.37	14.71	4.74	16.41	5.44	18.08	6.00
	25	9.37	2.81	11.05	3.50	13.15	4.21	13.67	4.58	14.53	4.98	16.21	5.67	17.58	6.08
	27	9.37	2.94	11.05	3.67	13.15	4.42	13.50	4.78	14.34	5.18	16.00	5.93	17.05	6.11
	29	9.37	3.07	11.05	3.82	13.15	4.60	13.32	4.99	14.16	5.41	15.64	5.98	16.57	6.15
	31	9.37	3.20	11.05	3.98	12.92	4.78	13.15	5.19	13.97	5.61	15.17	5.95	16.05	6.12
	33	9.37	3.33	11.05	4.14	12.63	4.99	12.97	5.40	13.79	5.84	14.71	5.97	15.58	6.14
	35	9.37	3.45	11.05	4.31	12.57	5.17	12.80	5.60	13.40	5.80	14.26	5.96	15.09	6.13
	37	9.37	3.70	11.05	4.61	12.39	5.51	12.57	5.87	12.93	6.27	13.75	6.11	14.56	6.27
	39	9.37	4.01	10.88	4.99	12.22	5.94	12.33	6.08	12.44	6.18	13.24	6.35	14.01	6.52
42	9.37	4.40	10.59	5.46	11.78	6.18	12.10	6.28	11.89	6.39	12.62	6.56	13.37	6.76	
44	9.25	4.72	10.47	5.81	11.52	6.32	11.93	6.43	11.47	6.49	12.19	6.70	12.94	6.87	
46	9.19	5.06	10.36	6.24	11.26	6.52	11.69	6.62	11.04	6.73	11.72	6.90	12.43	7.11	

TC : Total capacity, PI : Power input

Combination, %(Capacity index)	Outdoor temperature (°C, DB)	Indoor temperature (°C, WB)													
		14		16		18		19		20		22		24	
		TC	PI	TC	PI	TC	PI	TC	PI	TC	PI	TC	PI	TC	PI
		kW	kW	kW	kW	kW	kW	kW	kW	kW	kW	kW	kW	kW	kW
70	10	8.20	2.05	9.67	2.52	11.51	3.03	12.12	3.29	12.87	3.56	14.36	4.10	15.88	4.65
	12	8.20	2.08	9.67	2.56	11.51	3.08	12.12	3.35	12.87	3.62	14.36	4.17	15.88	4.72
	14	8.20	2.11	9.67	2.60	11.51	3.13	12.12	3.41	12.87	3.69	14.36	4.26	15.88	4.83
	16	8.20	2.14	9.67	2.64	11.51	3.19	12.12	3.47	12.87	3.75	14.36	4.33	15.88	4.87
	18	8.20	2.17	9.67	2.69	11.51	3.25	12.12	3.53	12.87	3.84	14.36	4.40	15.88	4.99
	20	8.20	2.23	9.67	2.77	11.51	3.34	12.12	3.65	12.87	3.92	14.36	4.52	15.88	5.10
	21	8.20	2.27	9.67	2.82	11.51	3.40	12.12	3.70	12.87	4.01	14.36	4.61	15.88	5.21
	23	8.20	2.35	9.67	2.91	11.51	3.53	12.12	3.82	12.87	4.15	14.36	4.76	15.82	5.25
	25	8.20	2.46	9.67	3.06	11.51	3.68	11.96	4.00	12.71	4.36	14.18	4.96	15.38	5.32
	27	8.20	2.57	9.67	3.21	11.51	3.87	11.81	4.18	12.55	4.53	14.00	5.19	14.92	5.35
	29	8.20	2.69	9.67	3.34	11.51	4.02	11.66	4.36	12.39	4.73	13.69	5.23	14.49	5.38
	31	8.20	2.80	9.67	3.48	11.30	4.18	11.51	4.54	12.22	4.90	13.28	5.21	14.05	5.36
	33	8.20	2.92	9.67	3.62	11.05	4.36	11.35	4.72	12.06	5.11	12.87	5.23	13.63	5.37
	35	8.20	3.02	9.67	3.77	11.00	4.52	11.20	4.90	11.73	5.07	12.48	5.22	13.20	5.36
	37	8.20	3.24	9.67	4.03	10.84	4.82	11.00	5.14	11.32	5.49	12.03	5.34	12.74	5.49
	39	8.20	3.51	9.52	4.37	10.69	5.20	10.79	5.32	10.89	5.41	11.59	5.56	12.26	5.70
	42	8.20	3.85	9.27	4.78	10.30	5.41	10.59	5.50	10.40	5.59	11.04	5.74	11.70	5.92
44	8.09	4.13	9.16	5.08	10.08	5.53	10.44	5.62	10.04	5.68	10.67	5.86	11.32	6.01	
46	8.04	4.43	9.06	5.46	9.86	5.71	10.23	5.80	9.66	5.89	10.26	6.04	10.87	6.22	
60	10	7.03	1.76	8.29	2.16	9.86	2.59	10.39	2.82	11.03	3.05	12.31	3.52	13.61	3.98
	12	7.03	1.78	8.29	2.19	9.86	2.64	10.39	2.87	11.03	3.10	12.31	3.57	13.61	4.05
	14	7.03	1.81	8.29	2.23	9.86	2.68	10.39	2.92	11.03	3.16	12.31	3.65	13.61	4.14
	16	7.03	1.83	8.29	2.26	9.86	2.73	10.39	2.97	11.03	3.21	12.31	3.71	13.61	4.18
	18	7.03	1.86	8.29	2.31	9.86	2.79	10.39	3.02	11.03	3.29	12.31	3.77	13.61	4.28
	20	7.03	1.91	8.29	2.37	9.86	2.86	10.39	3.12	11.03	3.36	12.31	3.88	13.61	4.37
	21	7.03	1.95	8.29	2.42	9.86	2.92	10.39	3.18	11.03	3.43	12.31	3.95	13.61	4.46
	23	7.03	2.01	8.29	2.50	9.86	3.03	10.39	3.28	11.03	3.56	12.31	4.08	13.56	4.50
	25	7.03	2.11	8.29	2.62	9.86	3.16	10.25	3.43	10.90	3.73	12.15	4.26	13.18	4.56
	27	7.03	2.20	8.29	2.75	9.86	3.32	10.12	3.59	10.76	3.88	12.00	4.45	12.79	4.58
	29	7.03	2.30	8.29	2.86	9.86	3.45	9.99	3.74	10.62	4.06	11.73	4.48	12.42	4.61
	31	7.03	2.40	8.29	2.98	9.69	3.58	9.86	3.89	10.48	4.20	11.38	4.46	12.04	4.59
	33	7.03	2.50	8.29	3.10	9.47	3.74	9.73	4.05	10.34	4.38	11.03	4.48	11.69	4.61
	35	7.03	2.58	8.29	3.23	9.43	3.88	9.60	4.20	10.05	4.35	10.69	4.47	11.31	4.60
	37	7.03	2.78	8.29	3.45	9.29	4.13	9.43	4.40	9.70	4.71	10.31	4.58	10.92	4.71
	39	7.03	3.01	8.16	3.74	9.16	4.46	9.25	4.56	9.33	4.63	9.93	4.76	10.51	4.89
	42	7.03	3.30	7.94	4.10	8.83	4.64	9.08	4.71	8.91	4.79	9.46	4.92	10.03	5.07
44	6.94	3.54	7.85	4.36	8.64	4.74	8.95	4.82	8.61	4.87	9.15	5.02	9.70	5.15	
46	6.89	3.80	7.77	4.68	8.45	4.89	8.77	4.97	8.28	5.05	8.79	5.18	9.32	5.33	
50	10	5.85	1.46	6.91	1.80	8.22	2.16	8.65	2.35	9.20	2.54	10.26	2.93	11.34	3.32
	12	5.85	1.48	6.91	1.83	8.22	2.20	8.65	2.39	9.20	2.59	10.26	2.98	11.34	3.37
	14	5.85	1.50	6.91	1.86	8.22	2.23	8.65	2.43	9.20	2.63	10.26	3.04	11.34	3.45
	16	5.85	1.53	6.91	1.89	8.22	2.28	8.65	2.48	9.20	2.68	10.26	3.09	11.34	3.48
	18	5.85	1.55	6.91	1.92	8.22	2.32	8.65	2.52	9.20	2.74	10.26	3.14	11.34	3.57
	20	5.85	1.59	6.91	1.98	8.22	2.39	8.65	2.60	9.20	2.80	10.26	3.23	11.34	3.64
	21	5.85	1.62	6.91	2.02	8.22	2.43	8.65	2.65	9.20	2.86	10.26	3.29	11.34	3.72
	23	5.85	1.68	6.91	2.08	8.22	2.52	8.65	2.73	9.20	2.96	10.26	3.40	11.30	3.75
	25	5.85	1.76	6.91	2.19	8.22	2.63	8.55	2.86	9.08	3.11	10.13	3.55	10.99	3.80
	27	5.85	1.84	6.91	2.29	8.22	2.76	8.44	2.99	8.96	3.23	10.00	3.71	10.66	3.82
	29	5.85	1.92	6.91	2.39	8.22	2.87	8.33	3.12	8.85	3.38	9.78	3.73	10.35	3.85
	31	5.85	2.00	6.91	2.49	8.07	2.98	8.22	3.24	8.73	3.50	9.48	3.72	10.03	3.83
	33	5.85	2.08	6.91	2.59	7.89	3.12	8.11	3.37	8.62	3.65	9.20	3.73	9.74	3.84
	35	5.85	2.15	6.91	2.69	7.85	3.23	8.00	3.50	8.38	3.62	8.91	3.73	9.43	3.83
	37	5.85	2.32	6.91	2.88	7.75	3.44	7.85	3.67	8.08	3.92	8.59	3.82	9.10	3.92
	39	5.85	2.50	6.80	3.12	7.64	3.71	7.71	3.80	7.78	3.86	8.28	3.97	8.76	4.07
	42	5.85	2.75	6.62	3.41	7.36	3.86	7.56	3.93	7.43	3.99	7.88	4.10	8.36	4.23
44	5.78	2.95	6.55	3.63	7.20	3.95	7.45	4.02	7.17	4.06	7.62	4.19	8.09	4.29	
46	5.75	3.16	6.47	3.90	7.04	4.08	7.31	4.14	6.90	4.21	7.33	4.31	7.77	4.44	



## 4. Capacity table

3) \*\*072\*\*

TC : Total capacity, PI : Power input

Combination, %(Capacity index)	Outdoor temperature (°C, DB)	Indoor temperature (°C, WB)													
		14		16		18		19		20		22		24	
		TC	PI	TC	PI	TC	PI	TC	PI	TC	PI	TC	PI	TC	PI
		kW	kW	kW	kW	kW	kW	kW	kW	kW	kW	kW	kW	kW	kW
100	10	15.2	3.0	18.0	3.6	21.4	4.4	22.5	4.8	23.9	5.2	26.7	5.9	29.5	6.7
	12	15.2	3.0	18.0	3.7	21.4	4.5	22.5	4.8	23.9	5.2	26.7	6.0	29.5	6.8
	14	15.2	3.1	18.0	3.8	21.4	4.5	22.5	4.9	23.9	5.3	26.7	6.2	29.5	7.0
	16	15.2	3.1	18.0	3.8	21.4	4.6	22.5	5.0	23.9	5.4	26.7	6.3	29.5	7.1
	18	15.2	3.2	18.0	3.9	21.4	4.7	22.5	5.1	23.9	5.6	26.7	6.4	29.5	7.2
	20	15.2	3.2	18.0	4.0	21.4	4.8	22.5	5.3	23.9	5.7	26.7	6.6	29.5	7.4
	21	15.2	3.3	18.0	4.1	21.4	4.9	22.5	5.4	23.9	5.8	26.7	6.7	29.5	7.5
	23	15.2	3.4	18.0	4.2	21.4	5.1	22.5	5.5	23.9	6.0	26.7	6.9	29.4	7.6
	25	15.2	3.6	18.0	4.4	21.4	5.3	22.2	5.8	23.6	6.3	26.3	7.2	28.6	7.7
	27	15.2	3.7	18.0	4.6	21.4	5.6	21.9	6.1	23.3	6.6	26.0	7.5	27.7	7.7
	29	15.2	3.9	18.0	4.8	21.4	5.8	21.7	6.3	23.0	6.9	25.4	7.6	26.9	7.8
	31	15.2	4.1	18.0	5.0	21.0	6.1	21.4	6.6	22.7	7.1	24.7	7.5	26.1	7.8
	33	15.2	4.2	18.0	5.2	20.5	6.3	21.1	6.8	22.4	7.4	23.9	7.6	25.3	7.8
	35	15.2	4.4	18.0	5.5	20.4	6.6	20.8	7.1	21.8	7.4	23.2	7.6	24.5	7.8
	37	15.2	4.7	18.0	5.8	20.1	7.0	20.4	7.4	21.0	8.0	22.3	7.7	23.7	8.0
	39	15.2	5.1	17.7	6.3	19.9	7.5	20.0	7.7	20.2	7.8	21.5	8.1	22.8	8.3
42	15.2	5.6	17.2	6.9	19.1	7.8	19.7	8.0	19.3	8.1	20.5	8.3	21.7	8.6	
44	15.0	6.0	17.0	7.4	18.7	8.0	19.4	8.1	18.6	8.2	19.8	8.5	21.0	8.7	
46	14.9	6.4	16.8	7.9	18.3	8.3	19.0	8.4	17.9	8.5	19.0	8.8	20.2	9.0	
90	10	13.70	2.67	16.17	3.28	19.23	3.95	20.25	4.29	21.52	4.64	24.00	5.35	26.54	6.06
	12	13.70	2.71	16.17	3.33	19.23	4.01	20.25	4.36	21.52	4.72	24.00	5.44	26.54	6.16
	14	13.70	2.75	16.17	3.39	19.23	4.08	20.25	4.44	21.52	4.81	24.00	5.55	26.54	6.30
	16	13.70	2.79	16.17	3.44	19.23	4.15	20.25	4.52	21.52	4.88	24.00	5.64	26.54	6.36
	18	13.70	2.84	16.17	3.51	19.23	4.24	20.25	4.60	21.52	5.01	24.00	5.74	26.54	6.51
	20	13.70	2.91	16.17	3.61	19.23	4.36	20.25	4.75	21.52	5.11	24.00	5.90	26.54	6.65
	21	13.70	2.96	16.17	3.68	19.23	4.44	20.25	4.83	21.52	5.22	24.00	6.01	26.54	6.79
	23	13.70	3.06	16.17	3.80	19.23	4.61	20.25	4.99	21.52	5.41	24.00	6.21	26.44	6.85
	25	13.70	3.21	16.17	3.99	19.23	4.80	20.00	5.22	21.25	5.68	23.70	6.47	25.71	6.93
	27	13.70	3.35	16.17	4.18	19.23	5.04	19.74	5.45	20.97	5.91	23.40	6.77	24.94	6.97
	29	13.70	3.51	16.17	4.36	19.23	5.24	19.49	5.69	20.70	6.17	22.88	6.82	24.23	7.02
	31	13.70	3.65	16.17	4.54	18.89	5.45	19.23	5.92	20.43	6.40	22.19	6.79	23.48	6.99
	33	13.70	3.80	16.17	4.72	18.46	5.69	18.98	6.16	20.16	6.66	21.52	6.81	22.79	7.01
	35	13.70	3.93	16.17	4.92	18.38	5.90	18.72	6.39	19.60	6.62	20.85	6.81	22.06	6.99
	37	13.70	4.23	16.17	5.25	18.12	6.28	18.38	6.70	18.91	7.16	20.10	6.97	21.29	7.16
	39	13.70	4.57	15.91	5.70	17.87	6.78	18.04	6.94	18.20	7.05	19.37	7.25	20.50	7.44
42	13.70	5.03	15.49	6.23	17.22	7.05	17.70	7.17	17.38	7.29	18.45	7.48	19.56	7.71	
44	13.53	5.38	15.32	6.63	16.85	7.22	17.44	7.33	16.78	7.41	17.83	7.64	18.92	7.84	
46	13.44	5.78	15.15	7.12	16.47	7.44	17.10	7.56	16.15	7.68	17.14	7.88	18.17	8.11	
80	10	12.18	2.38	14.37	2.92	17.09	3.51	18.00	3.81	19.13	4.12	21.34	4.76	23.59	5.39
	12	12.18	2.41	14.37	2.96	17.09	3.57	18.00	3.88	19.13	4.20	21.34	4.83	23.59	5.48
	14	12.18	2.44	14.37	3.01	17.09	3.63	18.00	3.95	19.13	4.27	21.34	4.94	23.59	5.60
	16	12.18	2.48	14.37	3.06	17.09	3.69	18.00	4.02	19.13	4.34	21.34	5.02	23.59	5.65
	18	12.18	2.52	14.37	3.12	17.09	3.77	18.00	4.09	19.13	4.45	21.34	5.10	23.59	5.79
	20	12.18	2.59	14.37	3.21	17.09	3.87	18.00	4.23	19.13	4.54	21.34	5.24	23.59	5.91
	21	12.18	2.63	14.37	3.27	17.09	3.95	18.00	4.29	19.13	4.64	21.34	5.34	23.59	6.04
	23	12.18	2.72	14.37	3.38	17.09	4.10	18.00	4.43	19.13	4.81	21.34	5.52	23.51	6.09
	25	12.18	2.86	14.37	3.55	17.09	4.27	17.77	4.64	18.89	5.05	21.07	5.75	22.85	6.16
	27	12.18	2.98	14.37	3.72	17.09	4.48	17.55	4.85	18.64	5.25	20.80	6.02	22.17	6.20
	29	12.18	3.12	14.37	3.87	17.09	4.66	17.32	5.06	18.40	5.49	20.34	6.06	21.53	6.24
	31	12.18	3.24	14.37	4.04	16.79	4.84	17.09	5.26	18.16	5.69	19.73	6.04	20.87	6.21
	33	12.18	3.38	14.37	4.20	16.41	5.06	16.87	5.47	17.92	5.92	19.13	6.06	20.26	6.23
	35	12.18	3.50	14.37	4.37	16.34	5.24	16.64	5.68	17.42	5.88	18.53	6.05	19.61	6.22
	37	12.18	3.76	14.37	4.67	16.11	5.58	16.34	5.96	16.81	6.36	17.87	6.19	18.93	6.36
	39	12.18	4.06	14.14	5.06	15.88	6.03	16.03	6.16	16.18	6.27	17.22	6.44	18.22	6.61
42	12.18	4.47	13.77	5.54	15.31	6.27	15.73	6.37	15.45	6.48	16.40	6.65	17.38	6.86	
44	12.03	4.78	13.61	5.89	14.98	6.41	15.51	6.52	14.92	6.59	15.85	6.80	16.82	6.97	
46	11.95	5.14	13.46	6.33	14.64	6.61	15.20	6.72	14.35	6.82	15.24	7.00	16.15	7.21	



TC : Total capacity, PI : Power input

Combination, %(Capacity index)	Outdoor temperature (°C, DB)	Indoor temperature (°C, WB)													
		14		16		18		19		20		22		24	
		TC	PI	TC	PI	TC	PI	TC	PI	TC	PI	TC	PI	TC	PI
		kW	kW	kW	kW	kW	kW	kW	kW	kW	kW	kW	kW	kW	kW
70	10	10.66	2.08	12.57	2.55	14.96	3.07	15.75	3.33	16.74	3.61	18.67	4.16	20.64	4.71
	12	10.66	2.11	12.57	2.59	14.96	3.12	15.75	3.39	16.74	3.67	18.67	4.23	20.64	4.79
	14	10.66	2.14	12.57	2.64	14.96	3.17	15.75	3.45	16.74	3.74	18.67	4.32	20.64	4.90
	16	10.66	2.17	12.57	2.68	14.96	3.23	15.75	3.52	16.74	3.80	18.67	4.39	20.64	4.94
	18	10.66	2.21	12.57	2.73	14.96	3.30	15.75	3.58	16.74	3.89	18.67	4.46	20.64	5.06
	20	10.66	2.26	12.57	2.81	14.96	3.39	15.75	3.70	16.74	3.97	18.67	4.59	20.64	5.17
	21	10.66	2.31	12.57	2.86	14.96	3.45	15.75	3.76	16.74	4.06	18.67	4.67	20.64	5.28
	23	10.66	2.38	12.57	2.96	14.96	3.58	15.75	3.88	16.74	4.21	18.67	4.83	20.57	5.33
	25	10.66	2.50	12.57	3.11	14.96	3.74	15.55	4.06	16.52	4.42	18.43	5.04	20.00	5.39
	27	10.66	2.61	12.57	3.25	14.96	3.92	15.35	4.24	16.31	4.59	18.20	5.26	19.40	5.42
	29	10.66	2.73	12.57	3.39	14.96	4.08	15.16	4.42	16.10	4.80	17.79	5.30	18.84	5.46
	31	10.66	2.84	12.57	3.53	14.69	4.24	14.96	4.61	15.89	4.97	17.26	5.28	18.26	5.44
	33	10.66	2.96	12.57	3.67	14.36	4.43	14.76	4.79	15.68	5.18	16.74	5.30	17.72	5.45
	35	10.66	3.06	12.57	3.82	14.30	4.59	14.56	4.97	15.24	5.15	16.22	5.29	17.16	5.44
	37	10.66	3.29	12.57	4.09	14.10	4.89	14.30	5.21	14.71	5.57	15.64	5.42	16.56	5.57
	39	10.66	3.56	12.38	4.43	13.90	5.27	14.03	5.39	14.16	5.48	15.06	5.64	15.94	5.79
	42	10.66	3.91	12.05	4.85	13.40	5.49	13.77	5.58	13.52	5.67	14.35	5.82	15.21	6.00
44	10.52	4.19	11.91	5.16	13.10	5.61	13.57	5.70	13.05	5.76	13.87	5.95	14.72	6.10	
46	10.46	4.49	11.78	5.54	12.81	5.79	13.30	5.88	12.56	5.97	13.33	6.13	14.13	6.31	
60	10	9.13	1.78	10.78	2.19	12.82	2.63	13.50	2.86	14.34	3.09	16.00	3.57	17.69	4.04
	12	9.13	1.80	10.78	2.22	12.82	2.67	13.50	2.91	14.34	3.15	16.00	3.62	17.69	4.11
	14	9.13	1.83	10.78	2.26	12.82	2.72	13.50	2.96	14.34	3.21	16.00	3.70	17.69	4.20
	16	9.13	1.86	10.78	2.30	12.82	2.77	13.50	3.01	14.34	3.26	16.00	3.76	17.69	4.24
	18	9.13	1.89	10.78	2.34	12.82	2.83	13.50	3.07	14.34	3.34	16.00	3.82	17.69	4.34
	20	9.13	1.94	10.78	2.41	12.82	2.90	13.50	3.17	14.34	3.40	16.00	3.93	17.69	4.43
	21	9.13	1.98	10.78	2.45	12.82	2.96	13.50	3.22	14.34	3.48	16.00	4.00	17.69	4.53
	23	9.13	2.04	10.78	2.53	12.82	3.07	13.50	3.32	14.34	3.61	16.00	4.14	17.63	4.56
	25	9.13	2.14	10.78	2.66	12.82	3.20	13.33	3.48	14.16	3.79	15.80	4.32	17.14	4.62
	27	9.13	2.23	10.78	2.79	12.82	3.36	13.16	3.64	13.98	3.94	15.60	4.51	16.63	4.65
	29	9.13	2.34	10.78	2.90	12.82	3.50	12.99	3.79	13.80	4.12	15.25	4.55	16.15	4.68
	31	9.13	2.43	10.78	3.03	12.59	3.63	12.82	3.95	13.62	4.26	14.79	4.53	15.65	4.66
	33	9.13	2.53	10.78	3.15	12.31	3.79	12.65	4.10	13.44	4.44	14.34	4.54	15.19	4.67
	35	9.13	2.62	10.78	3.28	12.25	3.93	12.48	4.26	13.07	4.41	13.90	4.54	14.71	4.66
	37	9.13	2.82	10.78	3.50	12.08	4.19	12.25	4.47	12.61	4.77	13.40	4.65	14.19	4.77
	39	9.13	3.05	10.61	3.80	11.91	4.52	12.03	4.62	12.13	4.70	12.91	4.83	13.66	4.96
	42	9.13	3.35	10.32	4.16	11.48	4.70	11.80	4.78	11.59	4.86	12.30	4.99	13.04	5.14
44	9.02	3.59	10.21	4.42	11.23	4.81	11.63	4.89	11.19	4.94	11.89	5.10	12.62	5.23	
46	8.96	3.85	10.10	4.75	10.98	4.96	11.40	5.04	10.77	5.12	11.43	5.25	12.11	5.41	
50	10	7.61	1.49	8.98	1.82	10.68	2.19	11.25	2.38	11.95	2.58	13.34	2.97	14.74	3.37
	12	7.61	1.50	8.98	1.85	10.68	2.23	11.25	2.42	11.95	2.62	13.34	3.02	14.74	3.42
	14	7.61	1.53	8.98	1.88	10.68	2.27	11.25	2.47	11.95	2.67	13.34	3.08	14.74	3.50
	16	7.61	1.55	8.98	1.91	10.68	2.31	11.25	2.51	11.95	2.71	13.34	3.14	14.74	3.53
	18	7.61	1.58	8.98	1.95	10.68	2.35	11.25	2.55	11.95	2.78	13.34	3.19	14.74	3.62
	20	7.61	1.62	8.98	2.01	10.68	2.42	11.25	2.64	11.95	2.84	13.34	3.28	14.74	3.69
	21	7.61	1.65	8.98	2.05	10.68	2.47	11.25	2.68	11.95	2.90	13.34	3.34	14.74	3.77
	23	7.61	1.70	8.98	2.11	10.68	2.56	11.25	2.77	11.95	3.01	13.34	3.45	14.69	3.80
	25	7.61	1.78	8.98	2.22	10.68	2.67	11.11	2.90	11.80	3.16	13.17	3.60	14.28	3.85
	27	7.61	1.86	8.98	2.32	10.68	2.80	10.97	3.03	11.65	3.28	13.00	3.76	13.86	3.87
	29	7.61	1.95	8.98	2.42	10.68	2.91	10.83	3.16	11.50	3.43	12.71	3.79	13.46	3.90
	31	7.61	2.03	8.98	2.52	10.49	3.03	10.68	3.29	11.35	3.55	12.33	3.77	13.04	3.88
	33	7.61	2.11	8.98	2.62	10.26	3.16	10.54	3.42	11.20	3.70	11.95	3.79	12.66	3.89
	35	7.61	2.18	8.98	2.73	10.21	3.28	10.40	3.55	10.89	3.68	11.58	3.78	12.26	3.89
	37	7.61	2.35	8.98	2.92	10.07	3.49	10.21	3.72	10.51	3.98	11.17	3.87	11.83	3.98
	39	7.61	2.54	8.84	3.16	9.93	3.77	10.02	3.85	10.11	3.92	10.76	4.03	11.39	4.13
	42	7.61	2.79	8.60	3.46	9.57	3.92	9.83	3.98	9.66	4.05	10.25	4.16	10.86	4.29
44	7.52	2.99	8.51	3.68	9.36	4.01	9.69	4.07	9.32	4.12	9.91	4.25	10.51	4.36	
46	7.47	3.21	8.41	3.96	9.15	4.13	9.50	4.20	8.97	4.27	9.52	4.38	10.10	4.51	



## 4. Capacity table

4) \*\*100\*\*

TC : Total capacity, PI : Power input

Combination, %(Capacity index)	Outdoor temperature (°C, DB)	Indoor temperature (°C, WB)													
		14		16		18		19		20		22		24	
		TC	PI	TC	PI	TC	PI	TC	PI	TC	PI	TC	PI	TC	PI
		kW	kW	kW	kW	kW	kW	kW	kW	kW	kW	kW	kW	kW	kW
100	10	20.5	4.6	24.2	5.7	28.8	6.8	30.3	7.4	32.2	8.0	35.9	9.2	39.7	10.4
	12	20.5	4.7	24.2	5.7	28.8	6.9	30.3	7.5	32.2	8.1	35.9	9.4	39.7	10.6
	14	20.5	4.7	24.2	5.8	28.8	7.0	30.3	7.6	32.2	8.3	35.9	9.6	39.7	10.8
	16	20.5	4.8	24.2	5.9	28.8	7.2	30.3	7.8	32.2	8.4	35.9	9.7	39.7	10.9
	18	20.5	4.9	24.2	6.0	28.8	7.3	30.3	7.9	32.2	8.6	35.9	9.9	39.7	11.2
	20	20.5	5.0	24.2	6.2	28.8	7.5	30.3	8.2	32.2	8.8	35.9	10.2	39.7	11.4
	21	20.5	5.1	24.2	6.3	28.8	7.6	30.3	8.3	32.2	9.0	35.9	10.3	39.7	11.7
	23	20.5	5.3	24.2	6.5	28.8	7.9	30.3	8.6	32.2	9.3	35.9	10.7	39.6	11.8
	25	20.5	5.5	24.2	6.9	28.8	8.3	29.9	9.0	31.8	9.8	35.5	11.1	38.5	11.9
	27	20.5	5.8	24.2	7.2	28.8	8.7	29.5	9.4	31.4	10.2	35.0	11.6	37.3	12.0
	29	20.5	6.0	24.2	7.5	28.8	9.0	29.1	9.8	31.0	10.6	34.2	11.7	36.2	12.1
	31	20.5	6.3	24.2	7.8	28.3	9.4	28.8	10.2	30.6	11.0	33.2	11.7	35.1	12.0
	33	20.5	6.5	24.2	8.1	27.6	9.8	28.4	10.6	30.2	11.5	32.2	11.7	34.1	12.1
	35	20.5	6.8	24.2	8.5	27.5	10.2	28.0	11.0	29.3	11.4	31.2	11.7	33.0	12.0
	37	20.5	7.3	24.2	9.0	27.1	10.8	27.5	11.5	28.3	12.3	30.1	12.0	31.8	12.3
	39	20.5	7.9	23.8	9.8	26.7	11.7	27.0	11.9	27.2	12.1	29.0	12.5	30.7	12.8
	42	20.5	8.7	23.2	10.7	25.8	12.1	26.5	12.3	26.0	12.5	27.6	12.9	29.3	13.3
44	20.2	9.3	22.9	11.4	25.2	12.4	26.1	12.6	25.1	12.8	26.7	13.2	28.3	13.5	
46	20.1	9.9	22.7	12.3	24.6	12.8	25.6	13.0	24.2	13.2	25.6	13.6	27.2	14.0	
90	10	18.44	4.14	21.76	5.09	25.89	6.11	27.26	6.64	28.97	7.19	32.31	8.29	35.72	9.39
	12	18.44	4.19	21.76	5.16	25.89	6.22	27.26	6.76	28.97	7.31	32.31	8.42	35.72	9.54
	14	18.44	4.25	21.76	5.25	25.89	6.32	27.26	6.88	28.97	7.45	32.31	8.60	35.72	9.75
	16	18.44	4.32	21.76	5.33	25.89	6.44	27.26	7.00	28.97	7.57	32.31	8.74	35.72	9.85
	18	18.44	4.39	21.76	5.44	25.89	6.57	27.26	7.12	28.97	7.76	32.31	8.89	35.72	10.09
	20	18.44	4.51	21.76	5.59	25.89	6.75	27.26	7.36	28.97	7.91	32.31	9.14	35.72	10.30
	21	18.44	4.59	21.76	5.71	25.89	6.88	27.26	7.49	28.97	8.09	32.31	9.31	35.72	10.52
	23	18.44	4.74	21.76	5.89	25.89	7.14	27.26	7.73	28.97	8.38	32.31	9.63	35.60	10.61
	25	18.44	4.98	21.76	6.19	25.89	7.44	26.92	8.09	28.60	8.80	31.91	10.03	34.61	10.74
	27	18.44	5.19	21.76	6.48	25.89	7.82	26.57	8.45	28.24	9.15	31.50	10.48	33.57	10.80
	29	18.44	5.43	21.76	6.75	25.89	8.13	26.23	8.81	27.87	9.56	30.80	10.56	32.61	10.88
	31	18.44	5.65	21.76	7.03	25.43	8.44	25.89	9.18	27.51	9.91	29.87	10.52	31.61	10.83
	33	18.44	5.89	21.76	7.32	24.86	8.82	25.54	9.54	27.14	10.32	28.96	10.56	30.68	10.86
	35	18.44	6.09	21.76	7.62	24.74	9.14	25.20	9.90	26.38	10.25	28.07	10.54	29.70	10.84
	37	18.44	6.55	21.76	8.14	24.40	9.73	24.74	10.38	25.46	11.09	27.06	10.80	28.66	11.09
	39	18.44	7.08	21.42	8.82	24.05	10.51	24.28	10.75	24.50	10.93	26.07	11.23	27.59	11.53
	42	18.44	7.79	20.85	9.66	23.18	10.93	23.83	11.11	23.40	11.29	24.84	11.59	26.33	11.95
44	18.21	8.34	20.62	10.27	22.68	11.18	23.48	11.36	22.59	11.48	24.01	11.84	25.47	12.15	
46	18.10	8.95	20.39	11.04	22.18	11.53	23.02	11.71	21.74	11.89	23.08	12.20	24.46	12.57	
80	10	16.39	3.68	19.35	4.52	23.01	5.43	24.23	5.90	25.75	6.39	28.72	7.37	31.75	8.35
	12	16.39	3.73	19.35	4.59	23.01	5.52	24.23	6.01	25.75	6.50	28.72	7.49	31.75	8.48
	14	16.39	3.78	19.35	4.67	23.01	5.62	24.23	6.12	25.75	6.62	28.72	7.65	31.75	8.67
	16	16.39	3.84	19.35	4.74	23.01	5.72	24.23	6.22	25.75	6.73	28.72	7.77	31.75	8.75
	18	16.39	3.91	19.35	4.84	23.01	5.84	24.23	6.33	25.75	6.90	28.72	7.90	31.75	8.96
	20	16.39	4.01	19.35	4.97	23.01	6.00	24.23	6.55	25.75	7.03	28.72	8.12	31.75	9.15
	21	16.39	4.08	19.35	5.07	23.01	6.11	24.23	6.65	25.75	7.19	28.72	8.27	31.75	9.35
	23	16.39	4.21	19.35	5.23	23.01	6.34	24.23	6.87	25.75	7.45	28.72	8.56	31.64	9.43
	25	16.39	4.42	19.35	5.50	23.01	6.62	23.93	7.19	25.42	7.82	28.36	8.92	30.76	9.55
	27	16.39	4.61	19.35	5.76	23.01	6.95	23.62	7.51	25.10	8.13	28.00	9.32	29.84	9.60
	29	16.39	4.83	19.35	6.00	23.01	7.22	23.32	7.83	24.77	8.50	27.38	9.39	28.99	9.67
	31	16.39	5.02	19.35	6.25	22.60	7.50	23.01	8.16	24.45	8.81	26.56	9.35	28.10	9.62
	33	16.39	5.24	19.35	6.51	22.09	7.84	22.71	8.48	24.12	9.17	25.75	9.38	27.27	9.65
	35	16.39	5.42	19.35	6.77	21.99	8.12	22.40	8.80	23.45	9.11	24.95	9.37	26.40	9.63
	37	16.39	5.82	19.35	7.24	21.69	8.65	21.99	9.23	22.63	9.86	24.05	9.60	25.48	9.86
	39	16.39	6.30	19.04	7.84	21.38	9.34	21.59	9.55	21.78	9.71	23.18	9.98	24.52	10.24
	42	16.39	6.92	18.53	8.59	20.61	9.71	21.18	9.87	20.80	10.03	22.08	10.30	23.40	10.62
44	16.19	7.41	18.33	9.13	20.16	9.94	20.87	10.10	20.08	10.21	21.34	10.53	22.64	10.80	
46	16.09	7.96	18.12	9.81	19.71	10.25	20.47	10.41	19.32	10.57	20.51	10.85	21.74	11.17	

TC : Total capacity, PI : Power input

Combination, %(Capacity index)	Outdoor temperature (°C, DB)	Indoor temperature (°C, WB)													
		14		16		18		19		20		22		24	
		TC	PI	TC	PI	TC	PI	TC	PI	TC	PI	TC	PI	TC	PI
		kW	kW	kW	kW	kW	kW	kW	kW	kW	kW	kW	kW	kW	kW
70	10	14.34	3.22	16.93	3.96	20.13	4.75	21.20	5.16	22.53	5.59	25.13	6.45	27.78	7.30
	12	14.34	3.26	16.93	4.02	20.13	4.83	21.20	5.26	22.53	5.69	25.13	6.55	27.78	7.42
	14	14.34	3.31	16.93	4.09	20.13	4.92	21.20	5.35	22.53	5.79	25.13	6.69	27.78	7.59
	16	14.34	3.36	16.93	4.15	20.13	5.01	21.20	5.45	22.53	5.89	25.13	6.80	27.78	7.66
	18	14.34	3.42	16.93	4.23	20.13	5.11	21.20	5.54	22.53	6.03	25.13	6.91	27.78	7.84
	20	14.34	3.51	16.93	4.35	20.13	5.25	21.20	5.73	22.53	6.15	25.13	7.11	27.78	8.01
	21	14.34	3.57	16.93	4.44	20.13	5.35	21.20	5.82	22.53	6.29	25.13	7.24	27.78	8.18
	23	14.34	3.69	16.93	4.58	20.13	5.55	21.20	6.01	22.53	6.52	25.13	7.49	27.69	8.25
	25	14.34	3.87	16.93	4.81	20.13	5.79	20.94	6.29	22.24	6.85	24.82	7.80	26.92	8.36
	27	14.34	4.04	16.93	5.04	20.13	6.08	20.67	6.57	21.96	7.12	24.50	8.15	26.11	8.40
	29	14.34	4.22	16.93	5.25	20.13	6.32	20.40	6.85	21.68	7.44	23.95	8.22	25.37	8.46
	31	14.34	4.40	16.93	5.47	19.78	6.57	20.13	7.14	21.39	7.71	23.24	8.18	24.58	8.42
	33	14.34	4.58	16.93	5.69	19.33	6.86	19.87	7.42	21.11	8.02	22.53	8.21	23.86	8.44
	35	14.34	4.74	16.93	5.92	19.24	7.11	19.60	7.70	20.52	7.97	21.83	8.20	23.10	8.43
	37	14.34	5.09	16.93	6.33	18.98	7.57	19.24	8.08	19.80	8.63	21.05	8.40	22.29	8.63
	39	14.34	5.51	16.66	6.86	18.71	8.17	18.89	8.36	19.06	8.50	20.28	8.73	21.46	8.96
42	14.34	6.06	16.21	7.51	18.03	8.50	18.53	8.64	18.20	8.78	19.32	9.01	20.48	9.30	
44	14.17	6.49	16.04	7.99	17.64	8.70	18.26	8.84	17.57	8.93	18.67	9.21	19.81	9.45	
46	14.08	6.96	15.86	8.58	17.25	8.97	17.91	9.11	16.91	9.25	17.95	9.49	19.03	9.78	
60	10	12.29	2.76	14.51	3.39	17.26	4.07	18.17	4.43	19.31	4.79	21.54	5.53	23.81	6.26
	12	12.29	2.80	14.51	3.44	17.26	4.14	18.17	4.51	19.31	4.88	21.54	5.61	23.81	6.36
	14	12.29	2.84	14.51	3.50	17.26	4.21	18.17	4.59	19.31	4.97	21.54	5.73	23.81	6.50
	16	12.29	2.88	14.51	3.56	17.26	4.29	18.17	4.67	19.31	5.05	21.54	5.83	23.81	6.56
	18	12.29	2.93	14.51	3.63	17.26	4.38	18.17	4.75	19.31	5.17	21.54	5.92	23.81	6.72
	20	12.29	3.00	14.51	3.73	17.26	4.50	18.17	4.91	19.31	5.27	21.54	6.09	23.81	6.86
	23	12.29	3.16	14.51	3.92	17.26	4.76	18.17	5.15	19.31	5.59	21.54	6.42	23.73	7.07
	25	12.29	3.32	14.51	4.12	17.26	4.96	17.95	5.39	19.07	5.87	21.27	6.69	23.07	7.16
	27	12.29	3.46	14.51	4.32	17.26	5.21	17.72	5.63	18.82	6.10	21.00	6.99	22.38	7.20
	29	12.29	3.62	14.51	4.50	17.26	5.42	17.49	5.88	18.58	6.38	20.53	7.04	21.74	7.25
	31	12.29	3.77	14.51	4.69	16.95	5.63	17.26	6.12	18.34	6.61	19.92	7.01	21.07	7.22
	33	12.29	3.93	14.51	4.88	16.57	5.88	17.03	6.36	18.09	6.88	19.31	7.04	20.45	7.24
	35	12.29	4.06	14.51	5.08	16.49	6.09	16.80	6.60	17.59	6.83	18.71	7.03	19.80	7.22
	37	12.29	4.37	14.51	5.43	16.27	6.49	16.49	6.92	16.97	7.39	18.04	7.20	19.11	7.39
	39	12.29	4.72	14.28	5.88	16.04	7.00	16.19	7.16	16.33	7.28	17.38	7.48	18.39	7.68
	42	12.29	5.19	13.90	6.44	15.46	7.28	15.88	7.40	15.60	7.53	16.56	7.73	17.55	7.97
44	12.14	5.56	13.75	6.85	15.12	7.45	15.65	7.57	15.06	7.65	16.00	7.90	16.98	8.10	
46	12.07	5.97	13.59	7.36	14.78	7.68	15.35	7.81	14.49	7.93	15.38	8.13	16.31	8.38	
50	10	10.25	2.30	12.09	2.83	14.38	3.40	15.15	3.69	16.09	3.99	17.95	4.61	19.84	5.22
	12	10.25	2.33	12.09	2.87	14.38	3.45	15.15	3.76	16.09	4.06	17.95	4.68	19.84	5.30
	14	10.25	2.36	12.09	2.92	14.38	3.51	15.15	3.82	16.09	4.14	17.95	4.78	19.84	5.42
	16	10.25	2.40	12.09	2.96	14.38	3.58	15.15	3.89	16.09	4.20	17.95	4.86	19.84	5.47
	18	10.25	2.44	12.09	3.02	14.38	3.65	15.15	3.96	16.09	4.31	17.95	4.94	19.84	5.60
	20	10.25	2.50	12.09	3.11	14.38	3.75	15.15	4.09	16.09	4.39	17.95	5.08	19.84	5.72
	21	10.25	2.55	12.09	3.17	14.38	3.82	15.15	4.16	16.09	4.50	17.95	5.17	19.84	5.84
	23	10.25	2.63	12.09	3.27	14.38	3.97	15.15	4.29	16.09	4.66	17.95	5.35	19.78	5.89
	25	10.25	2.76	12.09	3.44	14.38	4.13	14.95	4.49	15.89	4.89	17.73	5.57	19.23	5.97
	27	10.25	2.88	12.09	3.60	14.38	4.34	14.76	4.70	15.69	5.08	17.50	5.82	18.65	6.00
	29	10.25	3.02	12.09	3.75	14.38	4.51	14.57	4.90	15.48	5.31	17.11	5.87	18.12	6.04
	31	10.25	3.14	12.09	3.91	14.13	4.69	14.38	5.10	15.28	5.51	16.60	5.85	17.56	6.02
	33	10.25	3.27	12.09	4.07	13.81	4.90	14.19	5.30	15.08	5.73	16.09	5.87	17.04	6.03
	35	10.25	3.38	12.09	4.23	13.75	5.08	14.00	5.50	14.66	5.70	15.59	5.86	16.50	6.02
	37	10.25	3.64	12.09	4.52	13.55	5.41	13.75	5.77	14.14	6.16	15.03	6.00	15.92	6.16
	39	10.25	3.94	11.90	4.90	13.36	5.84	13.49	5.97	13.61	6.07	14.48	6.24	15.33	6.40
42	10.25	4.33	11.58	5.37	12.88	6.07	13.24	6.17	13.00	6.27	13.80	6.44	14.63	6.64	
44	10.12	4.63	11.45	5.71	12.60	6.21	13.05	6.31	12.55	6.38	13.34	6.58	14.15	6.75	
46	10.05	4.97	11.33	6.13	12.32	6.40	12.79	6.51	12.08	6.61	12.82	6.78	13.59	6.98	



## 4. Capacity table

## (2) Heating

1) \*\*050\*\*

TC : Total capacity, PI : Power input

Combination, %(Capacity index)	Outdoor temperature		Indoor temperature (°C, DB)											
			16		18		20		21		22		24	
	°C, DB	°C, WB	TC	PI	TC	PI	TC	PI	TC	PI	TC	PI	TC	PI
100	-15	-14	10.6	4.2	10.4	4.5	10.2	4.6	10.1	4.7	9.9	4.9	9.9	4.9
	-12	-13	11.8	4.4	11.7	4.6	11.6	4.7	11.4	4.9	11.2	5.1	11.2	5.1
	-10	-11	13.3	4.5	13.0	4.7	12.6	4.8	12.5	5.0	12.3	5.1	12.3	5.1
	-7	-8	14.4	4.8	14.1	5.0	13.6	5.1	13.3	5.2	13.0	5.3	13.0	5.3
	-5	-6	15.5	5.1	14.9	5.2	14.4	5.3	14.1	5.4	13.8	5.5	13.8	5.5
	-3	-4	16.3	5.4	15.7	5.5	15.1	5.6	14.7	5.7	13.8	5.7	13.8	5.7
	0	-1	17.0	5.6	16.3	5.6	16.0	5.7	14.7	5.8	13.8	5.6	13.8	5.6
	3	2.2	17.3	5.3	17.0	5.4	16.0	5.5	14.7	5.5	13.8	5.2	13.8	5.2
	5	4.1	17.9	5.0	17.3	5.1	16.0	5.2	14.7	5.1	13.8	4.7	13.8	4.7
	7	6	18.4	4.8	17.3	4.9	16.0	5.0	14.7	4.6	13.8	4.3	13.8	4.3
	9	7.9	18.7	4.8	17.3	4.9	16.0	4.8	14.7	4.5	13.8	4.1	13.8	4.1
	11	9.8	18.7	4.9	17.3	5.0	16.0	4.7	14.7	4.4	13.8	4.0	13.8	4.0
	13	12	18.7	5.0	17.3	4.9	16.0	4.6	14.7	4.3	13.8	3.9	13.8	3.9
	15	14	18.7	5.0	17.3	4.7	16.0	4.4	14.7	4.1	13.8	3.8	13.8	3.8
	90	-15	-14	10.2	4.1	10.1	4.4	9.9	4.4	9.8	4.6	9.6	4.8	9.6
-12		-13	11.5	4.2	11.3	4.4	11.2	4.5	11.0	4.8	10.9	4.9	10.9	4.9
-10		-11	12.6	4.3	12.3	4.5	12.0	4.6	11.9	4.8	11.7	4.9	11.7	4.9
-7		-8	13.7	4.6	13.4	4.8	12.9	4.8	12.6	5.0	12.3	5.0	12.3	5.0
-5		-6	14.3	4.7	13.7	4.8	13.2	4.9	13.0	5.0	12.7	5.0	12.7	5.0
-3		-4	15.0	5.0	14.4	5.1	13.9	5.2	13.5	5.3	12.7	5.2	12.7	5.2
0		-1	15.6	5.1	15.0	5.2	14.7	5.3	13.5	5.4	12.7	5.1	12.7	5.1
3		2.2	15.6	4.7	15.3	4.8	14.4	4.9	13.2	5.0	12.4	4.7	12.4	4.7
5		4.1	16.1	4.5	15.6	4.6	14.4	4.7	13.2	4.6	12.4	4.3	12.4	4.3
7		6	16.6	4.3	15.6	4.4	14.4	4.5	13.2	4.2	12.4	3.9	12.4	3.9
9		7.9	16.8	4.3	15.6	4.4	14.4	4.3	13.2	4.0	12.4	3.7	12.4	3.7
11		9.8	16.8	4.4	15.6	4.5	14.4	4.2	13.2	3.9	12.4	3.6	12.4	3.6
13		12	16.8	4.5	15.6	4.4	14.4	4.1	13.2	3.8	12.4	3.5	12.4	3.5
15		14	16.8	4.5	15.6	4.3	14.4	4.0	13.2	3.7	12.4	3.4	12.4	3.4
80		-15	-14	10.0	4.0	9.9	4.3	9.7	4.4	9.6	4.5	9.4	4.7	9.4
	-12	-13	10.9	4.0	10.7	4.2	10.6	4.3	10.5	4.5	10.3	4.6	10.3	4.6
	-10	-11	12.2	4.2	11.9	4.4	11.6	4.5	11.5	4.6	11.3	4.7	11.3	4.7
	-7	-8	13.2	4.5	13.0	4.6	12.5	4.6	12.2	4.8	11.9	4.9	11.9	4.9
	-5	-6	14.3	4.7	13.7	4.8	13.2	4.9	13.0	5.0	12.7	5.0	12.7	5.0
	-3	-4	15.0	5.0	14.4	5.1	13.9	5.2	13.5	5.3	12.7	5.2	12.7	5.2
	0	-1	15.3	9.0	15.0	5.2	14.7	5.3	13.5	5.4	12.7	5.1	12.7	5.1
	3	2.2	13.8	4.2	13.6	4.3	12.8	4.4	11.8	4.4	11.0	4.1	11.0	4.1
	5	4.1	14.3	4.0	13.8	4.1	12.8	4.2	11.8	4.1	11.0	3.8	11.0	3.8
	7	6	14.7	3.8	13.8	3.9	12.8	4.0	11.8	3.7	11.0	3.4	11.0	3.4
	9	7.9	15.0	3.9	13.8	3.9	12.8	3.8	11.8	3.6	11.0	3.3	11.0	3.3
	11	9.8	15.0	3.9	13.8	4.0	12.8	3.8	11.8	3.5	11.0	3.2	11.0	3.2
	13	12	15.0	4.0	13.8	3.9	12.8	3.7	11.8	3.4	11.0	3.1	11.0	3.1
	15	14	15.0	4.0	13.8	3.8	12.8	3.5	11.8	3.3	11.0	3.0	11.0	3.0

2) \*\*060\*\*

TC : Total capacity, PI : Power input

Combination, %(Capacity index)	Outdoor temperature		Indoor temperature (°C, DB)											
			16		18		20		21		22		24	
	°C, DB	°C, WB	TC	PI	TC	PI	TC	PI	TC	PI	TC	PI	TC	PI
100	-15	-14	11.9	6.0	11.7	6.4	11.5	6.5	11.3	6.7	11.2	6.9	11.2	6.9
	-12	-13	13.3	6.2	13.1	6.5	13.0	6.6	12.8	6.9	12.6	7.1	12.6	7.1
	-10	-11	14.9	6.4	14.6	6.7	14.2	6.9	14.0	7.1	13.9	7.2	13.9	7.2
	-7	-8	16.2	6.9	15.8	7.1	15.3	7.1	14.9	7.4	14.6	7.5	14.6	7.5
	-5	-6	17.5	7.2	16.7	7.4	16.2	7.5	15.8	7.7	15.5	7.8	15.5	7.8
	-3	-4	18.4	7.7	17.6	7.8	17.0	8.0	16.6	8.1	15.5	8.0	15.5	8.0
	0	-1	19.1	7.9	18.4	8.0	18.0	8.1	16.6	8.3	15.5	7.9	15.5	7.9
	3	2.2	19.4	7.5	19.1	7.6	18.0	7.7	16.6	7.8	15.5	7.3	15.5	7.3
	5	4.1	20.2	7.1	19.4	7.2	18.0	7.4	16.6	7.2	15.5	6.7	15.5	6.7
	7	6	20.7	6.8	19.4	6.9	18.0	7.0	16.6	6.6	15.5	6.1	15.5	6.1
	9	7.9	21.1	6.8	19.4	6.9	18.0	6.8	16.6	6.3	15.5	5.9	15.5	5.9
	11	9.8	21.1	6.9	19.4	7.1	18.0	6.6	16.6	6.2	15.5	5.7	15.5	5.7
	13	12	21.1	7.1	19.4	6.9	18.0	6.5	16.6	6.0	15.5	5.6	15.5	5.6
	15	14	21.1	7.1	19.4	6.7	18.0	6.3	16.6	5.8	15.5	5.3	15.5	5.3
	90	-15	-14	11.5	5.8	11.3	6.2	11.1	6.3	11.0	6.5	10.8	6.7	10.8
-12		-13	12.9	6.0	12.7	6.3	12.6	6.4	12.4	6.7	12.2	6.9	12.2	6.9
-10		-11	14.2	6.1	13.9	6.4	13.5	6.5	13.3	6.7	13.2	6.9	13.2	6.9
-7		-8	15.4	6.5	15.0	6.7	14.6	6.8	14.2	7.0	13.9	7.1	13.9	7.1
-5		-6	16.1	6.7	15.4	6.8	14.9	6.9	14.6	7.0	14.2	7.1	14.2	7.1
-3		-4	16.9	7.1	16.2	7.2	15.7	7.3	15.2	7.5	14.2	7.4	14.2	7.4
0		-1	17.6	7.2	16.9	7.3	16.6	7.5	15.2	7.6	14.2	7.3	14.2	7.3
3		2.2	17.5	6.7	17.2	6.8	16.2	7.0	14.9	7.1	13.9	6.6	13.9	6.6
5		4.1	18.1	6.4	17.5	6.5	16.2	6.6	14.9	6.5	13.9	6.0	13.9	6.0
7		6	18.6	6.1	17.5	6.2	16.2	6.3	14.9	5.9	13.9	5.5	13.9	5.5
9		7.9	19.0	6.1	17.5	6.2	16.2	6.1	14.9	5.7	13.9	5.3	13.9	5.3
11		9.8	19.0	6.2	17.5	6.4	16.2	6.0	14.9	5.6	13.9	5.1	13.9	5.1
13		12	19.0	6.4	17.5	6.2	16.2	5.8	14.9	5.4	13.9	5.0	13.9	5.0
15		14	19.0	6.4	17.5	6.0	16.2	5.6	14.9	5.2	13.9	4.8	13.9	4.8
80		-15	-14	11.3	5.7	11.1	6.1	10.9	6.2	10.8	6.4	10.6	6.6	10.6
	-12	-13	12.3	5.7	12.1	6.0	12.0	6.1	11.8	6.4	11.6	6.6	11.6	6.6
	-10	-11	13.7	5.9	13.4	6.2	13.1	6.3	12.9	6.5	12.8	6.6	12.8	6.6
	-7	-8	14.9	6.3	14.6	6.5	14.1	6.6	13.7	6.8	13.4	6.9	13.4	6.9
	-5	-6	16.1	6.7	15.4	6.8	14.9	6.9	14.6	7.0	14.2	7.1	14.2	7.1
	-3	-4	16.9	7.1	16.2	7.2	15.7	7.3	15.2	7.5	14.2	7.4	14.2	7.4
	0	-1	17.2	9.0	16.9	7.3	16.6	7.5	15.2	7.6	14.2	7.3	14.2	7.3
	3	2.2	15.6	6.0	15.3	6.1	14.4	6.2	13.2	6.3	12.4	5.9	12.4	5.9
	5	4.1	16.1	5.7	15.6	5.8	14.4	5.9	13.2	5.7	12.4	5.3	12.4	5.3
	7	6	16.6	5.4	15.6	5.5	14.4	5.6	13.2	5.3	12.4	4.9	12.4	4.9
	9	7.9	16.8	5.4	15.6	5.5	14.4	5.4	13.2	5.1	12.4	4.7	12.4	4.7
	11	9.8	16.8	5.6	15.6	5.7	14.4	5.3	13.2	5.0	12.4	4.6	12.4	4.6
	13	12	16.8	5.7	15.6	5.5	14.4	5.2	13.2	4.8	12.4	4.4	12.4	4.4
	15	14	16.8	5.7	15.6	5.4	14.4	5.0	13.2	4.6	12.4	4.2	12.4	4.2



# 4. Capacity table

3) \*\*100\*\*

TC : Total capacity, PI : Power input

Combination, %(Capacity index)	Outdoor temperature		Indoor temperature (°C, DB)											
			16		18		20		21		22		24	
	°C, DB	°C, WB	TC	PI	TC	PI	TC	PI	TC	PI	TC	PI	TC	PI
100	-15	-14	20.8	9.0	20.5	9.6	20.1	9.7	19.8	10.1	19.5	10.4	19.5	10.4
	-12	-13	23.3	9.3	23.0	9.7	22.8	9.9	22.4	10.4	22.1	10.7	22.1	10.7
	-10	-11	26.1	9.6	25.5	10.1	24.9	10.3	24.6	10.6	24.3	10.8	24.3	10.8
	-7	-8	28.4	10.3	27.7	10.6	26.8	10.7	26.1	11.1	25.5	11.3	25.5	11.3
	-5	-6	30.6	10.9	29.3	11.1	28.3	11.3	27.7	11.5	27.1	11.6	27.1	11.6
	-3	-4	32.1	11.5	30.9	11.7	29.8	11.9	29.0	12.2	27.1	12.0	27.1	12.0
	0	-1	33.4	11.8	32.1	11.9	31.5	12.2	29.0	12.4	27.1	11.8	27.1	11.8
	3	2.2	34.0	11.2	33.4	11.4	31.5	11.6	29.0	11.8	27.1	11.0	27.1	11.0
	5	4.1	35.3	10.7	34.0	10.9	31.5	11.1	29.0	10.8	27.1	10.0	27.1	10.0
	7	6	36.2	10.1	34.0	10.3	31.5	10.5	29.0	9.9	27.1	9.1	27.1	9.1
	9	7.9	36.9	10.2	34.0	10.4	31.5	10.2	29.0	9.5	27.1	8.8	27.1	8.8
	11	9.8	36.9	10.4	34.0	10.6	31.5	9.9	29.0	9.3	27.1	8.5	27.1	8.5
	13	12	36.9	10.6	34.0	10.4	31.5	9.7	29.0	9.1	27.1	8.3	27.1	8.3
	15	14	36.9	10.7	34.0	10.1	31.5	9.4	29.0	8.7	27.1	8.0	27.1	8.0
	90	-15	-14	20.2	8.7	19.9	9.3	19.5	9.4	19.2	9.8	18.9	10.1	18.9
-12		-13	22.6	9.0	22.3	9.4	22.1	9.6	21.7	10.1	21.4	10.4	21.4	10.4
-10		-11	24.8	9.1	24.2	9.6	23.6	9.8	23.3	10.1	23.0	10.3	23.0	10.3
-7		-8	26.9	9.8	26.3	10.1	25.5	10.2	24.8	10.5	24.2	10.7	24.2	10.7
-5		-6	28.1	10.0	27.0	10.2	26.0	10.4	25.5	10.6	24.9	10.7	24.9	10.7
-3		-4	29.6	10.6	28.4	10.8	27.4	11.0	26.7	11.2	24.9	11.1	24.9	11.1
0		-1	30.7	10.8	29.6	11.0	29.0	11.2	26.7	11.4	24.9	10.9	24.9	10.9
3		2.2	30.6	10.1	30.1	10.3	28.4	10.4	26.1	10.6	24.4	9.9	24.4	9.9
5		4.1	31.8	9.6	30.6	9.8	28.4	9.9	26.1	9.7	24.4	9.0	24.4	9.0
7		6	32.6	9.1	30.6	9.3	28.4	9.5	26.1	8.9	24.4	8.2	24.4	8.2
9		7.9	33.2	9.2	30.6	9.4	28.4	9.2	26.1	8.5	24.4	7.9	24.4	7.9
11		9.8	33.2	9.4	30.6	9.5	28.4	9.0	26.1	8.4	24.4	7.7	24.4	7.7
13		12	33.2	9.6	30.6	9.4	28.4	8.8	26.1	8.2	24.4	7.5	24.4	7.5
15		14	33.2	9.6	30.6	9.1	28.4	8.5	26.1	7.8	24.4	7.2	24.4	7.2
80		-15	-14	19.8	8.5	19.5	9.1	19.1	9.2	18.9	9.6	18.6	9.9	18.6
	-12	-13	21.4	8.5	21.2	8.9	20.9	9.2	20.6	9.6	20.3	9.9	20.3	9.9
	-10	-11	24.1	8.8	23.5	9.3	22.9	9.5	22.6	9.8	22.3	10.0	22.3	10.0
	-7	-8	26.1	9.5	25.5	9.8	24.7	9.9	24.1	10.2	23.5	10.4	23.5	10.4
	-5	-6	28.1	10.0	27.0	10.2	26.0	10.4	25.5	10.6	24.9	10.7	24.9	10.7
	-3	-4	29.6	10.6	28.4	10.8	27.4	11.0	26.7	11.2	24.9	11.1	24.9	11.1
	0	-1	30.1	9.0	29.6	11.0	29.0	11.2	26.7	11.4	24.9	10.9	24.9	10.9
	3	2.2	27.2	9.0	26.7	9.1	25.2	9.3	23.2	9.4	21.7	8.8	21.7	8.8
	5	4.1	28.2	8.5	27.2	8.7	25.2	8.8	23.2	8.6	21.7	8.0	21.7	8.0
	7	6	29.0	8.1	27.2	8.3	25.2	8.4	23.2	7.9	21.7	7.3	21.7	7.3
	9	7.9	29.5	8.2	27.2	8.3	25.2	8.1	23.2	7.6	21.7	7.0	21.7	7.0
	11	9.8	29.5	8.3	27.2	8.5	25.2	8.0	23.2	7.4	21.7	6.8	21.7	6.8
	13	12	29.5	8.5	27.2	8.3	25.2	7.8	23.2	7.2	21.7	6.7	21.7	6.7
	15	14	29.5	8.5	27.2	8.0	25.2	7.5	23.2	6.9	21.7	6.4	21.7	6.4

# 5. Dimension

## 5-1. Upward (2-FAN)

Unit : mm

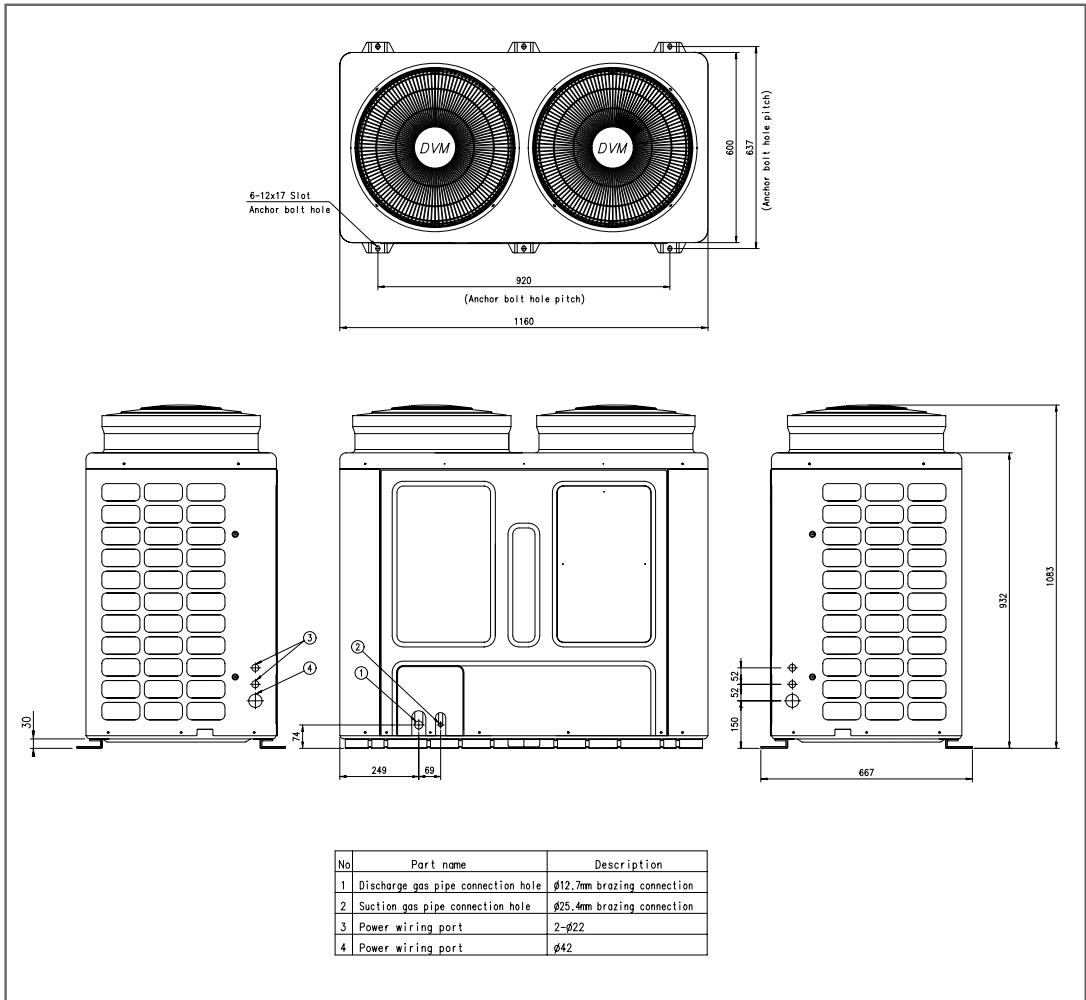



# 5. Dimension

## 5-2. Onward

Unit : mm

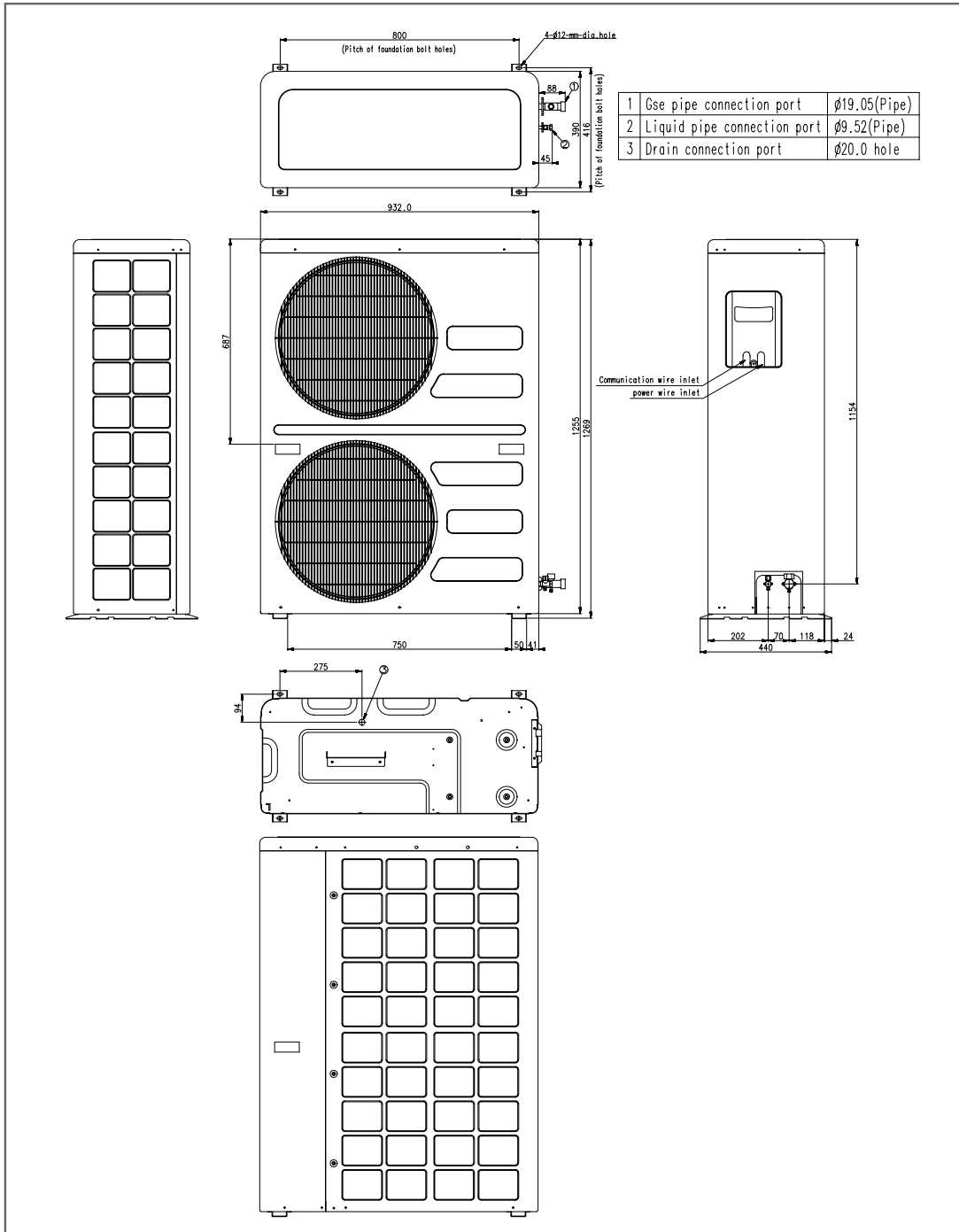



### 5-3. Upward (1-FAN)

Unit : mm

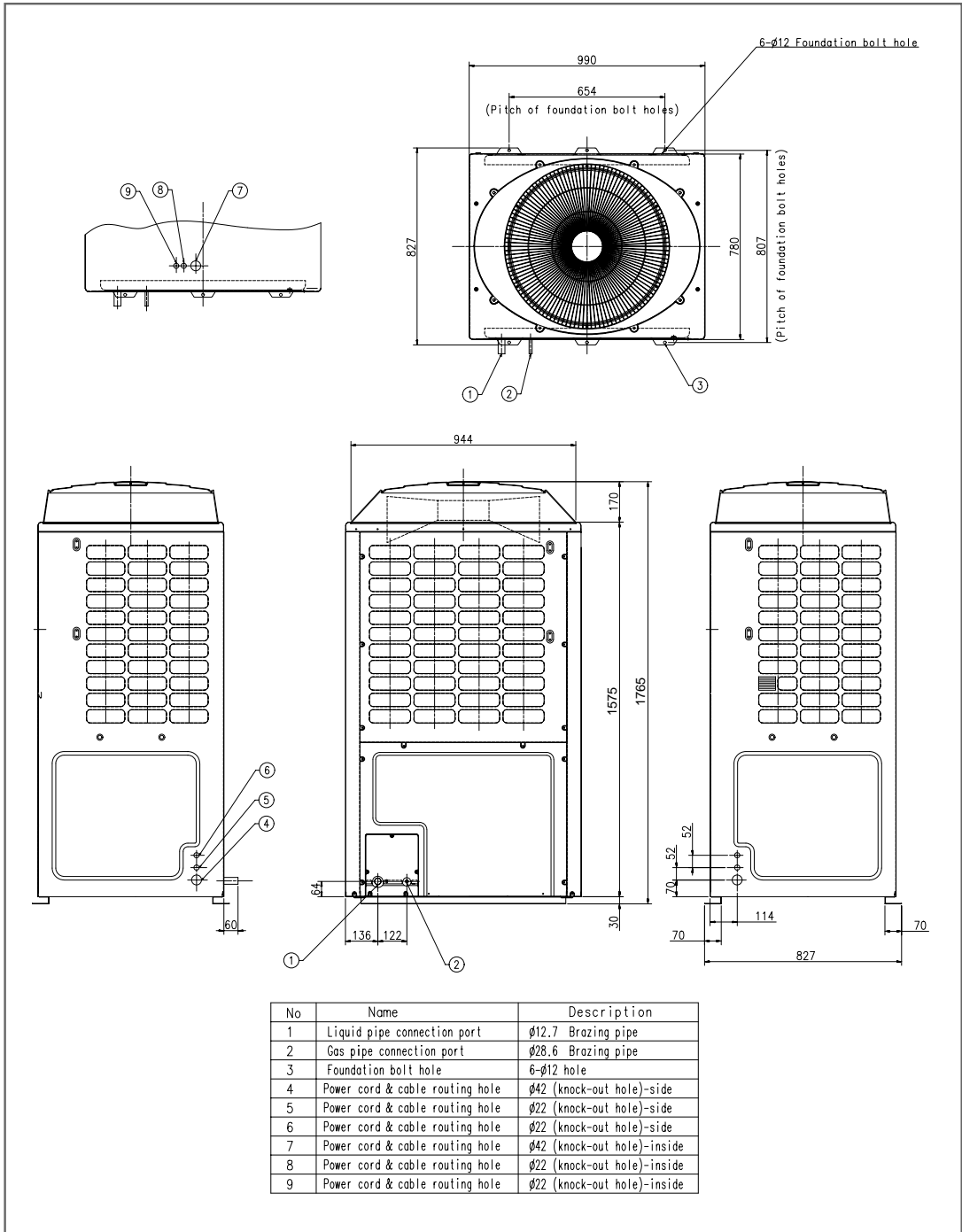



## 5. Dimension

### 5-4. Upward(Super cooler)

Unit : mm

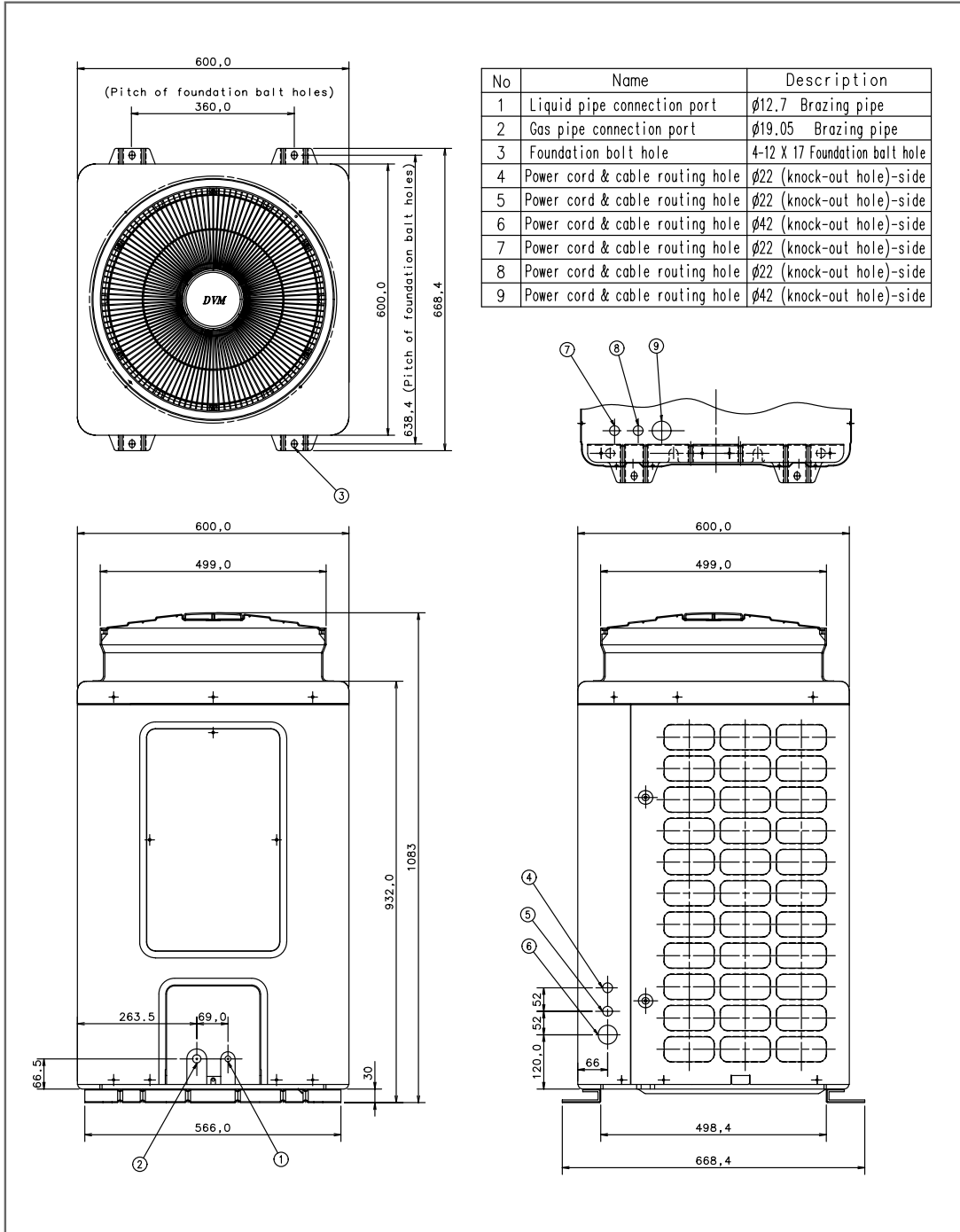

# 6. Refrigerant system diagram

## 6-1. Cooling only

(1) **\*\*050/060/072\*\***

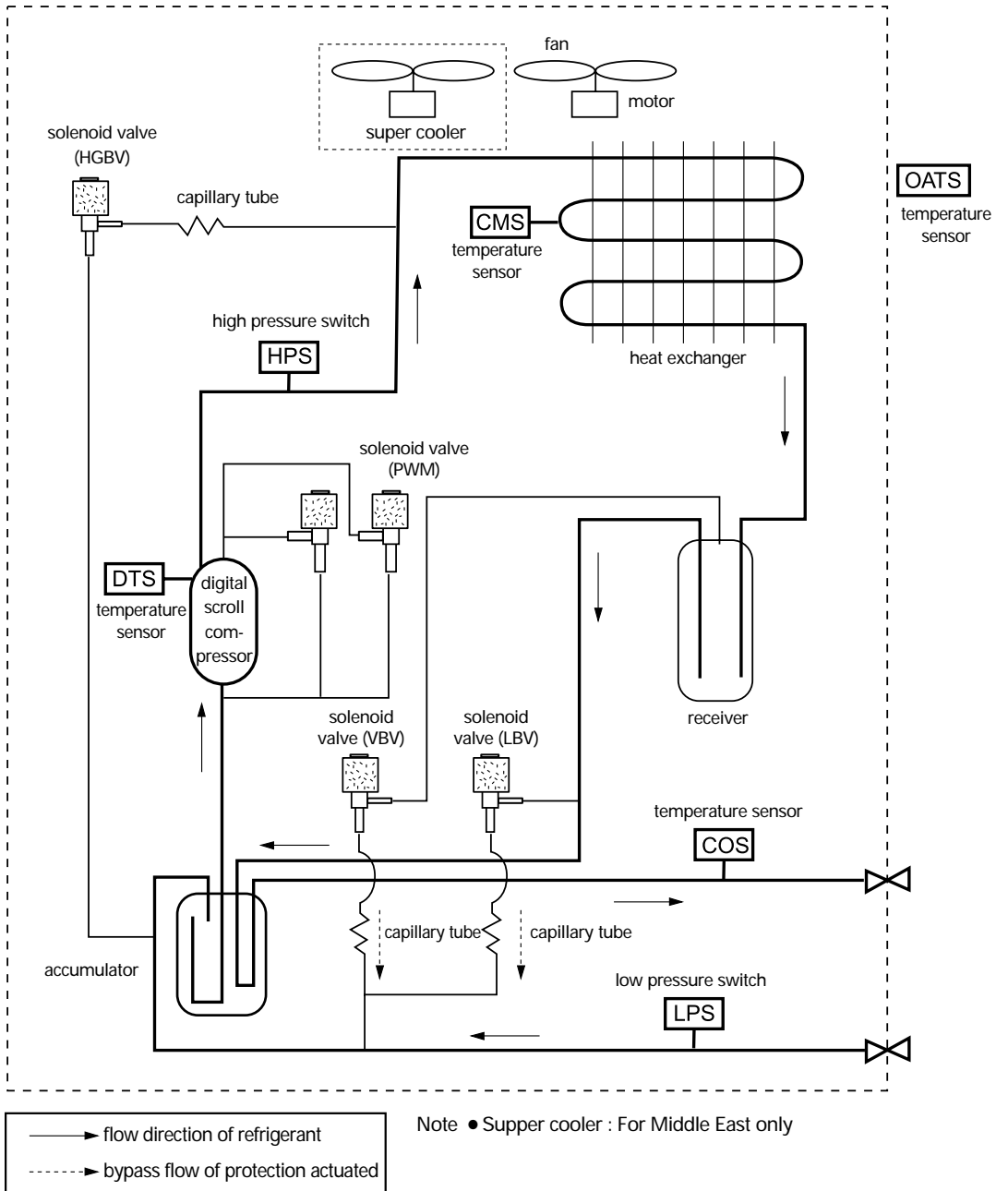

## 6. Refrigerant system diagram

(2) \*\*080/100\*\*

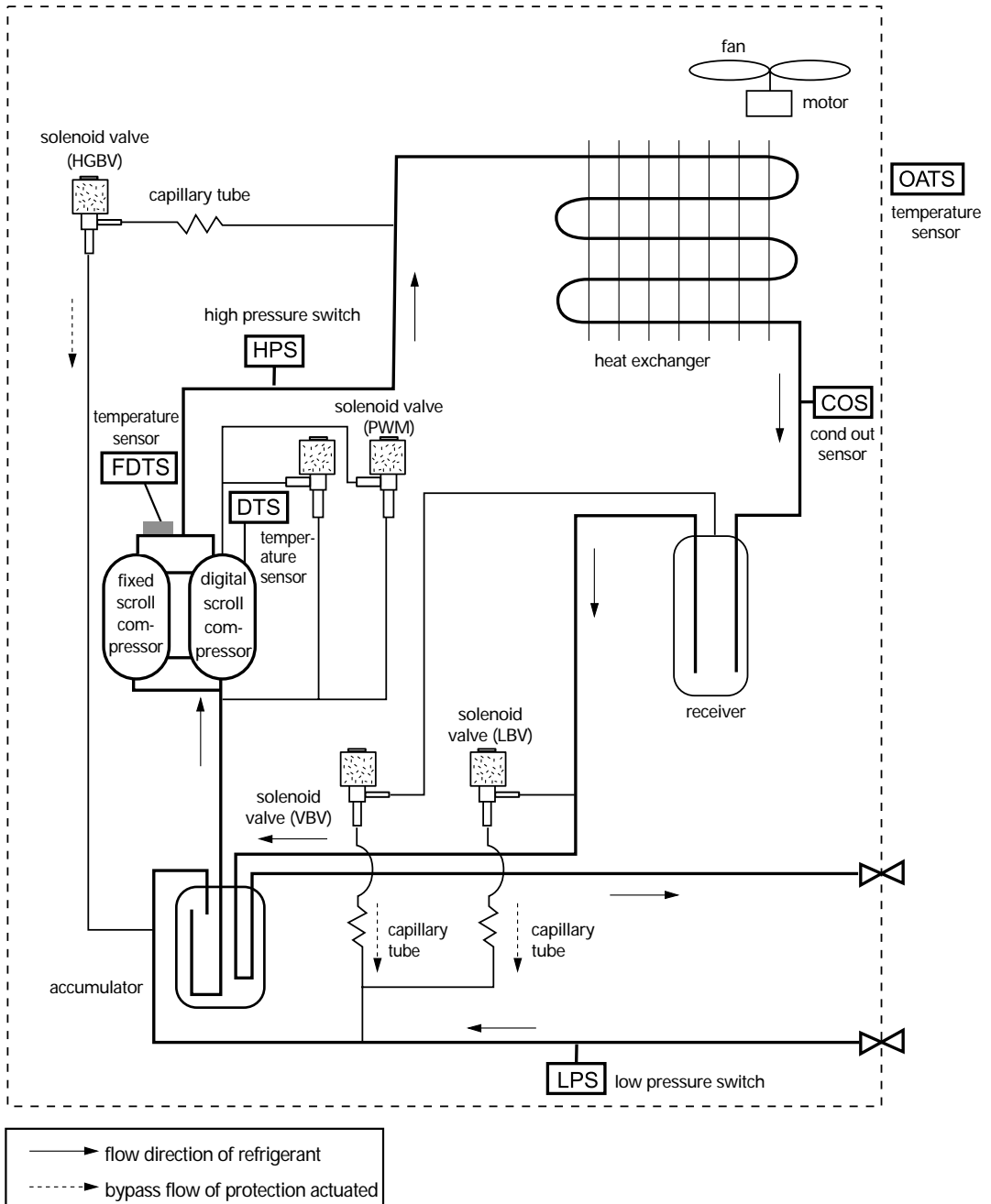

### **(3) Main parts status**

- 1) **Digital scroll compressor**  
The variable capacity type compressor to control the capacity up to 10 ~ 100% with 19 steps.
- 2) **Accumulator**  
To prevent the incoming of the liquid refrigerant to the compressor (prevention of liquid back).
- 3) **Receiver**  
To reduce the noise by flowing the high pressure liquid refrigerant to the high pressure pipe and to control the amount of refrigerant during the individual operation of indoor unit.
- 4) **Solenoid valve (PWM)**  
It is installed at the top of digital scroll compressor and at the low pressure pipe, which is used for operating the digital scroll compressor.  
When the valve is open, the digital scroll compressor keeps the state of unloading.
- 5) **Solenoid valve (HGBV)**  
When the low pressure gets lower, the valve is open by the low pressure safety device.  
The valve is open in order to reduce the load at the start of compressor and when the system stops and then keep the balance of low pressure.
- 6) **Solenoid valve (LBV)**  
When the compressor is overheated, it actuates to lower the temperature of compressor for stable operation.
- 7) **Solenoid valve (VBV)**  
The valve is open in order to reduce the load at the start of compressor and when the system stops and then keeps the balance of low pressure.
- 8) **High pressure switch**  
To stop the system for the system protection when the high pressure exceeds the set value.
- 9) **Low pressure switch**  
To stop the system for the system protection when the low pressure falls below the set value.
- 10) **Temperature sensor (DTS, Discharge Temperature Sensor)**  
It is the means to measure the refrigerant temperature of compressor outlet which is used as the data for control of compressor.
- 11) **Temperature sensor (CMS, Condenser Mid Sensor)**  
It is the detection means to do the optimum control of outdoor fan, which is used as the data for each protection or initial startup.
- 12) **Temperature sensor (COS, Condenser Out Sensor)**  
It is used as the detection for calculation of over-cooling at the condenser outlet which is referred for the adjustment of refrigerant during refrigerant charging.
- 13) **Temperature sensor (OATS, Outdoor Air Temperature Sensor)**  
To measure the outdoor temperature which is used for the determination of start method.
- 14) **Fixed scroll compressor**  
The fixed capacity type compressor.
- 15) **Temperature sensor (FDTS, Fixed Discharge Temperature Sensor)**  
It is the means to measure the refrigerant temperature of compressor outlet which is used as the data for control of fixed compressor.

# 6. Refrigerant system diagram

## 6-2. Heat pump

(1) \*\*050/060\*\*

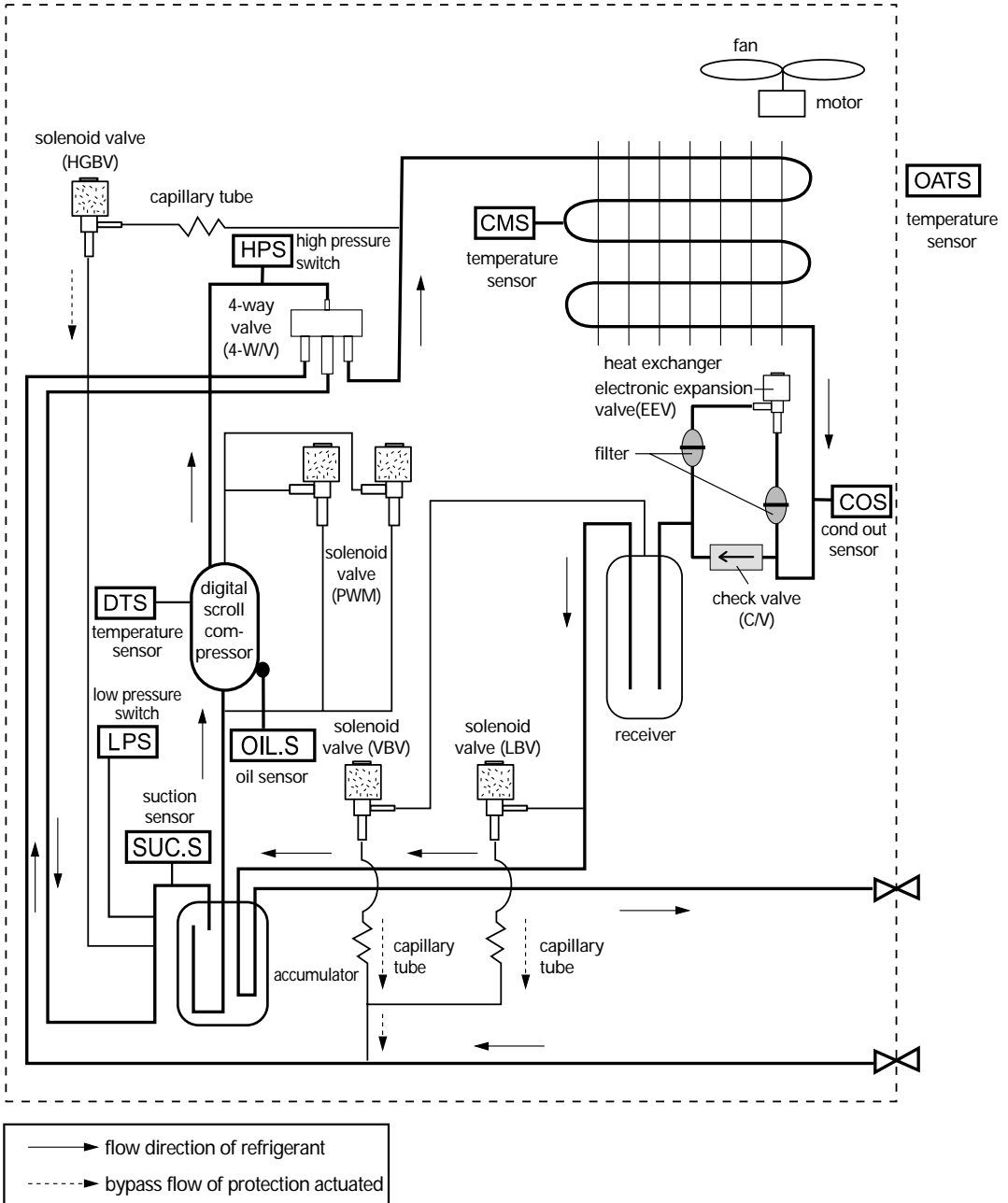

(2) \*\*080/100\*\*

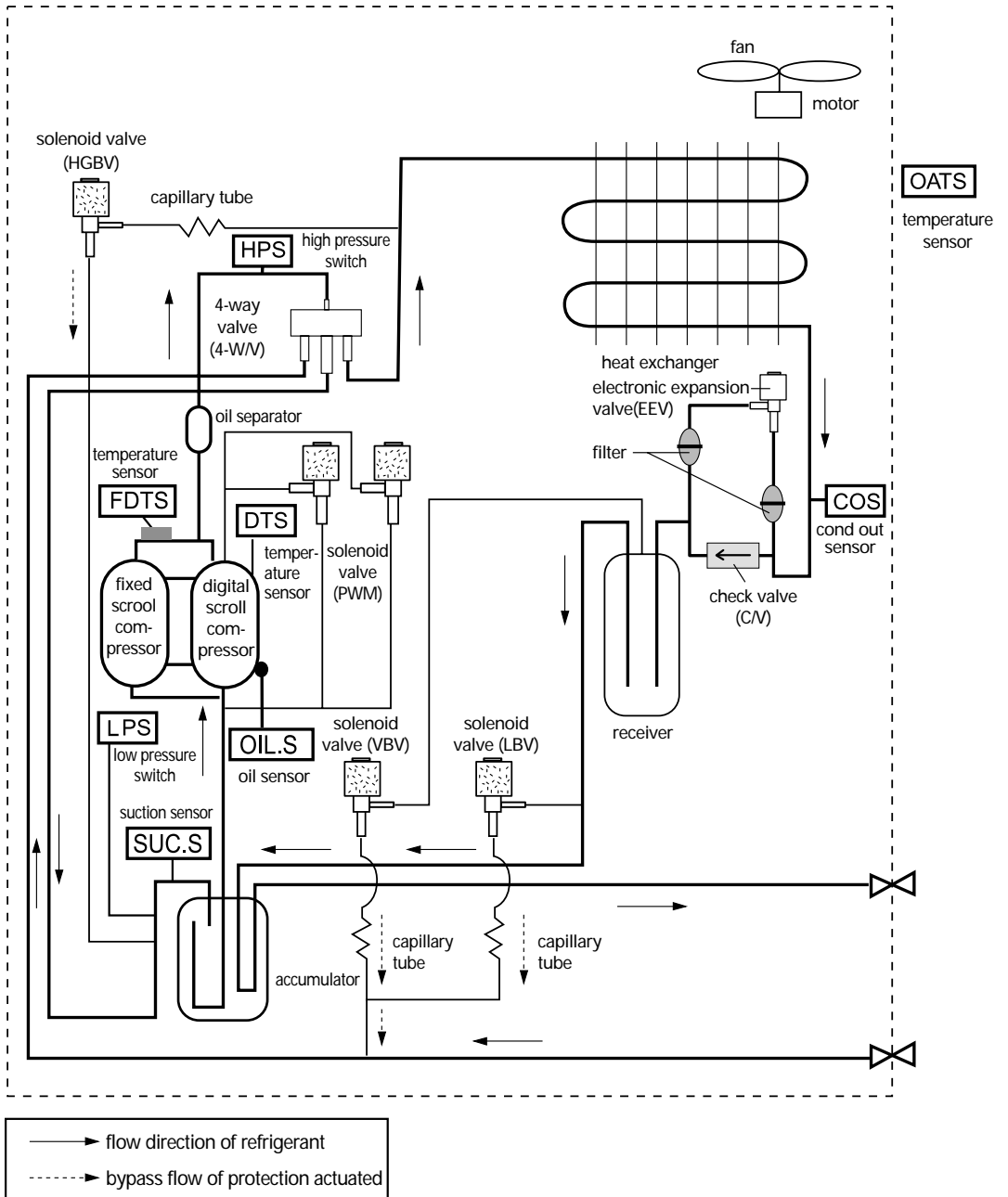



## 6. Refrigerant system diagram

### (3) Main parts status

1) Digital scroll compressor

The variable capacity type compressor to control the capacity up to 10 ~ 100% with 19 steps

2) Accumulator

To prevent the incoming of the liquid refrigerant to the compressor (prevention of liquid back).

3) Receiver

To reduce the noise by flowing the high pressure liquid refrigerant to the high pressure pipe and to control the amount of refrigerant during the individual operation of indoor unit.

4) Solenoid valve (PWM)

It is installed at the top of digital scroll compressor and at the low pressure pipe, which is used for operating the digital scroll compressor. When the valve is open, the digital scroll compressor keeps the state of unloading.

5) Solenoid valve (HGBV)

When the low pressure gets lower, the valve is open by the low pressure safety device. The valve is open in order to reduce the load at the start of compressor and when the system stops and then keep the balance of low pressure.

6) Solenoid valve (LBV)

When the compressor is overheated, it actuates to lower the temperature of compressor for stable operation.

7) Solenoid valve (VBV)

The valve is open in order to reduce the load at the start of compressor and when the system stops and then keeps the balance of low pressure.

8) High pressure switch

To stop the system for the system protection when the high pressure exceeds the set value.

9) Temperature sensor (DTS, Discharge Temperature Sensor)

It is the means to measure the refrigerant temperature of compressor outlet which is used as the data for control of compressor.

10) Temperature sensor (COS, Condenser Out Sensor)

When heating, used for defrost control by sensing outdoor heat exchanger temperature.



- 11) **Temperature sensor (OATS, Outdoor Air Temperature Sensor)**  
To measure the outdoor temperature which is used for the determination of start method.
- 12) **Fixed scroll compressor**  
The fixed capacity type compressor.
- 13) **4-way valve (4-W/V)**  
It enables the change between cooling and heating by reversing the flow direction of refrigerant.
- 14) **Electronic expansion valve (EEV)**  
By sensing suction temperature and low pressure, controls the suction super heat and mass flow of refrigerant.
- 15) **Check valve (C/V)**  
To reduce the loss of pressure at the electronic expansion valve while cooling and to prevent the over-load of the compressor.
- 16) **SUC.S (Suction sensor)**  
To control EEV for optimized suction super heat to control over-heating at the electronic expansion valve by the temperature of the compressor suction part when heating.
- 17) **OIL.S (Oil sensor)**  
To control EEV against liquid back and low dilution of oil to protect the compressor by measuring the temperature of oil used for controlling SUMP at low temperature in cooling / heating mode.
- 18) **Temperature sensor (FDTS, Fixed Discharge Temperature Sensor)**  
It is the means to measure the refrigerant temperature of compressor outlet which is used as the data for control of fixed compressor.



# 7. Electric circuit diagram

## 7-1. Cooling only

(1) \*\*050/060/072\*\*

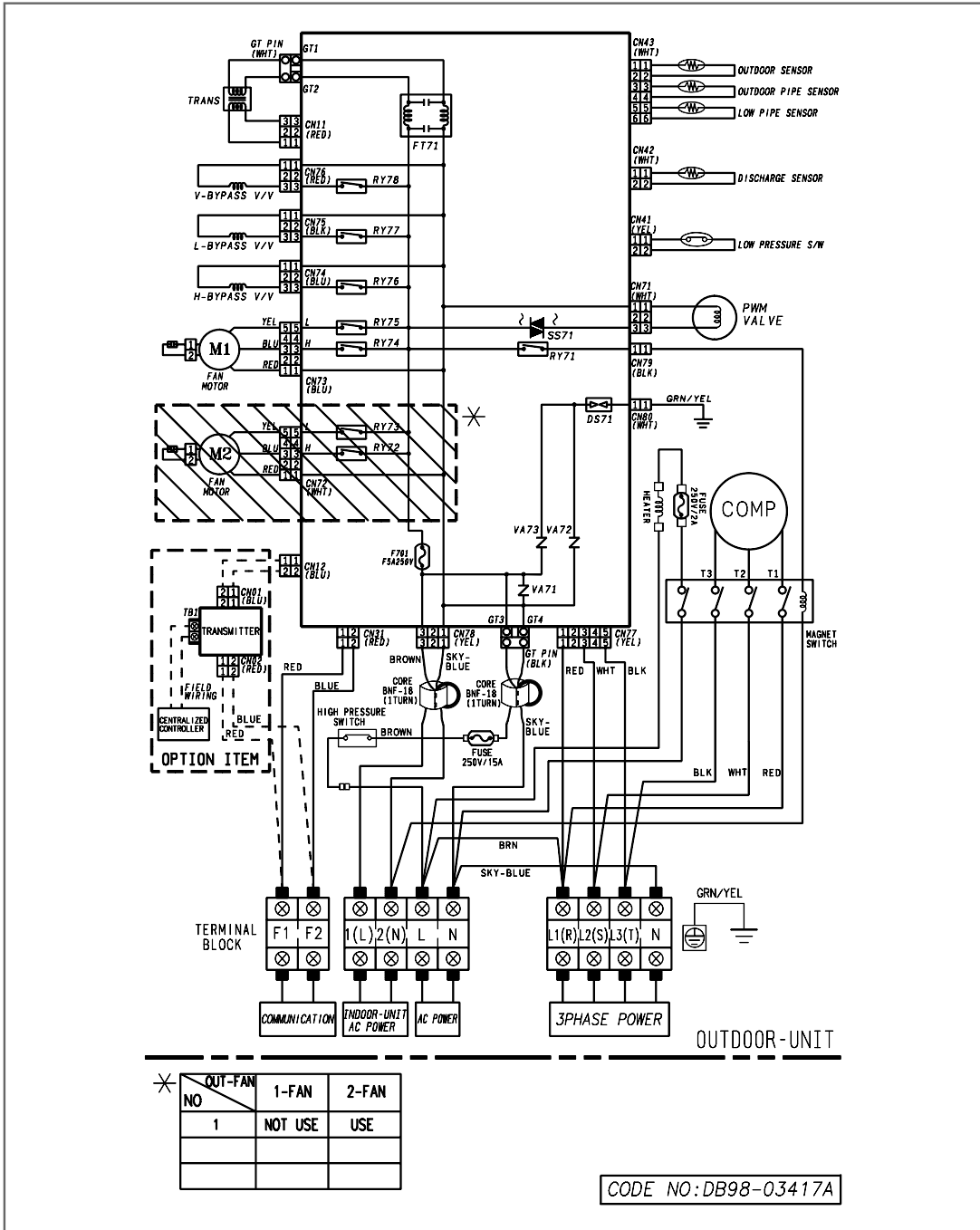

(2) \*\*080/100\*\*

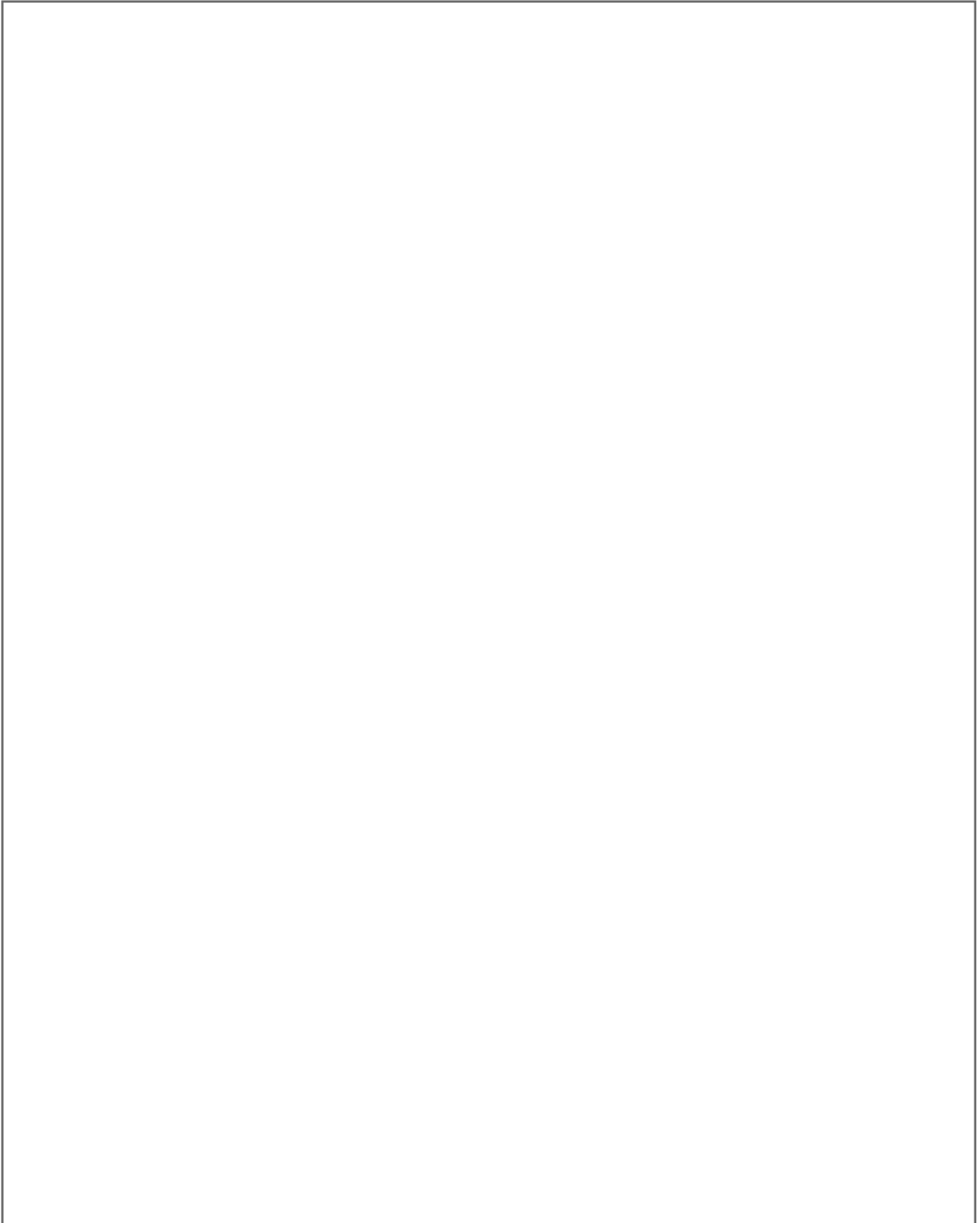



# 7. Electric circuit diagram

## 7-2. Heat pump

(1) \*\*050/060\*\*

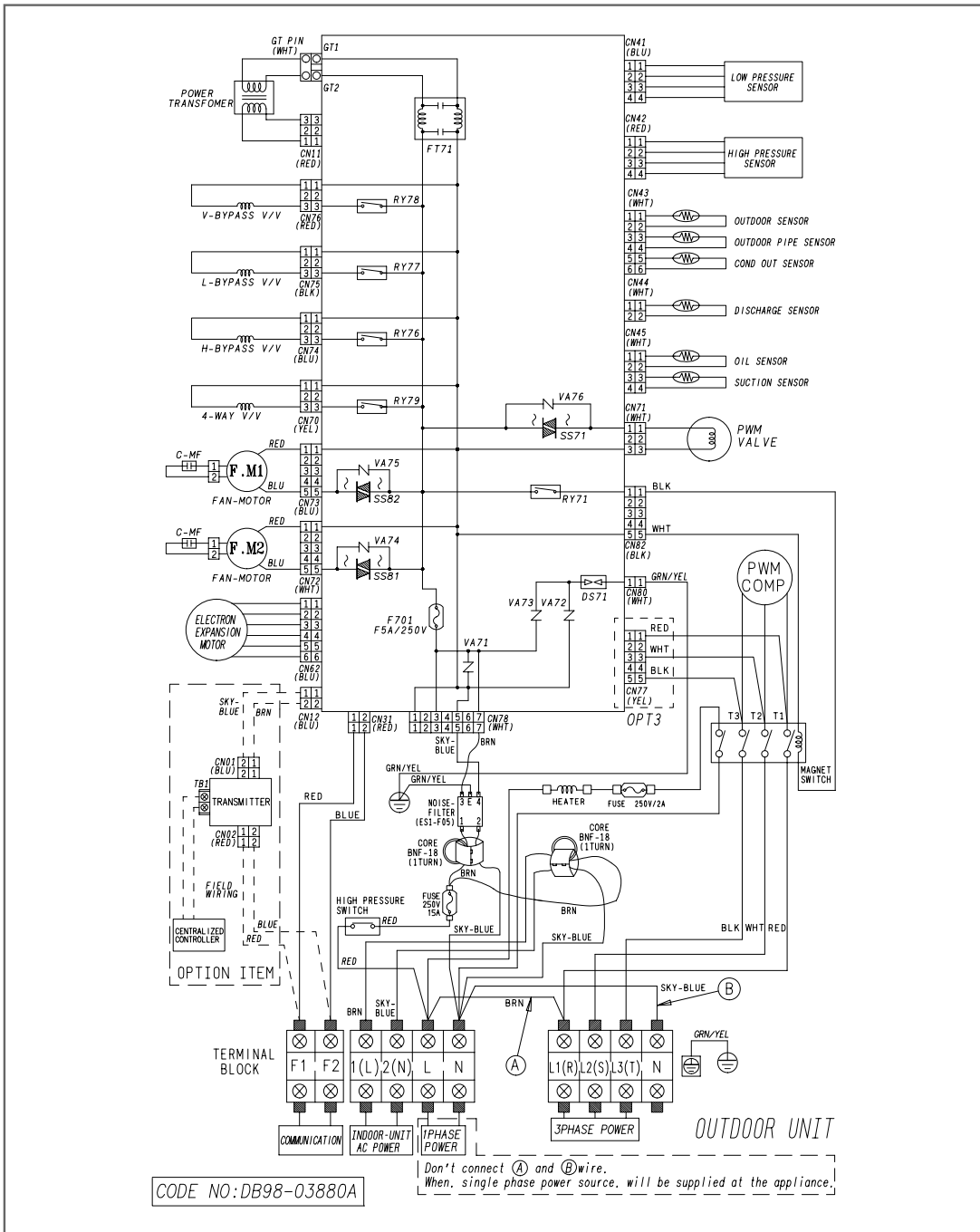

(2) \*\*080/100\*\*

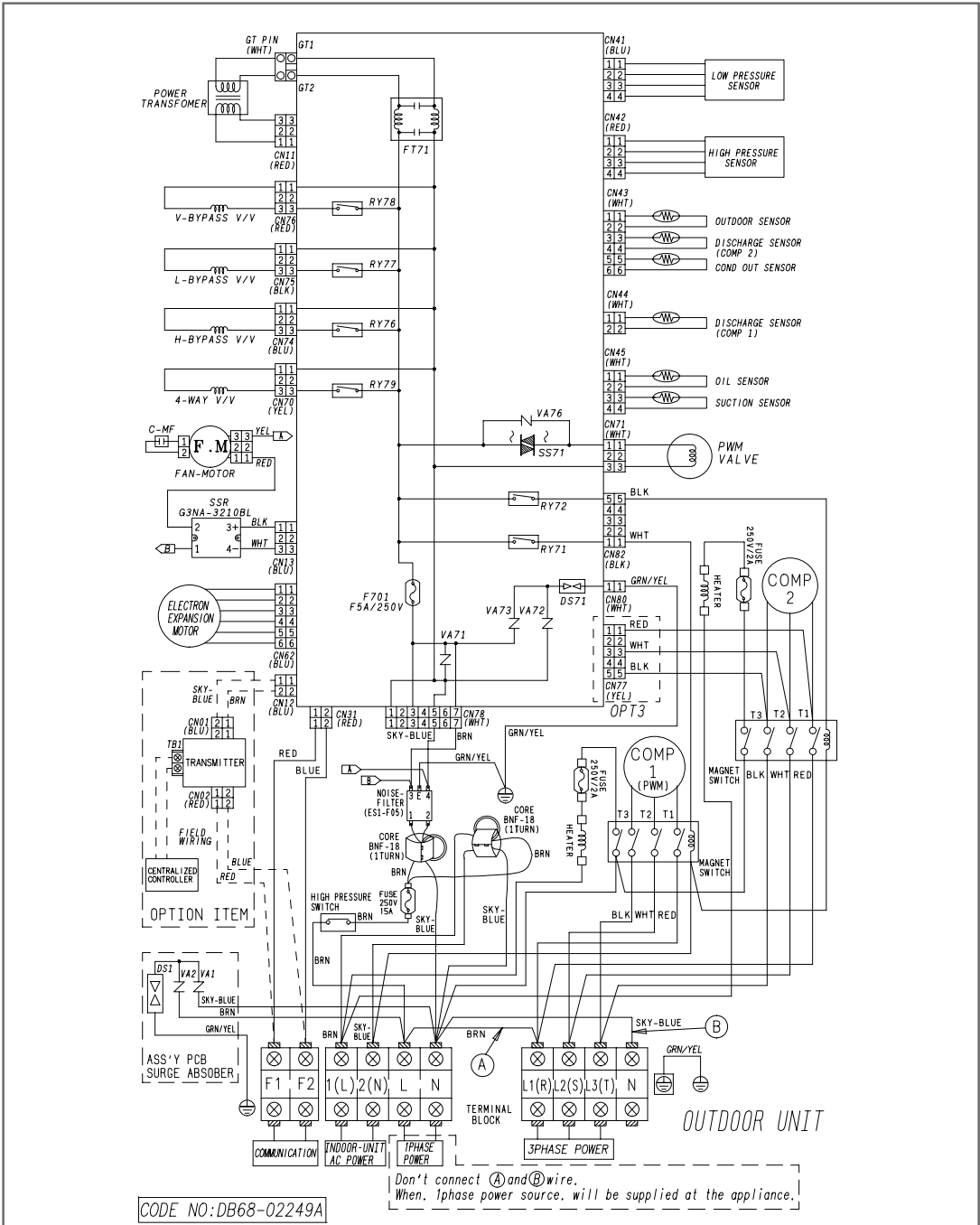



## 8. Consideration for outdoor unit selection

### 8-1. Change of capacity depending on refrigerant piping length

#### (1) Change of cooling capacity

#### (2) Change of heating capacity

Example of a mark :



## **8-2. Condition of operating restriction**

**(1) Cooling**

**(2) Heating**

**(3) Cautions for characteristics of heating capacity**



# 9. Noise level

**\*\*035\*\***

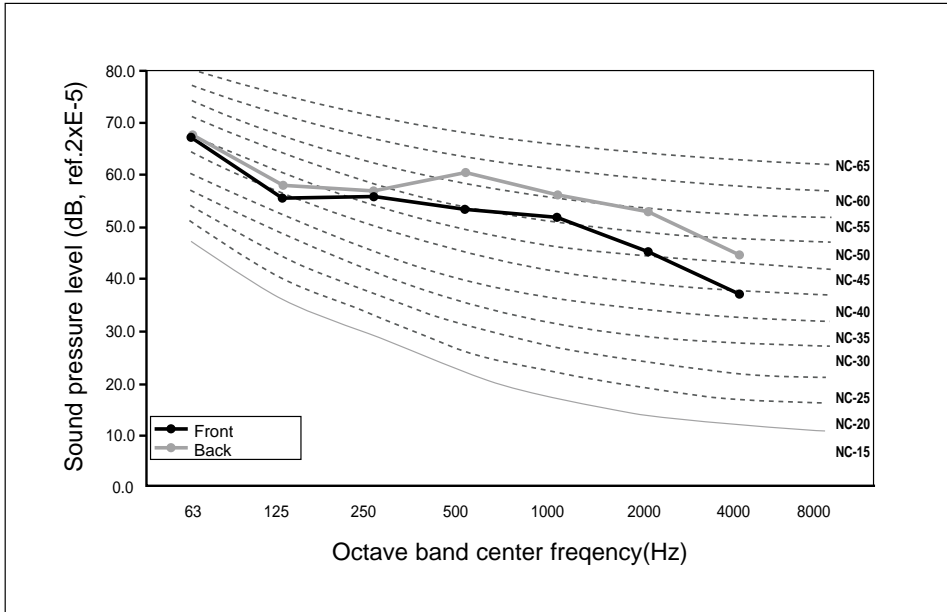

**\*\*075\*\***

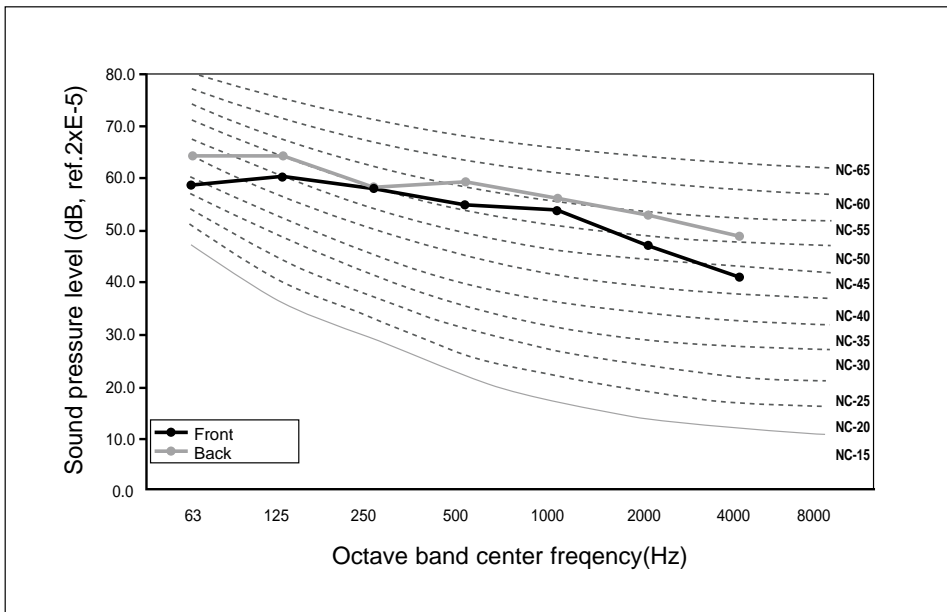



**\*\*060\*\***

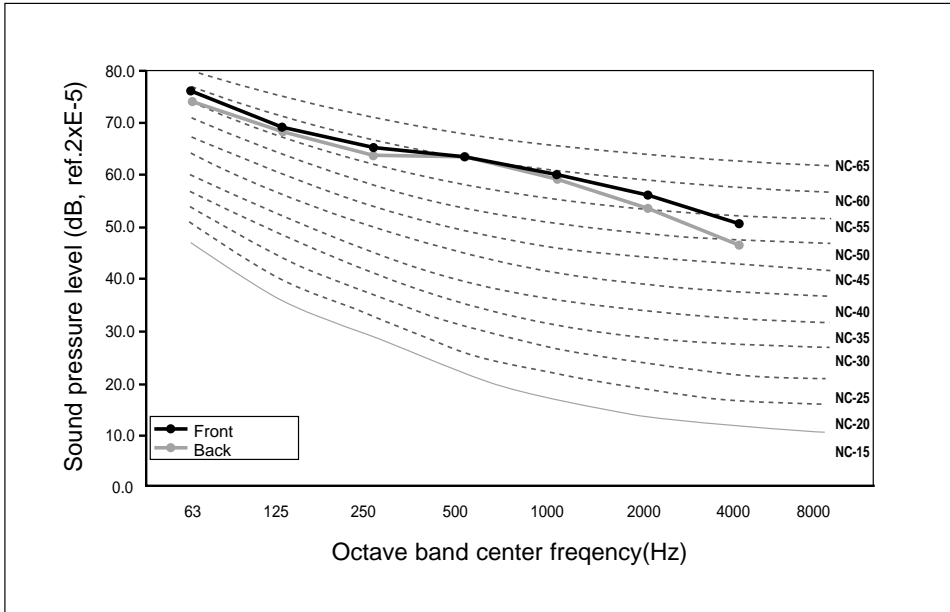



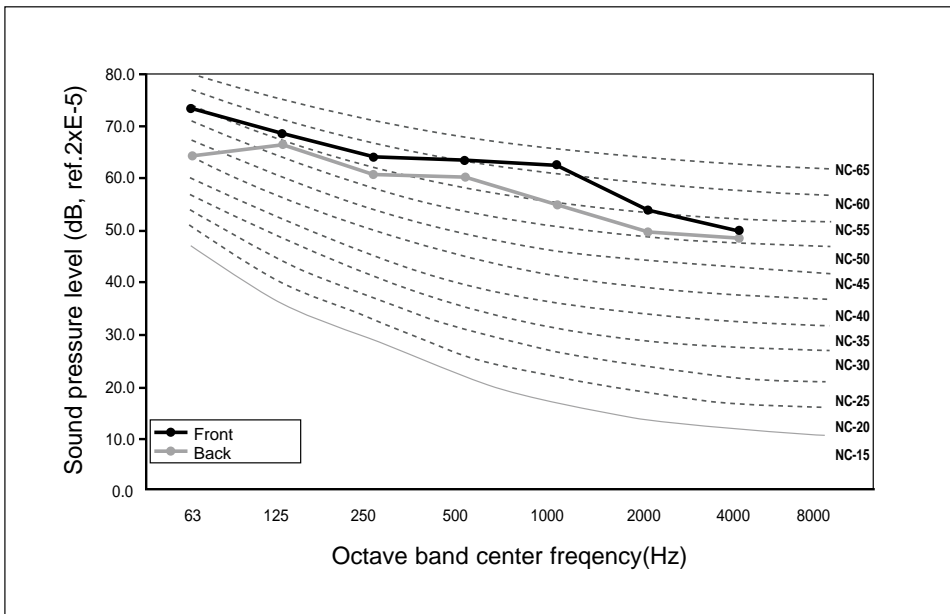

**\*\*080/100\*\***





## 10. Options

Design	Capacity (HP)	Optional Items				
		Discharge duct	Interface module	Centralized controller	SVM-SNET	Refnet kit
	5.0 ~ 7.5	MDF-45A (2 FAN)	MIM-B00	MCM-A200	-	
	5.0 ~ 6.0	MDF-46A (2 FAN)	MIM-B00	MCM-A200	-	MXJ-0906A MXJ-1206A MXJ-2212A MXJ-3112A
	8.0 ~ 10.0	??? (1 FAN)	MIM-B00	MCM-A200	-	
	7.5 ~ 10 (Supper cooler)	MDF-45A (1 FAN)	-	-	-	-

\* The discharge duct shall be bought suitable for the quantities of Fan.

# V

## Installation

1	Product	
	1-1. Preparation for installation .....	2
	1-2. Deciding on where to install the air conditioner .....	3
	1-3. Space requirements for the air conditioner .....	4
	1-4. Accessories .....	8
	1-5. Installation .....	11
2	Panel	
	2-1. 1-way cassette type .....	13
	2-2. 4-way cassette type .....	15
	2-3. Duct type (Built-in) .....	16
3	Connecting the indoor unit refrigerant pipe	
4	Drain hose installation	
5	Drain pump installation	
	5-1. Accessories .....	22
	5-2. Installation .....	22
6	Wiring	
	6-1. Overall system configuration .....	23
	6-2. Cable specification for outdoor unit .....	24
	6-3. Connection cord specification .....	24
	6-4. Wiring diagram .....	24
	6-5. Connection cord wiring diagram .....	25
	6-6. Power wiring and communication wiring configuration .....	25
	6-7. Communication cable connection .....	26
7	Piping and refnet joint selection	
	7-1. Refrigerant piping system diagram .....	33
	7-2. Piping selection .....	33
	7-3. Refnet joint selection .....	34
8	Charge/recovery of refrigerant	
	8-1. Refrigerant charging .....	35
	8-2. Additional refrigerant amount calculation method .....	36
	8-3. Recovery of refrigerant .....	37
9	Testing operation	
10	Cautions for refrigerant leaks	



# 1. Product

## 1-1. Preparation for installation

When deciding on the location of the air conditioner with the owner, the following restrictions must be taken into account.

### (1) General

Do NOT install the air conditioner in a location where it will come into contact with the following elements:

- ◆ Combustible gases
- ◆ Saline air
- ◆ Machine oil
- ◆ Sulphide gas
- ◆ Special environmental conditions

If you must install the unit in such conditions, first consult your dealer.

### (2) Moving the outdoor unit by wire rope

Fasten the outdoor unit by two 8m or longer wire ropes as shown at the figure. To protect damage or scratches, insert a piece of cloth between the outdoor unit and rope, then move the unit.

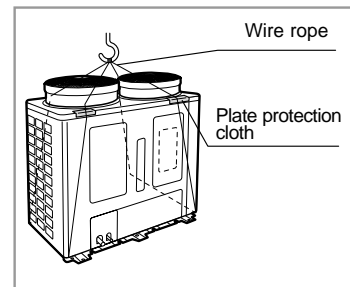

## 1-2. Deciding on where to install the air conditioner.

### (1) Indoor unit

- ◆ There must be no obstacles near the air inlet and outlet.
- ◆ Install the indoor unit on a ceiling that can support its weight.
- ◆ Maintain sufficient clearance around the indoor unit.
- ◆ Make sure that the water dripping from the drain hose runs away correctly and safely.
- ◆ The indoor unit must be installed in this way, that they are out of public access.  
(Not touchable by the users)

### (2) Outdoor unit

- ◆ The outdoor unit must NEVER be placed on its side or upside down, as the compressor lubrication oil will run into the cooling circuit and seriously damage the unit.
- ◆ Choose a location that is dry and sunny, but not exposed to direct sunlight or strong winds.
- ◆ Do not block any passageways or thoroughfares.
- ◆ Choose a location where the noise of the air conditioner when running and the discharged air do not disturb any neighbours.
- ◆ Choose a position that enables the pipes and cables to be easily connected to the indoor unit.
- ◆ Install the outdoor unit on a flat, stable surface that can support its weight and does not generate any unnecessary noise and vibration.
- ◆ Position the outdoor unit so that the air flow is directed towards the open area.
- ◆ Maintain sufficient clearance around the outdoor unit, especially from a radio, computer, stereo system, etc.

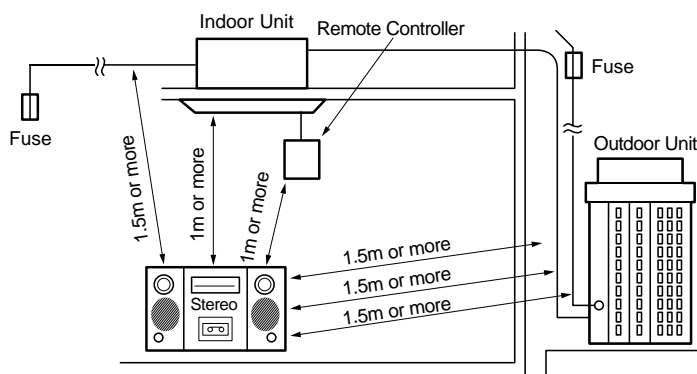

- ◆ If the outdoor unit is installed at a height, ensure that its base is firmly fixed in position.
- ◆ Make sure that the water dripping from the drain hose runs away correctly and safely.



◆ This device must be installed according to the national electrical rules.



# 1. Product

## 1-3. Space requirements for the air conditioner

### (1) Indoor unit

#### 1) 1-way cassette type

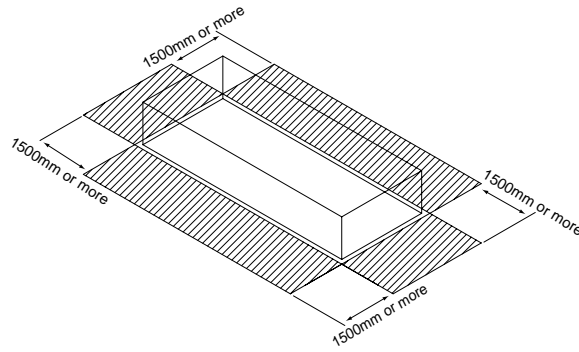

#### 2) 4-way cassette type

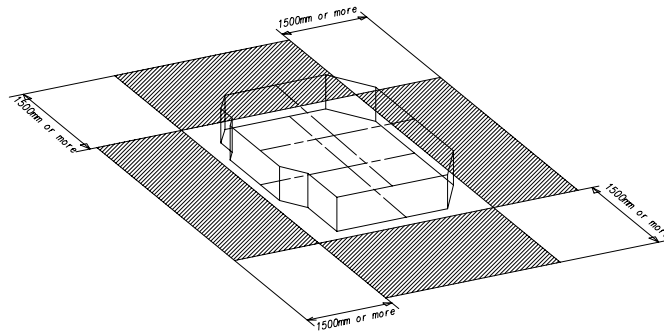

#### 3) Duct type (Low silhouette)

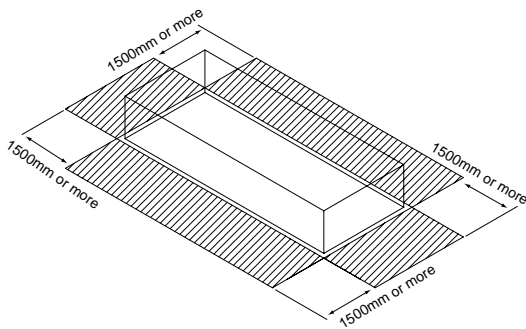

You must have 5mm or more space between the ceiling and the bottom of indoor unit. Otherwise, the noise from the vibration of indoor unit may bother the user.

#### 4) Duct type (Built-in)

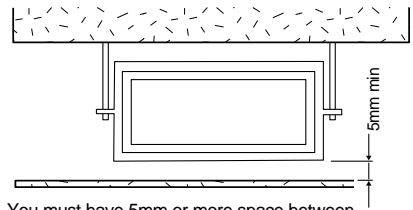
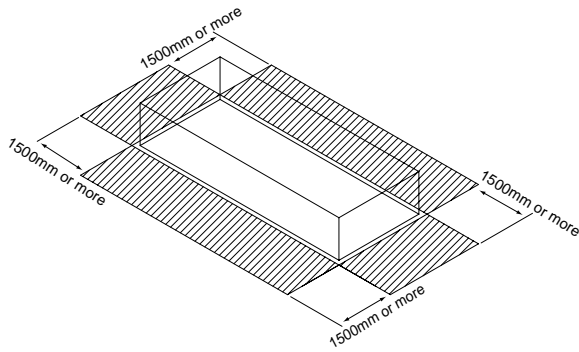

You must have 5mm or more space between the ceiling and the bottom of indoor unit. Otherwise, the noise from the vibration of indoor unit may bother the user.

#### 5) Duct type (High pressure)

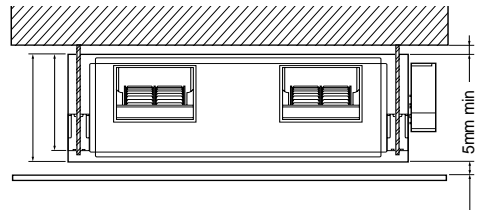
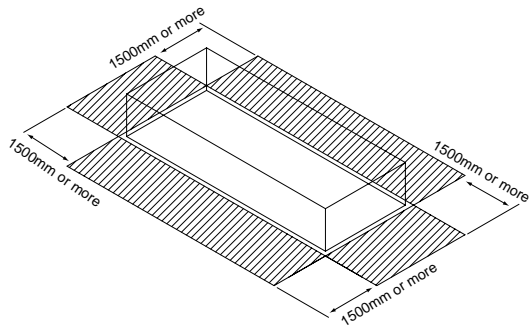

You must have 5mm or more space between the ceiling and the bottom of indoor unit. Otherwise, the noise from the vibration of indoor unit may bother the user.

#### 6) Wall-mounted type

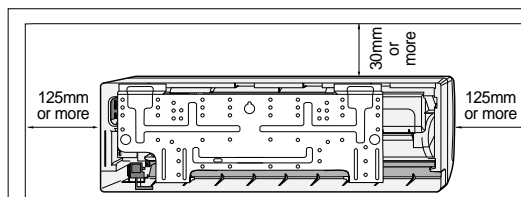



# 1. Product

## 7) Floor standing type

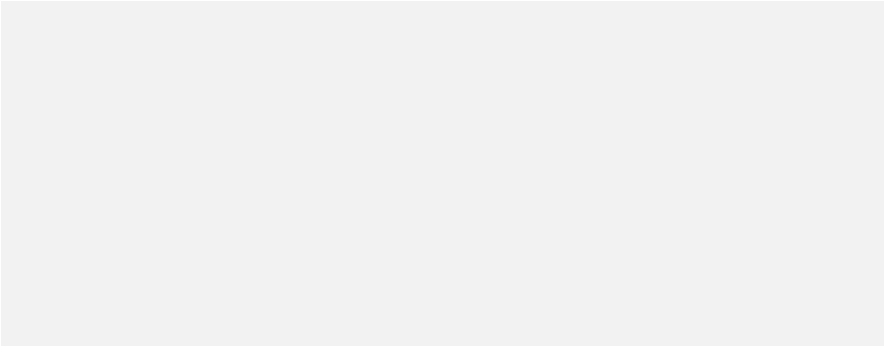

## 8) Ceiling type

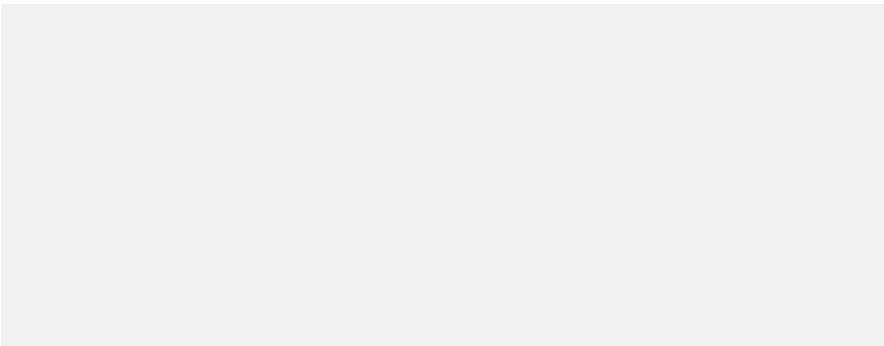



## (2) Outdoor unit

1) If there is no obstacle around the outdoor unit...

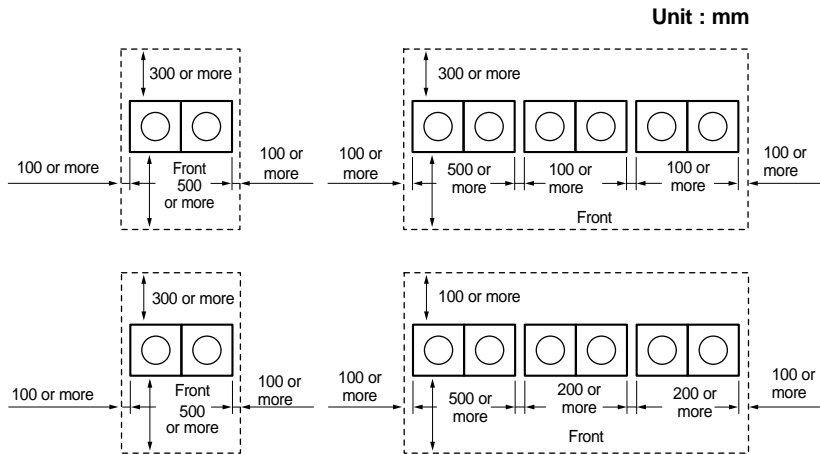

- \* Max. height of obstacle
- Front side : 1500mm or less
  - Air inlet side : 500mm or less
  - Right/Left side : No limit

2) If there is an obstacle around the outdoor unit...



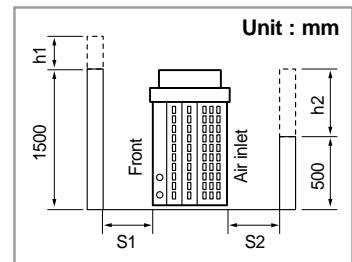

- ◆ If an obstacle in front of the outdoor unit is higher than 1500mm, the half of additional height should be added to the S1.
- ◆ If an obstacle behind the outdoor unit is higher than 500mm, the half of additional height should be added to the S2.





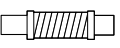









# 1. Product

## 1-4. Accessories



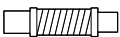

### (1) 1-way cassette type

Pattern sheet (1) 	Flexible hose (1) 	Insulation drain hose (1) 	Installation manual (1) 	Rubber (8) 
---	---	---	---	---



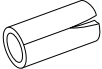
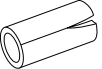





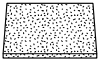

### (2) 4-way cassette type

Pattern sheet (1) 	Insulation cover drain (1) 	Insulation (2) 	Insulation cover band (1) 	Insulation pipe (2) 	Insulation drain hose (2) 
Installation manual (1) 	Cable-tie (5) 	Flexible hose (1) 	M4x12 tapped Screw (4) 	Pad stopper (1) 	Insulation drain sub (1) 





### (3) Duct type (Low silhouette)

Pattern sheet (1) 	Insulation A (2) 	Insulation B (2) 	Drain Socket (1) 	Owner's Instructions (1) 	Installation Manual (1) 
---	--	--	--	--	--



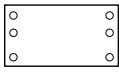
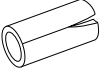
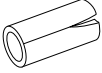



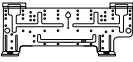

#### (4) Duct type (Built-in)

Pattern sheet (1) 	Insulation cover drain (1) 	Insulation (2) 	Insulation cover band (1) 	Insulation pipe (2) 	Insulation drain hose (2) 
Cable-tie (5) 	Flexible hose (1) 	Insulation drain sub (1) 	Owner's Instructions (1) 	Installation manual (1) 	

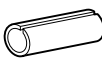
#### (5) Duct type (High pressure)

Pattern sheet (1) 	Insulation A (2) 	Insulation B (2) 	Drain Socket (1) 	Owner's Instructions (1) 	Installation Manual (1) 
--	---	---	---	---	--

#### (6) Wall-mounted type

Installation plate (1) 	Cement nail (6) 	Insulation refrigerant pipe (1) 	Cable tie (4) 
Tapped screw (6) 	Putty (1) 	Owner's Instructions (1) 	Installation manual (1) 



# 1. Product

## (7) Floor standing type

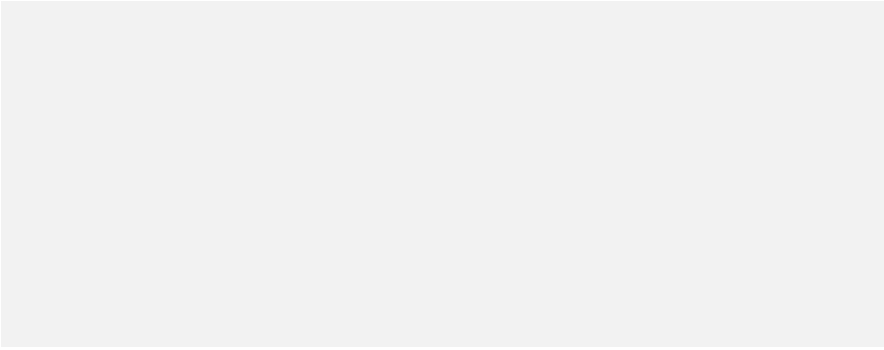

## (6) Ceiling type

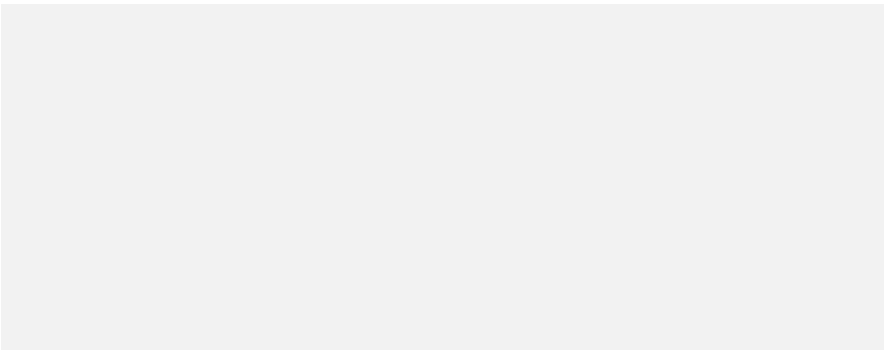

## 1-5. Installation

### (1) Indoor unit (Example; 4-way cassette type)

- 1) Place the pattern sheet on the ceiling at the spot where you want to install the indoor unit.

**Note** ◆ Since the diagram is made of paper, it may shrink or stretch slightly due to temperature or humidity. For this reason, before drilling the holes maintain the correct dimensions between the markings.

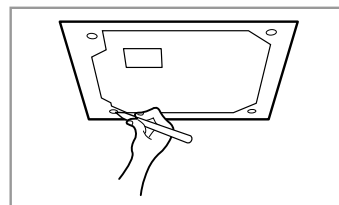

- 2) Insert bolt anchors, use existing ceiling supports or construct a suitable support as shown in figure.

**IMPORTANT** ◆ Ensure that the ceiling is strong enough to support the weight of the indoor unit. Before hanging the unit, test the strength of each attached suspension bolt.

◆ If the length of suspension bolt is more than 1.5m, it is required to prevent vibration.

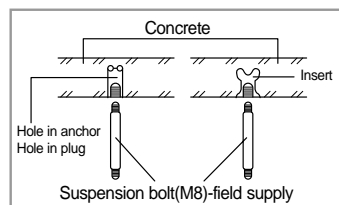

- 3) Install the suspension bolts depending on the ceiling type.

- 4) Screw eight nuts to the suspension bolts making space for hanging the indoor unit.

**IMPORTANT** You must install the suspension bolts more than four when installing the indoor unit.

- 5) Hang the indoor unit to the suspension bolts between two nuts.

**Note** ◆ Piping must be laid and connected inside the ceiling when suspending the unit. If the ceiling is already constructed, lay the piping into position for connection to the unit before placing the unit inside the ceiling.

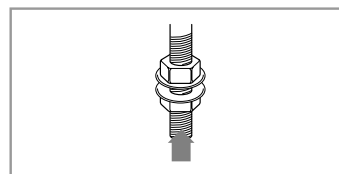
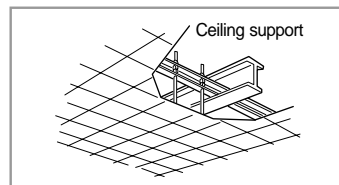

- 6) Screw the nuts to suspend the unit. Cut a pad stopper and place it on the bracket at this time.

- 7) Adjust the unit to the appropriate position considering the installation area for the front panel.

7-1 Place the pattern sheet on the indoor unit.

7-2 Adjust a space between the ceiling and the indoor unit by using the gauge of dimensions.

7-3 Fix the indoor unit securely after adjusting level of the unit by using a leveler.

7-4 Remove the pattern sheet, connect the other cables and install the front panel.

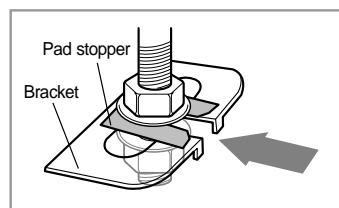

**Note** ◆ For installation of another indoor unit, refer to an appropriate installation manual.

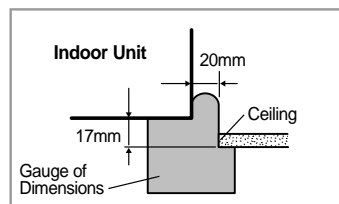



# 1. Product

## (2) Outdoor unit

The outdoor unit must be installed on a rigid and stable base to avoid any increase in the noise level and vibration, particularly if the outdoor unit is to be installed in a location exposed to strong winds or at a height, the unit must be fixed to an appropriate support(wall or ground).

1) Fix the outdoor unit with anchor bolts.

**Note** ♦ The anchor bolt must be 20mm or higher from the base surface.

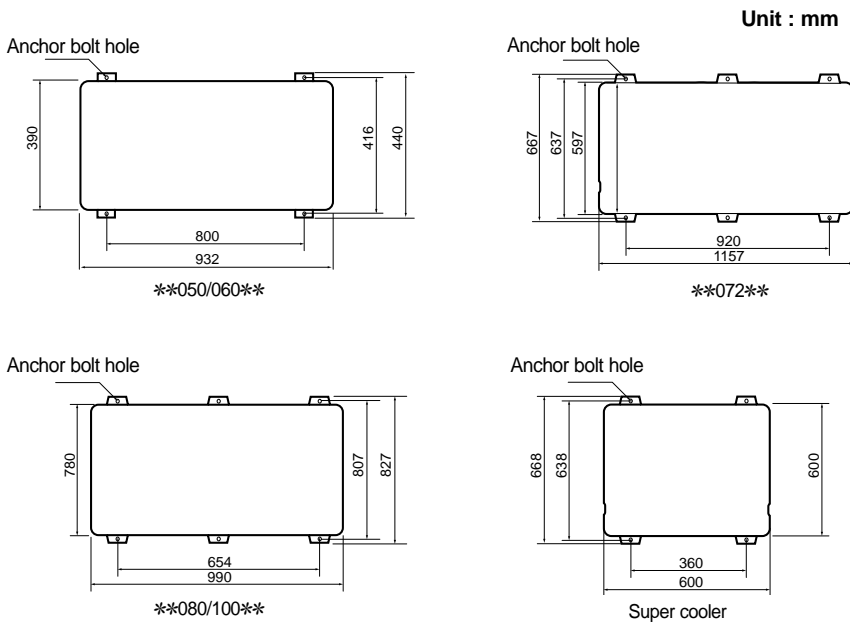



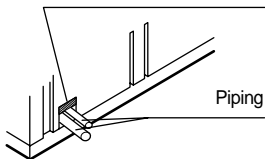





To prevent the unit against a wild animal or something, cover part after connecting the pipe.



## 2. Panel

### 2-1. 1-way cassette type

#### (1) Accessories

M4x12 tapped screw (6) 	M5x16 bolt (4) 				
Wireless remote controller (1) 	Battery (2) 	STS 2S-2x10 tapped screw (2) 	Remote control holder (1) 	Owner's instructions (1) 	Installation manual (1) 

#### (2) Installation

1) Open the front grille by pushing tabs on the grille.

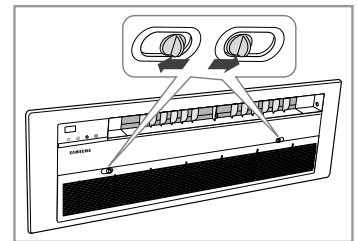

2) Remove safety clips to open the grille completely.

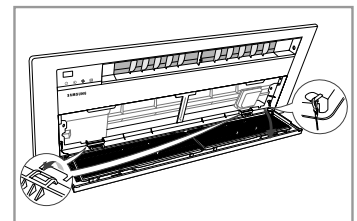

3) Attach the panel to the indoor unit temporarily with 6 screws, then adjust it not to leave a gap between the ceiling and the panel.

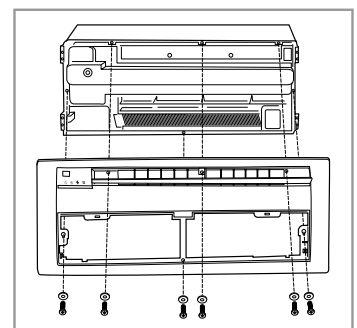



## 2. Panel

4) Install the air flow blade.

4-1 Fix the right part of the blade to the indoor unit.

4-2 Fix the other side of the blade.

**IMPORTANT** ♦ If the direction is incorrect, the blade will not be inserted smoothly. Check that prominence of the right side has a small rectangular groove.

4-3 Fix the middle part of the blade by pushing slightly the middle tab in the indoor unit.

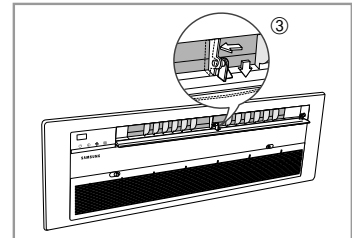
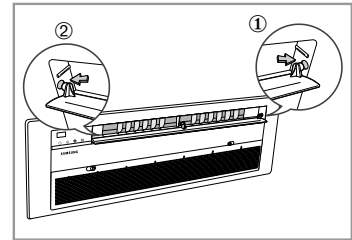

5) Open the electrical component box by removing screws, then connect cables between the electrical component box and the panel.

**IMPORTANT** ♦ Be careful about the color of cables not so that they will be mixed up.

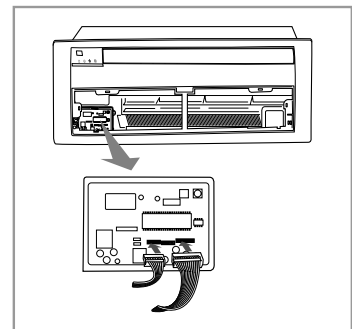

6) Fix the panel by fastening 4 bolts; the bolt can be fastened up to 15mm.

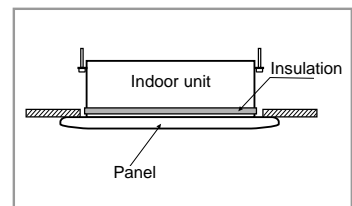
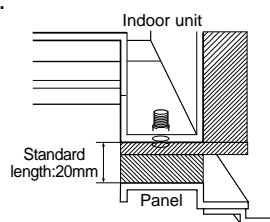

**\*Caution\*** ♦ If there is a gap between the panel and the ceiling, adjust the height of the indoor unit. Unless adjust the height, dew may form and drip from the gap.

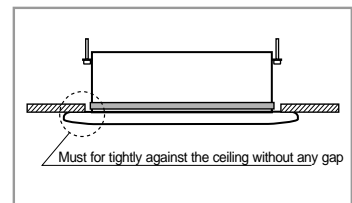







7) Reinstall the front grille.



## 2-2. 4-way cassette type

### (1) Accessories

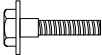
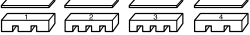
Wireless remote controller (1) 	Battery (2) 	Remote control holder (1) 	Owner's instructions (1) 	Owner's instructions (1) 
4x12 Tapped screw (2) 	Bolt (4) 	Air blocking kit (1)  Must be separately purchased		

### (2) Installation

1) Open the electrical component box cover removing the screws.

2) Install the panel using two hooks on the both sides of the indoor unit.

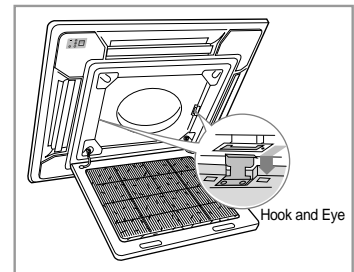

3) Connect the cables of the panel to the PCB as shown in figure.

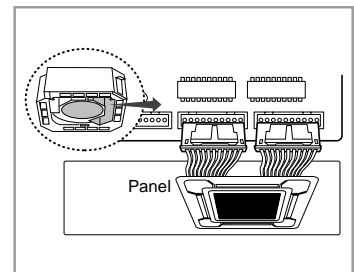

4) Close the electrical component box cover and secure the screws.

5) Secure the panel to the indoor unit using the bolts(4EA).

- ◆ There are four kinds of air blocking kits. Fill up the air outlet(s) with one or more kits depending on the situation, then install the insulation to block air completely.

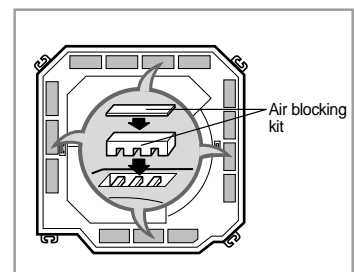
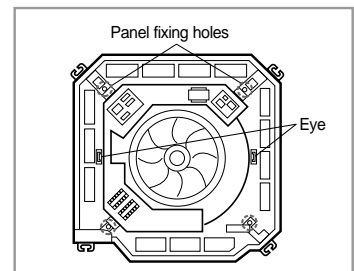



## 2. Panel

### 2-3. Duct type (Built-in)

#### (1) Accessories

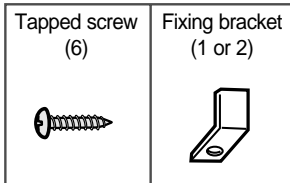

#### (2) Installation

1) Separate the front grille from the panel.

1-1 Push the lever of front grille right and left to lift it up and then open it.

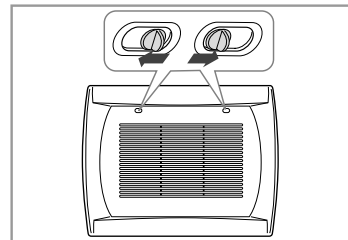

1-2 Take out the safety clip at the both sides of front grille and separate the front grille.

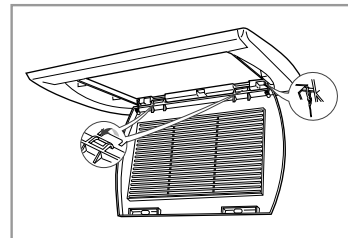

2) Insert panel fixing screws(4EA or 5EA) and tighten them temporarily. Leave space of approx. 7~8mm between the screw and the indoor unit to insert the panel. Do not insert the screw into the rest of one or two hole(s) yet.

**\*\*020/026/035\*\***

◆ Tighten 5 screws except one hole for fixing a bracket.

**\*\*052/070\*\***

◆ Tighten 4 screws except two holes on right and left.

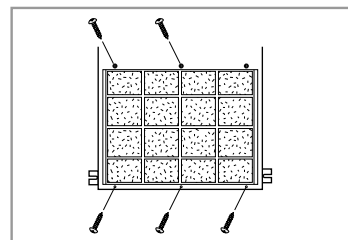

- 3) Attach the panel to the indoor unit, then push it to right or left to secure the panel. Narrow side of hole on the panel must be inserted between the screw and the indoor unit.

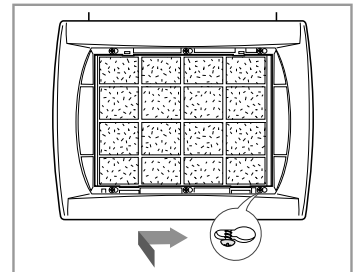

- 4) Adjust the location of panel so that there is no gap between the panel and ceiling, then tighten the screw completely.

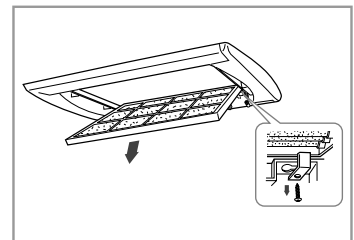

- 5) Install the fixing bracket. Each air filter needs its own bracket.

**\*\*020/026/035\*\***

- ◆ Fix 1 bracket to the rest hole on the panel with a supplied screw.

**\*\*052/070\*\***

- ◆ Fix 2 brackets to two holes on right and left side of the panel with screws.

- 6) Reinstall the front grille.

- ◆ The installation of front grille is in the reverse order of disassembly.



### 3. Connecting the indoor unit refrigerant pipe

**There are two refrigerant pipes of differing diameters:**

- ◆ A smaller one for the liquid refrigerant
- ◆ A larger one for the gas refrigerant
- ◆ The inside of copper pipe must be clean & has no dust.

- 1) Remove the pinch pipe on the pipes and connect the assembly pipes to each pipe, tightening the nuts, first manually and then with a wrench, a spanner applying the following torque.

Outer Diameter	Torque (kgf•cm)
6.35 mm (1/4")	144~176
9.52 mm (3/8")	333~407
12.70 mm (1/2")	504~616
15.88 mm (5/8")	630~770
19.05 mm (3/4")	990~1210
22.23 mm (7/8")	990~1210

**Note** ◆ If the pipes must be shortened refer to page 19.

- 2) Must use insulator which is thick enough to cover the refrigerant pipe to protect the condensate water on the outside of pipe falling onto the floor and the efficiency of the unit will be better.
- 3) Cut off any excess foam insulation.
- 4) Be sure that there must be no crack or wave on the bended area.
- 5) It would be necessary to double the insulation thickness (10mm or more) to prevent condensation even on the insulator when if the installed area is warm and humid.
- 6) Shape an oil trap as shown in figure. The oil trap must be formed every level difference of 10m.

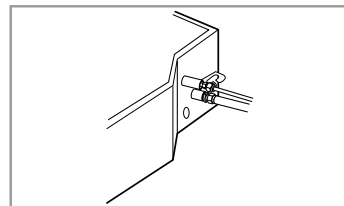
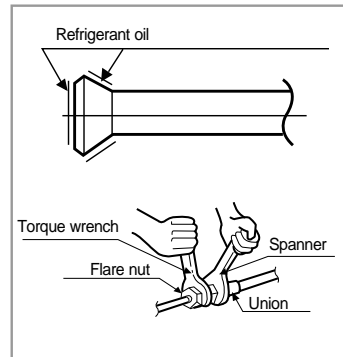

**When the indoor unit is above the outdoor unit**

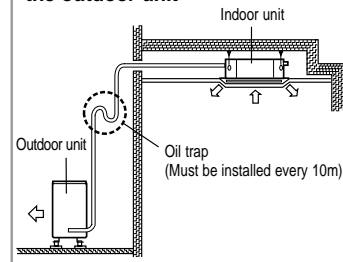

**When the outdoor unit is above the indoor unit**

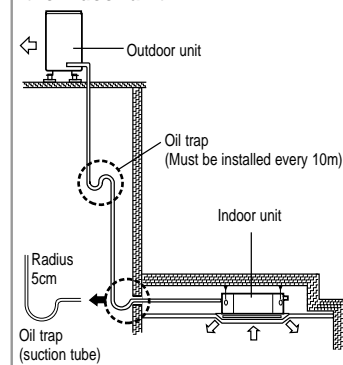

## Cutting/Flaring the Pipes

- 1) Make sure that you have the required tools available (pipe cutter, reamer, flaring tool and pipe holder).
- 2) If you wish to shorten the pipes, cut it with a pipe cutter, taking care to ensure that the cut edge remains at a 90° angle with the side of the pipe. Refer to the illustrations below for examples of edges cut correctly and incorrectly.

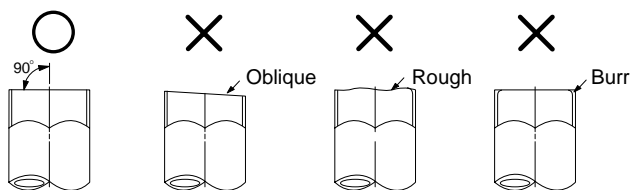
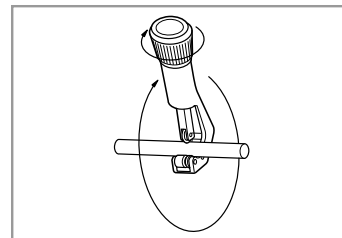

- 3) To prevent any gas from leaking out, remove all burrs at the cut edge of the pipe, using a reamer.

- 4) Slide a flare nut on to the pipe and modify the flare.

Outer Diameter (D)	Depth (A)
6.35 mm (1/4")	1.3mm
9.52 mm (3/8")	1.8mm
12.70 mm (1/2")	2.0mm
15.88 mm (5/8")	2.2mm
19.05 mm (3/4")	2.2mm
22.23 mm (7/8")	2.2mm

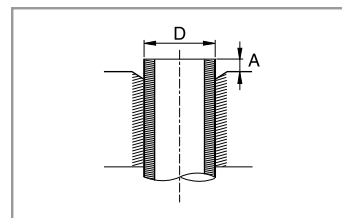

- 5) Check that the flaring is correct, referring to the illustrations below for examples of incorrect flaring.

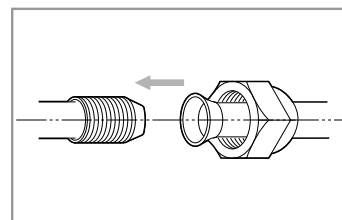
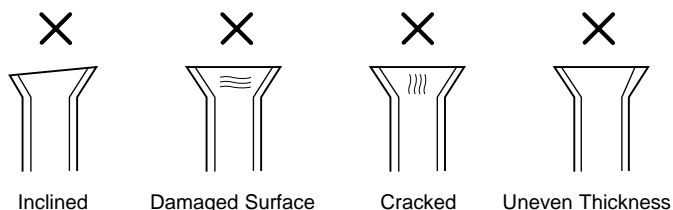

- 6) Align the pipes and tighten the flare nuts first manually and then with a wrench, applying the following torque.

Outer Diameter	Torque (kgf•cm)
6.35 mm (1/4")	144~176
9.52 mm (3/8")	333~407
12.70 mm (1/2")	504~616
15.88 mm (5/8")	630~770
19.05 mm (3/4")	990~1210
22.23 mm (7/8")	990~1210



◆ In case of welding the pipe, you must weld with nitrogen gas blowing.



## 4. Drain hose installation (Example;4-way cassette type)

**Care must be taken when installing the drain hose for the indoor unit to ensure that any condensate water is correctly drained outside.**

1) Insert the flexible hose to the drain hose port.

**Note** ◆ Attach the drain hose to the drain hose port with an adhesive for PVC and tape to prevent water leaks, then secure the hose with a band etc..(The band is not supplied with the air conditioner.)

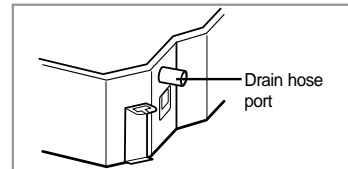

2) Install the drain hose so that its length can be as short as possible. Internal diameter of the drain hose should be the same or slightly bigger than the external diameter of the drain hose port.

◆ Inner diameter of the drain hose

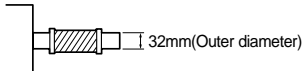

**Note** ◆ Give a slightly slant to the drain hose for proper drainage of condensate.  
◆ Secure the drain hose with an adhesive for PVC and tape not to be separated from the unit.

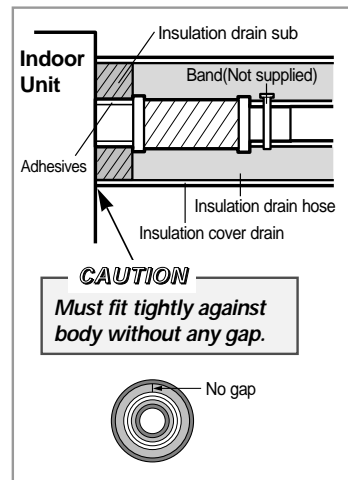

3) Wrap the drain hose with the insulation drain as shown in figure and secure it.

### CAUTION

**Check that the indoor unit is level with the ceiling by using the leveler.**

Install air ventilation to drain condensate water smoothly.

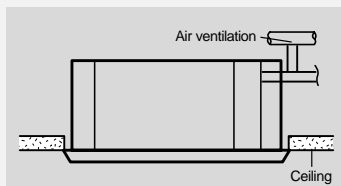

Do not give the hose and upward gradient after the connection port. This will cause water to flow backwards when the unit is stopped, resulting in water leaks.

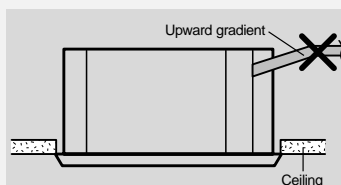

If it is necessary to increase the height of the drain hose somewhat, the portion directly after 30cm. If it is raised higher than 50cm, there can be water leaks.

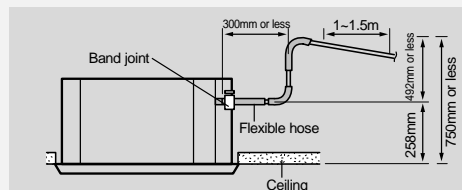

Do not apply force to the piping on the unit side when connecting the drain hose. The hose should not be allowed to hang loose from its connection to the unit. Fasten the hose to a wall, frame or other support as close to the unit as possible.

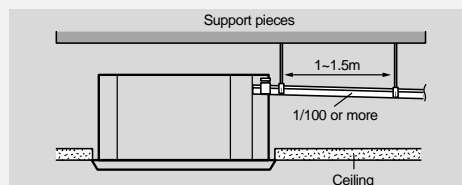

**Note** ◆ If a concentrated drain hose is installed, refer to the figure below.

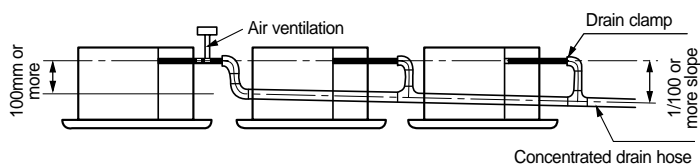

## Testing the drainage

*You should test the drainage after completing the installation.  
Prepare a little water about 2.0 liter.*

1) Remove two screws on the cover water supply intake and pull out the cover.

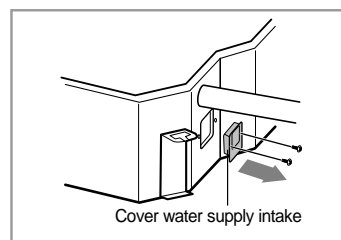

2) Pour water into the indoor unit as shown in figure.

**Note** ◆ If you do not pour water inside the water supply intake, water may spill from the indoor unit.

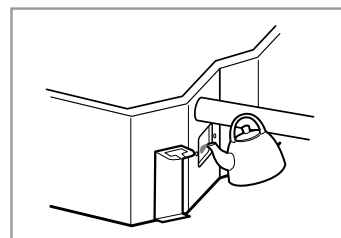

3) Confirm that the water flows out through the drain hose.

**Note** ◆ You can check the drainage only when the air conditioner is in cool mode.

4) Reassemble the cover drain pump and the screws.

**Note** ◆ For installation of another drain hose, refer to an appropriate installation manual.

# 5. Drain pump installation-optional

(Example;Low-silhouette duct type)

## 5-1. Accessories

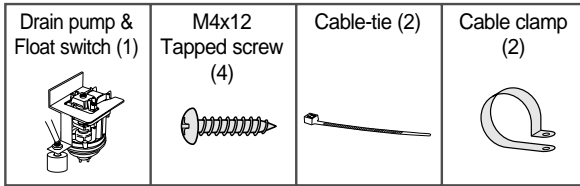

## 5-2. Accessories

(1) Connect the cable to the electrical component box as shown at the figure.

**Note** ◆ Connect the drain pump cable to yellow terminal(CN74) and the float switch to black terminal(CN51).

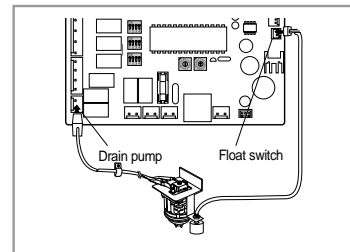

(2) Screw the drain pump to the side of the indoor unit with two screws.

**Note** ◆ When installing the drain pump, leave a 7mm space between the bottom of the drain pan and the drain pump.

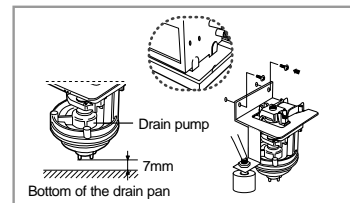

(3) Adjust K4 DIP switch(SW03) to the "OFF" position.

Switch No.	Switch Position	Using Drain Pump
K4	ON	X
	OFF	O

**Note** ◆ Wrap the drain tube outlet on the right and left side of the indoor unit with an insulating materials.

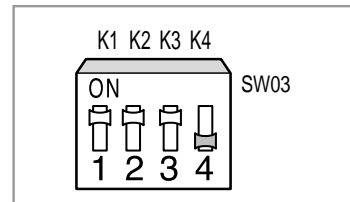



# 6. Wiring

## ■ Caution

- All wiring and parts shall be the rated ones.
- For details of wiring, refer to the circuit diagram attached onto the outdoor unit.
- The electrical work shall be performed by the qualified electrical worker.
- The circuit diagram for wiring shows only the concept and so the details for actual work is not described.
- This air conditioner is consist of 3 phase 4 wire system and so the main circuit breaker to block the power shall be installed in the integrated manner.
- Be sure to install the circuit breaker and fuse on power cable of each equipment.
- Connect the wires to the terminals without excessive force and arrange the wires with the cover or other parts so that it may not be loosened. If it is loosened, it may cause the overheating, electrical shock and fire.

## 6-1. Overall system configuration (example)

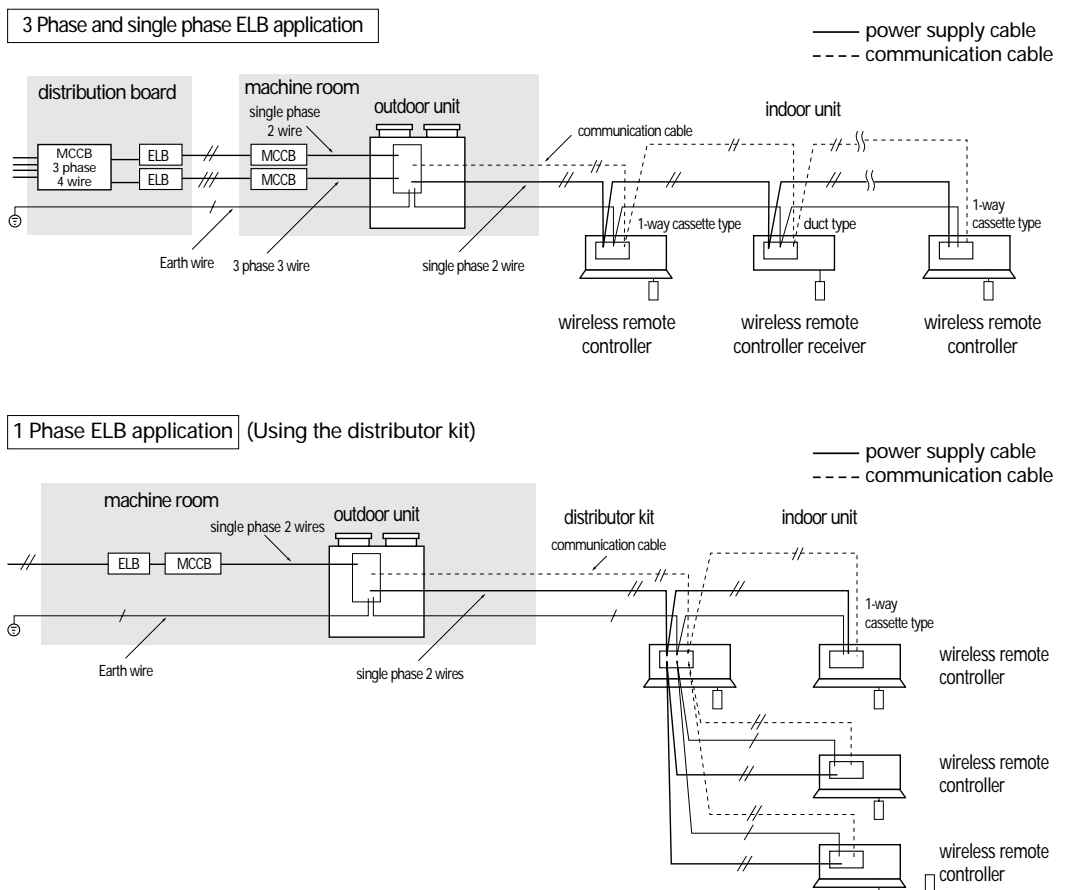

## 6. Wiring

### 6-2. Cable specification for outdoor unit

Outdoor unit		Power supply										earth wire	communication cable (VCTF, 2wires)	
		3 phase					single phase							
		Power supply	Max/Min (V)	MCCB	ELB	power cable	wire length	Power supply	Max/Min (V)	MCCB	ELB			power cable
3 phase	5.0HP or less	380V/60Hz 380-415V/50Hz	± 10% V	Frame:30A Trip:20A	20A	3.5mm <sup>2</sup> , CV, 3wires	less than 16m	220V/60Hz 220-240V/50Hz 208-230V/60Hz 200-220V/50Hz	± 10% volt	15A	15A	2.0mm <sup>2</sup> , CV, 2wires	1.6mm, IV, 1wire	0.75-1.25mm <sup>2</sup>
	6.0-8.0 HP	208-230V/60Hz 380V/60Hz 380-415V/50Hz	± 10% V	Frame:50A Trip:30A	30A	5.5mm <sup>2</sup> , CV, 3wires	less than 18m							
	10.0HP	208-230V/60Hz 460V/60Hz 380V/60Hz 380-415V/50Hz	± 10% V	Frame:75A Trip:50A	50A	8.0mm <sup>2</sup> , CV, 3wires	less than 18m							
1 phase	5.0HP	220V/60Hz 220-240V/50Hz 208-230V/60Hz 200-220V/50Hz	± 10% V	Frame:75A Trip:50A	50A	8.0mm <sup>2</sup> , CV, 2wires	less than 10m					1.6mm 1v, 1wire	0.75-1.25mm <sup>2</sup>	

### 6-3. Connection cord specification

Power supply (1 phase)			Earth wire	Communication cable (VCTF, 2wires)	Home server (VCTF, 2wires)
Power supply	Max/Min (V)	Power cable			
220V / 60Hz 220-240V/50Hz 208-230V/60Hz 200-220V/50Hz	± 10% V	2.0mm <sup>2</sup> (CV, 2wires)	1.6mm (IV, 1wire)	0.75-1.25mm <sup>2</sup>	0.75-1.25mm <sup>2</sup>

- \*Caution\***
- The power supply cable shall be connected to the power supply terminal and shall be fixed with clamp as in the following figure.
  - The unbalance of power shall be within 2% of power supply rating.
    - If the power supply unbalance is great, the lifetime of condenser is shortened.
    - If the power supply unbalance exceeds 4%, the indoor unit stops and error mode displays.

### 6-4. Wiring diagram

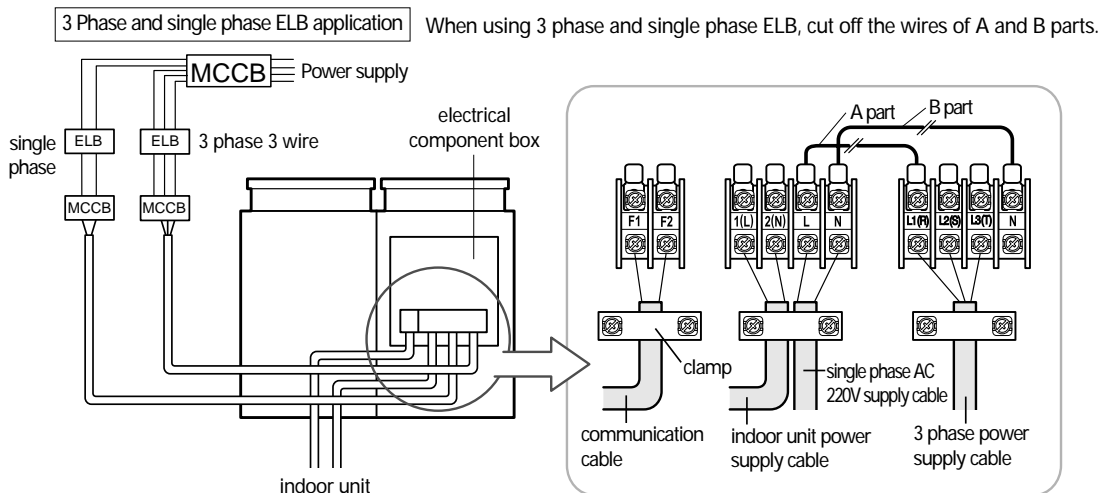

## 6-5. Connection cord wiring diagram

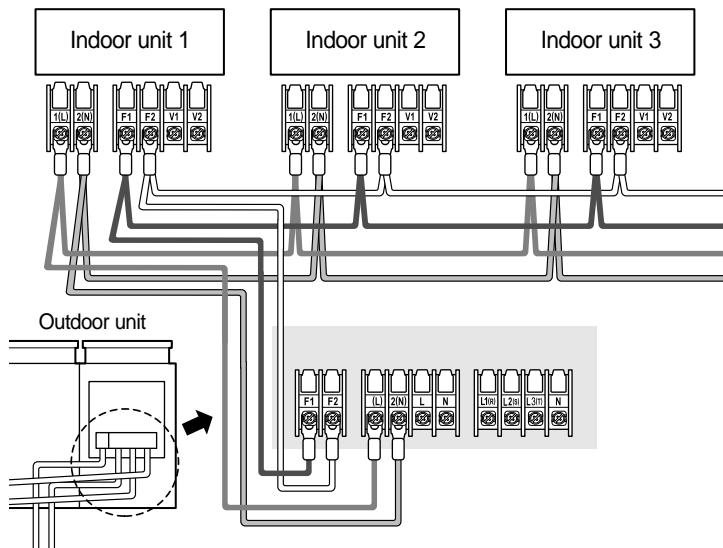

- \*Caution\***
- The communication cable shall be wired as follows:
    - When the communication cable exceeds the specified length, the operation of air conditioner may be impossible due to the trouble of communication between indoor and outdoor unit.
      - Maximum wire length : less than 120 m
      - Total wiring length : less than 240 m
      - Maximum communication branch cable: 10 branches

## 6-6. Power wiring and communication wiring configuration

- Be sure to run the power supply cable and communication cable through the electrical conduit as shown in the right side figure.
- Select the power supply cable from the left and right knockout hole of outdoor unit.
- The communication cable, indoor power cable and main power cable shall be run through the aluminum protection tube and separated with the distance of 50 mm.

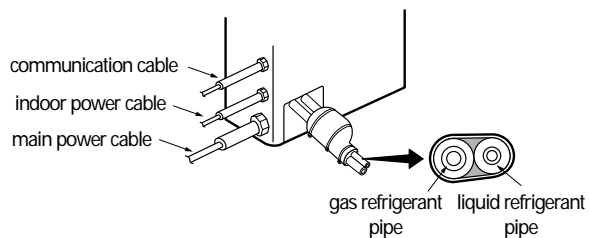

- \*Caution\***
- Be sure to install the power supply cable with the separation distance from the communication cable.
  - Take care that the pipe and wire do not contact each other.

# 6. Wiring

## 6-7. Communication cable connection

### (1) Correct connection

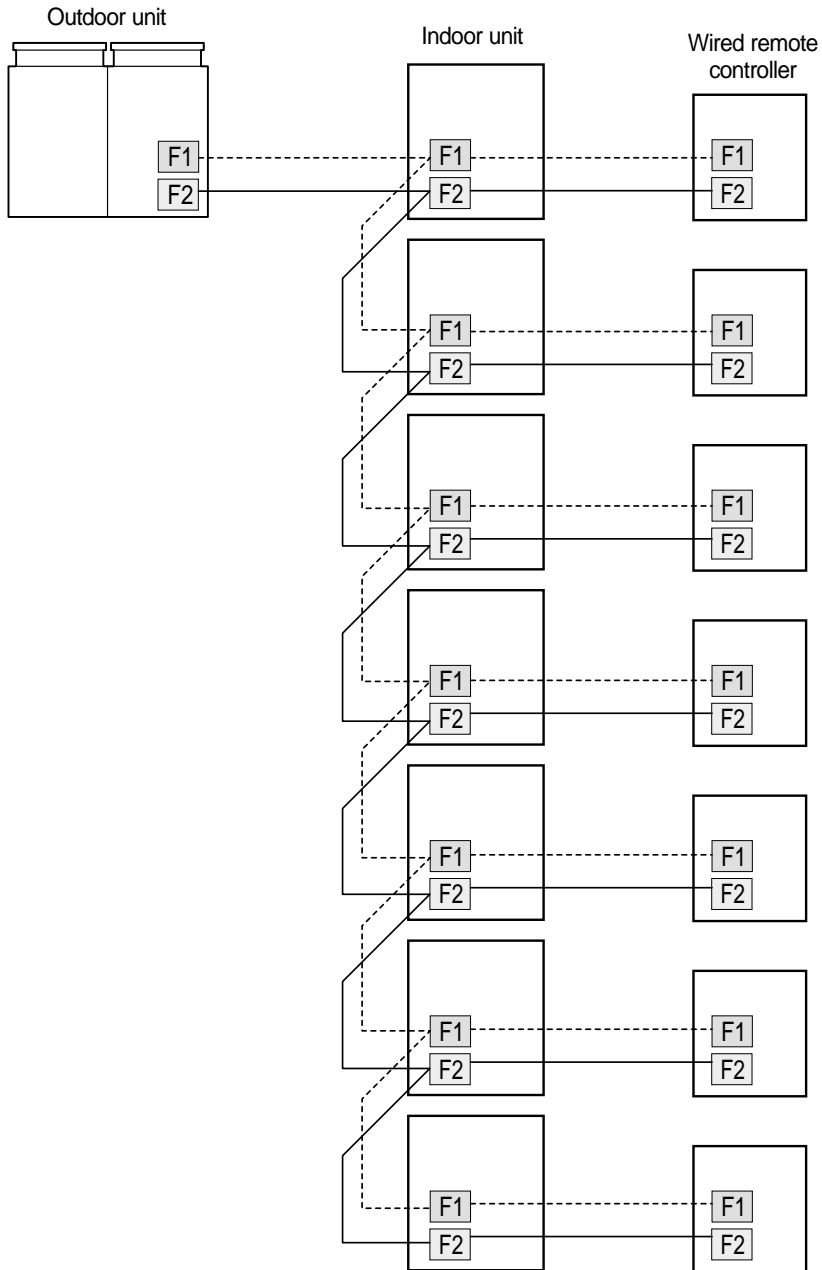

**(2) Typical wiring error**

1) Star wiring connection to some of the indoor units

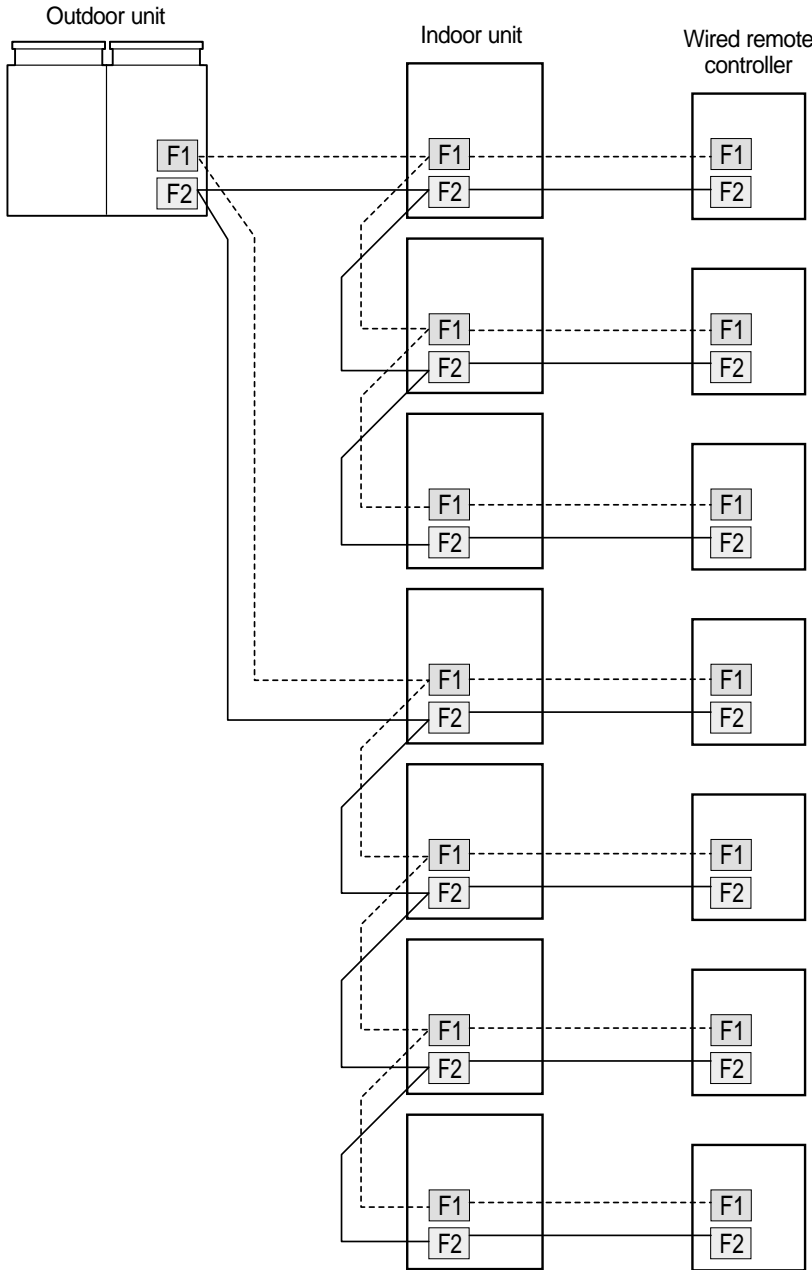

# 6. Wiring

## 2) Star wiring connection to every indoor units

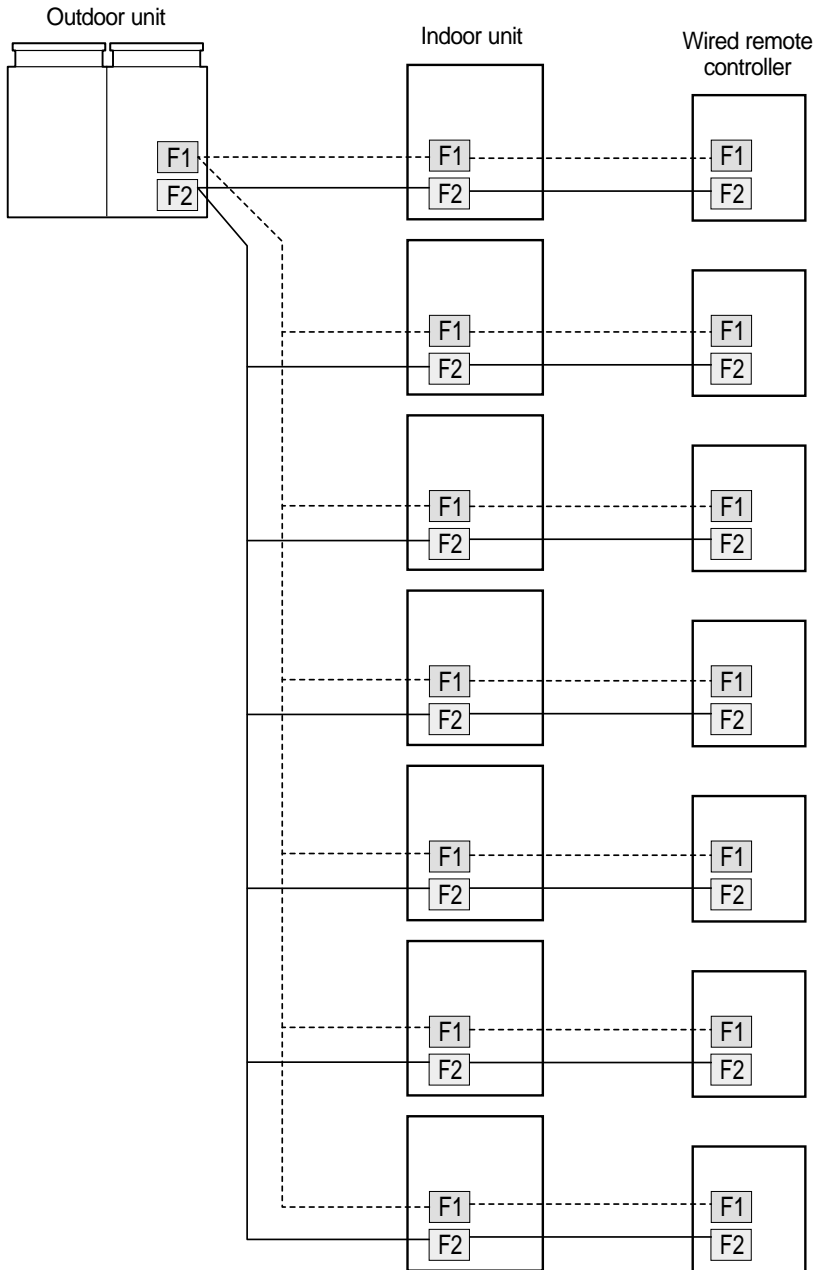

### 3) Reverse wiring between indoor and outdoor units

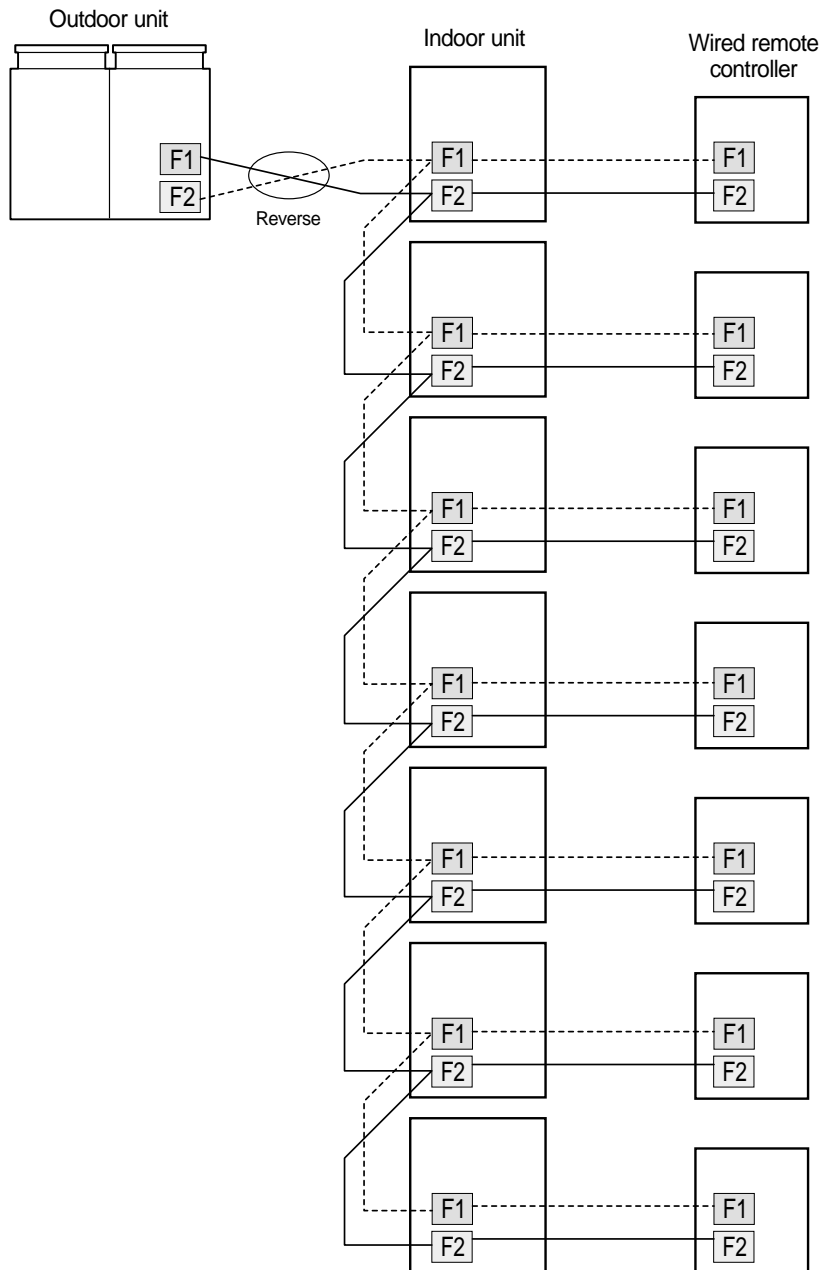

# 6. Wiring

## 4) Disconnection between indoor and outdoor units

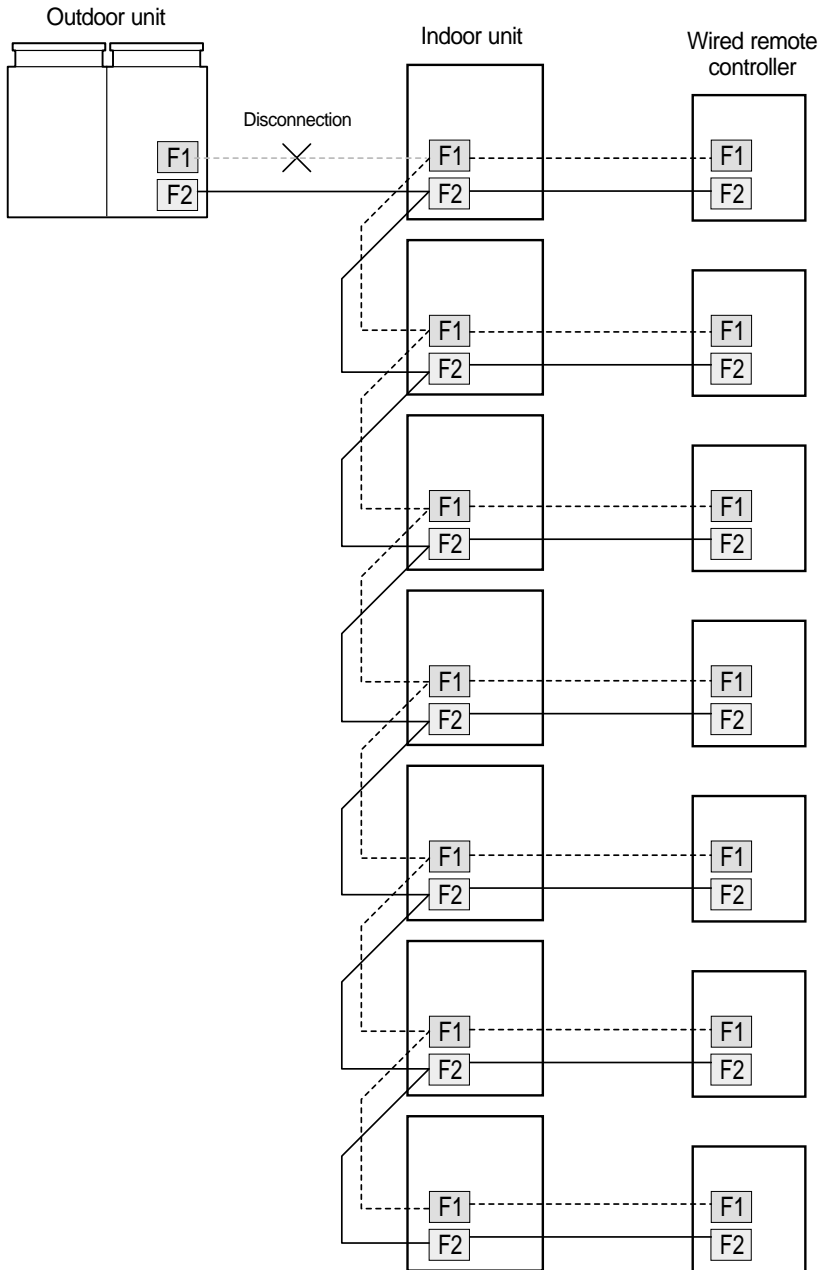



### 5) Reverse wiring between indoor units

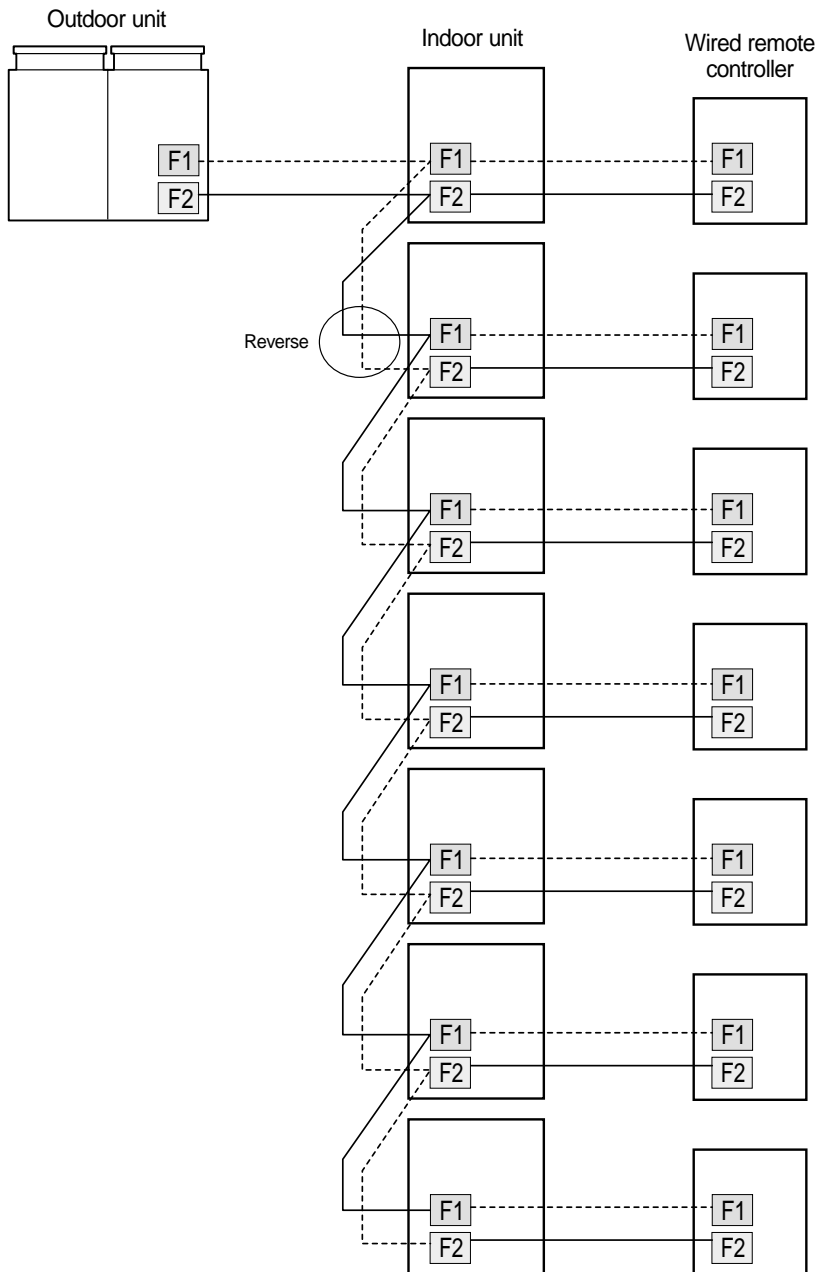

# 6. Wiring

## 6) Disconnection between indoor units

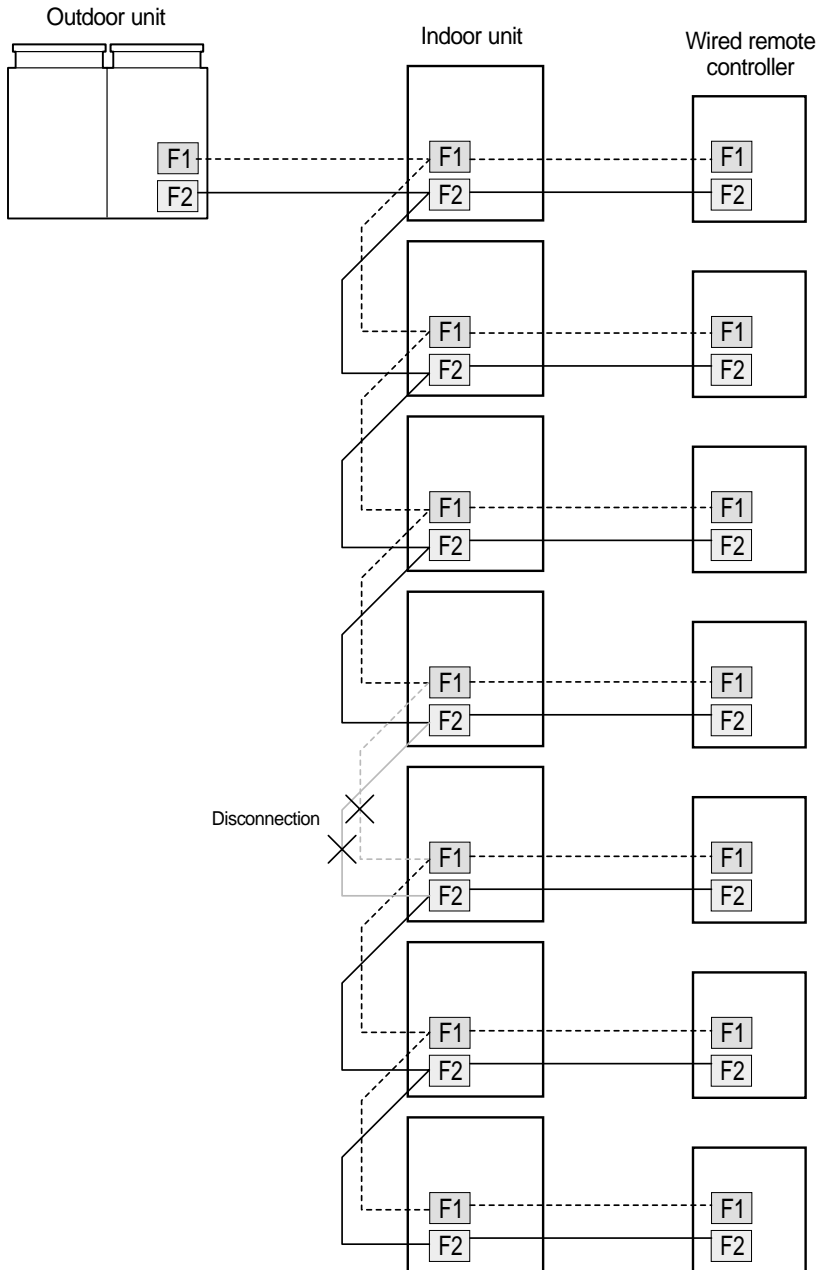

# 7. Piping and refnet joint selection

## 7-1. Refrigerant piping system diagram

Example) in case of 6 indoor units installation

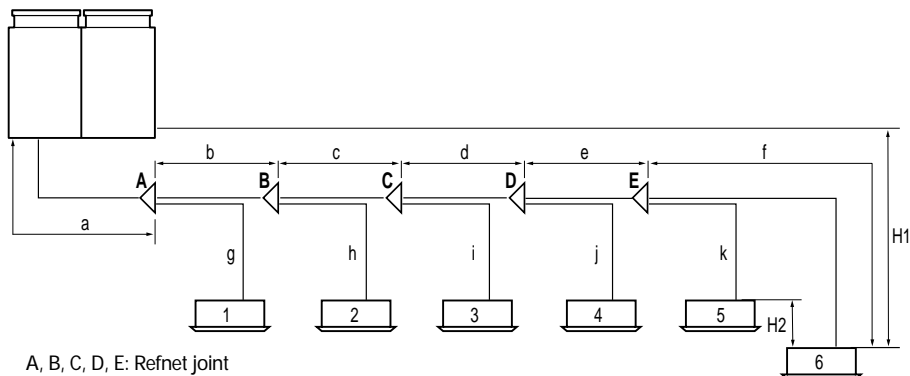

A, B, C, D, E: Refnet joint

Max allowable length	Distance between the farther indoor unit and outdoor unit	Less than 100m of piping length between outdoor unit and indoor unit Example) $a+b+c+d+e+f \leq 100$ m (6 sets)
Allowable difference height	Distance difference between indoor unit and outdoor unit	Reverse fall difference : shorter than 50m, fall difference : shorter than 30m (H1)
	Height difference between adjacent indoor units	Height difference between adjacent indoor units: shorter than 15m (H2)
Allowable length after branching	Actual pipe length	The distance from the first refnet joint to the indoor : shorter than 30m example ) $b+c+d+e+f \leq 30$ m $b+c+i \leq 30$ m
		The difference between the max piping length and min piping length from 1 refnet joint $\leq 20$ m

## 7-2. Piping selection

Items		Outdoor unit capacity	5.0HP	6.0HP	7.5HP	8.0HP	10.0HP
Outdoor unit - The first refnet joint piping							
Piping size	Liquid pipe		$\phi 9.52\text{mm} \times t0.8$		$\phi 12.70\text{mm} \times t0.9$		
	Gas pipe		<ul style="list-style-type: none"> <li>distance between the farther indoor unit and outdoor unit : less than 50m, <math>\phi 19.05\text{mm} \times t1.2</math></li> <li>distance between the farther indoor unit and outdoor unit : 50-70m, <math>\phi 25.4\text{mm} \times t1.2</math></li> </ul>		$\phi 25.40\text{mm} \times t1.2$	$\phi 28.60\text{mm} \times t1.2$	
Refnet joint - Refnet joint piping							
Liquid pipe (size)	Capacity limit of rear indoor unit side	less than 16000W	$\phi 9.52\text{mm} \times t0.8$				
		more than 16000W	-	$\phi 12.70\text{mm} \times t0.9$			
Gas pipe (size)	Capacity limit of rear indoor unit side	less than 9000W	$\phi 15.88\text{mm} \times t1.0$				
		9000W-16000W	$\phi 19.05\text{mm} \times t1.2$				
		16000W-21000W	-	$\phi 25.40\text{mm} \times t1.2$			
		more than 21000W	-	$\phi 28.60\text{mm} \times t1.2$			
Refnet joint - Indoor unit pipe							
Liquid pipe (pipe size)	Capacity limit of rear indoor unit side	less than 4700W	$\phi 6.35\text{mm} \times t0.7$				
		more than 4700W	$\phi 9.52\text{mm} \times t0.8$				
Gas pipe (pipe size)	Capacity limit of rear indoor unit side	less than 4700W	$\phi 12.70\text{mm} \times t0.9$				
		4700W-8500W	$\phi 15.88\text{mm} \times t1.0$				
		more than 8500W	$\phi 19.05\text{mm} \times t1.2$				

## 7. Piping and refnet joint selection

### 7-3. Refnet joint selection

#### (1) Selection method of first refnet joint from the outdoor unit

The first refnet joint (joint A) from the outdoor unit shall be selected according to the outdoor unit model.

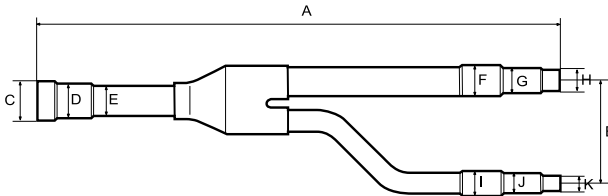

Refnet joint model	Length (mm)		Diameter (mm)									
	A	B	C	D	E	F	G	H	I	J	K	
MXJ-0906A	420	80	9.7	-	-	9.7	6.5	-	9.7	6.5	-	
MXJ-1206A	420	80	12.8	-	-	12.8	9.7	6.5	12.8	9.7	6.5	
MXJ-2212A	460	90	22.4	19.2	16.0	19.2	16.0	12.8	16.0	12.8	-	
MXJ-3212A	460	90	31.9	28.7	25.6	25.6	19.2	16.0	19.2	16.0	12.8	

#### (2) Other refnet joint selection method

The refnet joint except the first one shall be selected according to the capacity of indoor unit installed.

Total capacity of indoor unit (W)	Refnet joint model	
	Liquid side	Gas side
less than 16000	MXJ-0906A	MXJ-2212A
more than 16000	MXJ-1206A	MXJ-3112A

## 8. Charge/recovery of refrigerant

### 8-1. Refrigerant charging

**(1) Outdoor unit is charged with refrigerant when being delivered but additional refrigerant shall be charged for some part of system.**

**(2) After completion of vacuum, keep the following instructions to fill the refrigerant into the service port.**

- 1) Check whether the stop valve of liquid and gas side are completely closed.
- 2) Fill the specified amount of refrigerant from the liquid stop valve service port at the compressor stopped.

- \*Caution\***
- If the length of refrigerant piping is longer than specified, be sure to charge the refrigerant.
  - Do not charge the refrigerant from the gas side service port.
  - If the refrigerant charging is not done in the above method, press the refrigerant charging button (key2) on outdoor unit PCB to operate the unit. After approximately 30 minutes, charge the specified amount of refrigerant to the service port of gas stop valve. If unavoidable, check the pressure table as per the outdoor temperature to charge the refrigerant.

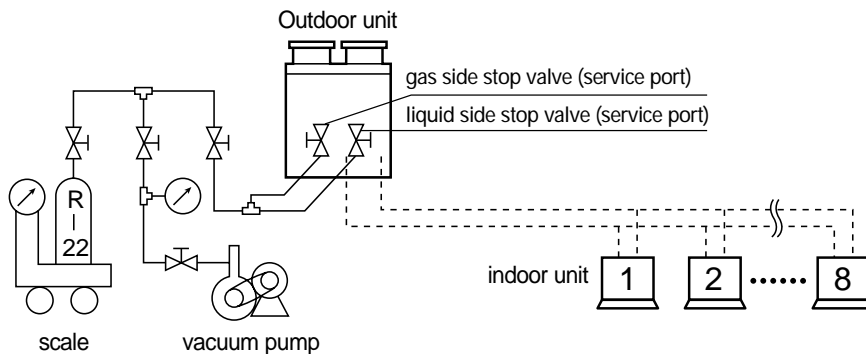

## 8. Charge/recovery of refrigerant

### 8-2. Additional refrigerant amount calculation method

(1) The amount of refrigerant filled in the outdoor when the product is delivered (on the base of piping 10 m)

(2) Additional amount of refrigerant as per the pipe diameter and length (liquid pipe based)

Pipe diameter (mm)	6.35	9.52	12.70(**040**~**075**)	12.70(**08**~**100**)
Additional amount of refrigerant(g/m)	50	80	120	140

(3) Additional refrigerant amount calculation method

$$\begin{aligned} \text{Additional refrigerant amount} &= 12.70 \text{ (liquid pipe /high pressure pipe diameter)} \times 120\text{g/m} \\ &+ 9.52 \text{ (liquid pipe /high pressure pipe diameter)} \times 80\text{g/m} \\ &+ 6.35 \text{ (liquid pipe /high pressure pipe diameter)} \times 50\text{g/m} \end{aligned}$$

(4) Example of additional refrigerant amount calculation

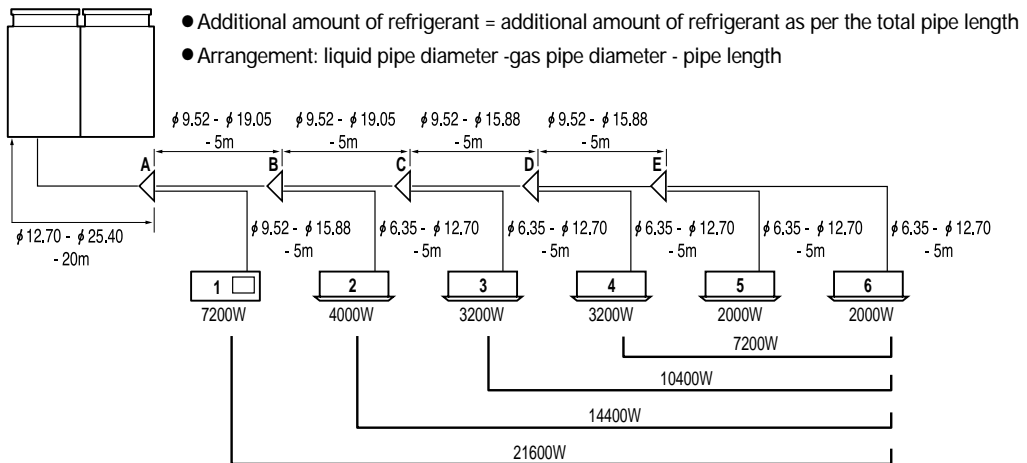

$$\begin{aligned} \text{Additional amount of refrigerant} &= (\phi 12.70 \text{ liquid pipe length} \times 120\text{g/m}) + (\phi 9.52 \text{ liquid pipe length} \times 80\text{g/m}) + \\ &(\phi 6.35 \text{ liquid pipe length} \times 50\text{g/m}) \\ &= (20\text{m} \times 120\text{g/m}) + (25\text{m} \times 80\text{g/m}) + (25\text{m} \times 50\text{g/m}) \\ &= 5650\text{g} - \alpha \end{aligned}$$

### 8-3. Recovery of refrigerant

- (1) Close the service valve of liquid side and then press the refrigerant recovery button on outdoor PCB.**
- (2) When the low pressure is getting lower enough, close the service valve to press the refrigerant recovery button again or press key 3. Pressing the button stops the compressor.**
- (3) When total amount of refrigerant in the pipe is more than 15kg, the refrigerant may not be recovered completely even though the refrigerant recovery (pump down) is performed. So care must be taken.**
- (4) The pump down time shall not exceed 5 minutes.**



## 9. Testing operation

### ■ Cautions for operation

- Put the power 6 hours before initial operation so that the crank case heater may be heated.
- When doing the retry of initial operation after main power off, start the operation 2 and half hours after power on.
- If the heater is not heated, the operation can not be started for 2 hours after power on for the protection of compressor. (Ch displays on the PCB display part at the time.)

### (1) Check the power between outdoor unit and distribution board.

#### (3 phase tester recommended)

- Compressor power : L1(R) L2(S) L3(T) - red white black (Care must be taken so that the color and order may not be changed.)
- 220V power: L N

### (2) Check the indoor unit

- ① Check whether the power source of each indoor unit and the communication cables are correctly connected. (Communication cable marked as F1, F2)
  - If the communication cable is changed each other with the power cable, it might cause the damage to PCB.
  - There is no color marking on the power supply cable but be sure to check the color of communication cable since the cable has the polarity.
- ② Check whether the addresses are correctly assigned to each indoor unit.
  - The address switch is available from "0".
  - The address of each indoor unit shall be assigned differently.
- ③ Check whether the connections for temperature sensor, electronic expansion valve and drain pumps are all connected.

### (3) Check the outdoor unit

- ① Set the numbers of indoor unit on the outdoor unit PCB.
  - If there are all 3 outdoor units, set so that the arrow mark is shown on "3".
- ② Check on the outdoor unit PCB whether the outdoor unit capacity code and Dip switch are correct. (It is delivered with the setting in factory and so there is not necessary to set separately).

### (4) Once the check of power supply, indoor and outdoor unit is completed, connect to the outdoor unit the PC in which the A/S program is installed, and then put the power of the outdoor unit on.

### (5) Once the power is on to the outdoor unit, the outdoor performs the tracking to check the connected indoor unit and options.

- At the time the left side of outdoor unit PCB display part shows the detection of communication response with 0 - F address and if there comes the response, the address of indoor unit responded displays on the right side display.

### (6) Once the tracking of approximately 20 seconds is completed, the following steps are proceeded when comparing the numbers of indoor units set in PCB and those responded through communication, if they are same, but if they are not same, E2 Error displays on the PCB display.

- For E2 error, check whether the indoor unit set switch on PCB is correct or whether the installation and address setting is correct if there is an indoor unit not responding.
- Press Key3 after check and retry the Tracking.



- (7) If Ch displays on the PCB display after tracking, it is the state of compressor not preheated, which means the operation is possible after 2 and half hours. (Supply the power and preheat the compressor).**
- (8) If the preheating of compressor is completed, the communication is performed between indoor unit connected and options. It is the normal at the time when the address on the right display is shown as many as shown on the left side display.**
- (9) Check through the PC connected with outdoor unit whether the data is correct from temperature sensor and electronic expansion valve.**
- (10) Once the above process is all completed, press the test operation button on PCB.**
- Check before pressing key whether all the service valves are open.
- (11) Check the high and low pressure through the manifold gauge .**
- Refer to the pressure table separately provided as per the outdoor temperature and piping length.
  - Since the high pressure and low pressure varies at the initial operation, take the input data 20 minutes after the start of compressor at least.
  - Since the compressor may reciprocate if there is loud noise or if the low and high pressure do not vary, check the power L1(R)-L2(S)-L3(T) from (1). If there is not trouble in the power but the problems continues to occur, check the wire connected to the compressor.
- \*Caution\*** ● Neglect the RCS on the compressor power incoming and check the order of T1-L1(R)-red, T2-L2(S)-white, T3-L3(T)-black.
- (12) Check through the PC connected to the outdoor unit.**
- Check the temperature, RPM, power and opening of electronic expansion valve for each indoor unit.
  - Check whether the compressor discharge, condenser outlet temperature, outdoor fan are operated.
- (13) During the test operation, check whether error is shown on the outdoor PCB.**
- Test operation shall be continued for more than 2 hours continuously at least.
  - After the long initial operation of outdoor unit, check whether the condensate is well treated.
- (14) Press again the test button to complete the test operation. (Operation completion of whole rooms)**
- (15) If the test operation mode is completed, operate one indoor unit only in cooling mode.**
- The operation shall be continued for more than 30 minutes for one unit and then check the temperature of indoor unit connected through PC to check the leak of electronic expansion valve. If there is no problem, put off the indoor unit which is operating and operate another indoor unit to check the electronic expansion valve leak as in the above manner.

# 10. Cautions for refrigerant leaks

## 10-1. Introduction

The DVM system, like most other air conditioning systems, uses R-22 as its refrigerant. R-22 itself is an entirely safe non-toxic, non-combustible refrigerant but care must nevertheless be taken to ensure that the air conditioning facilities are installed in a room which is sufficiently large to avoid a \*dangerous concentration of refrigerant gas in the unlikely event of a serious leak in the system.

\* Dangerous concentration

Dangerous concentration means the maximum concentration of CFC gas which can be dealt quickly and with without damage to the person in the case of a leak of refrigerant into the air. The unit of measurement of the dangerous concentration is  $\text{kg/m}^3$  (the weight in kg of CFC gas in  $1\text{m}^3$  of air) for ease of calculation.  
 Dangerous concentration of R-22:  $0.3\text{kg/m}^3$

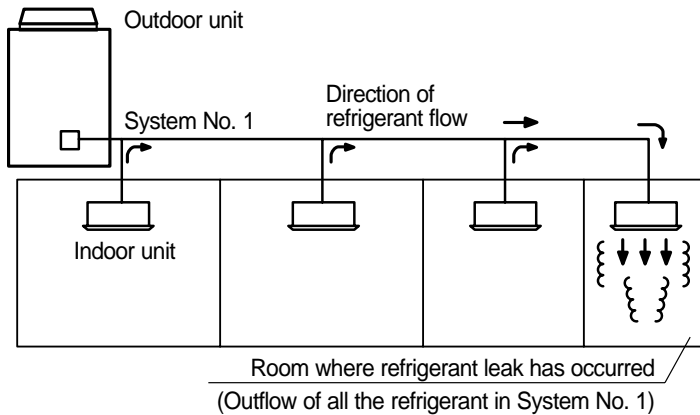

## 10-2. Procedure for checking dangerous

### ■ Concentration

Check the dangerous concentration in accordance with steps 1-4 below and take whatever action is necessary.

#### (1) Calculate the amount of refrigerant(kg) charged to each system separately.

$$\begin{array}{r}
 \text{(Amount of refrigerant in a} \\
 \text{single indoor unit system)} \\
 \downarrow \\
 \text{Amount of refrigerant with} \\
 \text{which the system is charged} \\
 \text{before leaving the factory}
 \end{array}
 +
 \begin{array}{r}
 \text{(Additional charging amount)} \\
 \downarrow \\
 \text{Amount of refrigerant added} \\
 \text{locally in accordance with the} \\
 \text{length or diameter of the} \\
 \text{refrigerant piping}
 \end{array}
 =
 \begin{array}{r}
 \text{Total amount of refrigerant(kg)} \\
 \text{in the system}
 \end{array}$$

**Note** ◆ Where a single refrigerant facility is divided into 2 entirely independent refrigerant systems then use the amounts of refrigerant with which each separate system is charged.

#### (2) Calculate the smallest room volume(m<sup>3</sup>)

In a case like the following calculate the volume of (1), (2) as a single room or as the smallest room.

1) Where there are no smaller room divisions

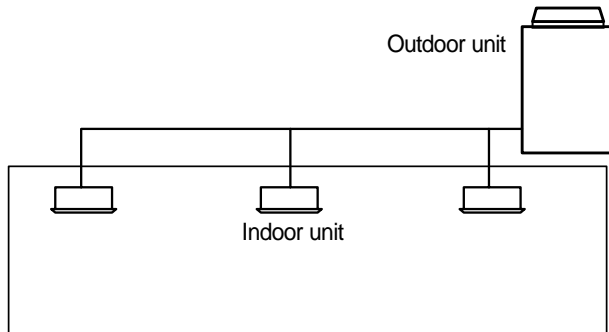

2) Where there is a room division but there is an opening between the rooms sufficiently large to permit a free flow of air back and forth. (Where there is an opening without a door or where there are openings above and below the door which are each equivalent in size to 0.15% or more of the floor area.)

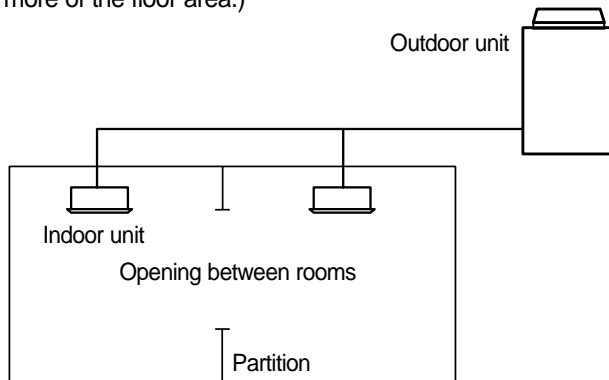



## 10. Cautions for refrigerant leaks

- 3) Where there is a gas leak detection alarm device linked to a mechanical ventilator in the smallest room then the next smallest room will become the measurement target.

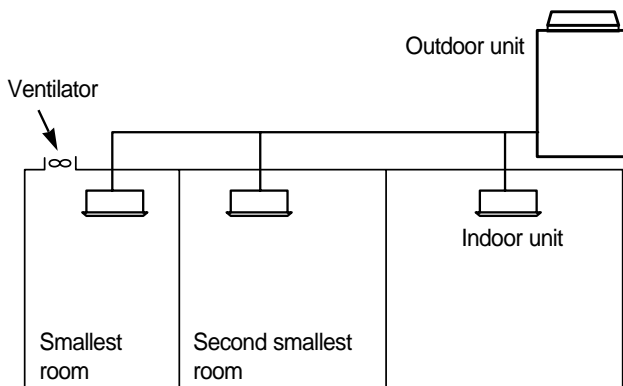

### (3) Calculate the refrigerant density using the results of the calculations in steps 1 and 2 above.

$$\frac{\text{Total volume of refrigerant in the refrigerant system}}{\text{Size(m}^3\text{) of smallest room in which there is an indoor unit installed}} \leq \text{Dangerous concentration(kg/m}^3\text{)}$$

- In the case of R-22: 0.3kg/m<sup>3</sup>

If the result of the above calculation exceeds the dangerous concentration level then make similar calculations for the second the third smallest room and so on until the result falls short of the dangerous concentration level.

**(4) Dealing with situations where the result exceeds the dangerous concentration level.**

Where the installation of a facility results in a concentration in excess of the dangerous concentration level then it may be necessary to revise the system design to some extent or else take one of the following courses of action:

**<Action 1> Making openings which will allow the air to flow freely into the room.**

Make openings above and below the door which are each equivalent in size to 0.15% or more of the floor area or make a doorless opening.

**<Action 2> Fit a mechanical ventilator linked to a gas leak detection alarm device.**

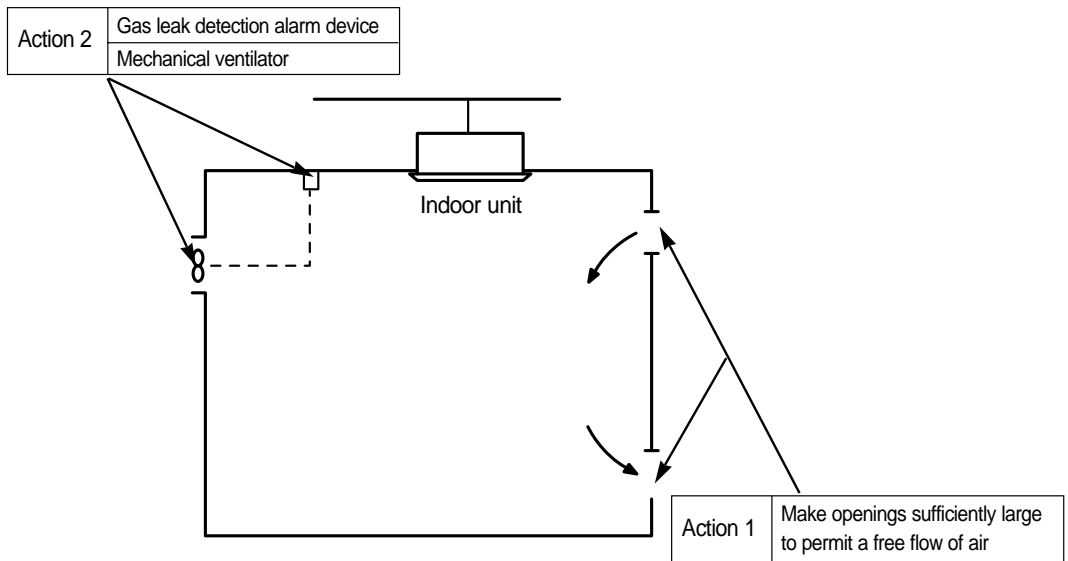



ELECTRONICS